

Power Management Products



10 IQ Products

Product Description	V12-T10-2
Product History	V12-T10-3
Product History Time Line	V12-T10-3
General Information	
Metering Selection Chart	V12-T10-4
Protective Relay Selection Chart	V12-T10-12
Technology Upgrades	
Power Xpert 4000/6000/8000 Series Meters	V12-T10-15
Power Xpert 2000 Series Meters	V12-T10-17
Power Xpert Multi-Point Meter	V12-T10-18
IQ 250/260	V12-T10-19
IQ 130/140/150	V12-T10-20
IQ 150S/250S	V12-T10-21
IQ 35M	V12-T10-22
Enclosed Meters	V12-T10-23
Current Products	
IQ Analyzer 6400/6600	V12-T10-24
IQ DP-4000/4100	V12-T10-25
IQ Energy Sentinel	V12-T10-26
IQ 230	V12-T10-27
MP-3000 Motor Protection	V12-T10-28
FP-5000 Feeder Protection	V12-T10-29
Digitrip 3000 (DT-3000)	V12-T10-30
Accessories	
IQ Flange	V12-T10-31
IQ 250-PMMAK	V12-T10-31
IQ DC Power Supply	V12-T10-31
IQ Cable	V12-T10-31
IQ Floor-Mounted Enclosure	V12-T10-31
Addressable Relay II	V12-T10-32
Power Modules	V12-T10-32
CTs	V12-T10-33
Discontinued Product—Recommended Replacement	
IQ 2000	V12-T10-36
IQ Analyzer 6000/6200	V12-T10-36
RTD Modules	V12-T10-36
IQ 1000 and IQ 1000 II	V12-T10-37
IQ Data Plus and IQ Data Plus II	V12-T10-37
IQ Data	V12-T10-37
IQ Generator	V12-T10-38
IQ 300	V12-T10-38
IQ 210/220	V12-T10-39
IQ 110/115	V12-T10-40
IQ Power Sentinel	V12-T10-41
IQ Multipoint Energy Submeter II	V12-T10-42
Further Information	V12-T10-43
Pricing Information	V12-T10-43

Electronic Metering and Protection



Power Management Products

Product Description

Eaton's electrical business IQ Metering and Protection group of Cutler-Hammer® series products are multifunctional communicating products based on microprocessor technology. They are designed to replace existing electromechanical devices and can be applied at low, medium and high voltage points in the electrical distribution system. These devices offer communications capabilities to link electrical distribution equipment to Eaton's PowerNet™ Power Management Software.

These products generally surpass capabilities available with older analog/electromechanical technologies. Depending on the features available from each device, information from these devices may be used to record and analyze power system and power quality events or problems and may improve power systems protection and coordination. With communications, these devices may be used for energy monitoring and management with trended data for use in future power system planning.

Product History

Originally a Westinghouse Product

In the early 1980s, power metering and protective relaying functions were performed by electro-mechanical devices. Analog meters and induction disk protective relays were found on virtually every switchgear lineup manufactured up to that time. With the maturing of solid-state electronics, microprocessor-based replacements for the electro-mechanical devices became available. These new devices provided increased functionality and flexibility, in a smaller space, for less cost. Westinghouse led the movement toward electronic metering and protection devices with the introduction of the IQ 2000 motor protection and control relay. In 1987, the IQ 2000 functions were split and two new products were introduced—the IQ 1000 and the IQ Data Plus. The IQ 1000 provided all current monitoring and motor protection functions and was developed for use on AMPGARD® medium voltage starters and low voltage motor control assemblies. The IQ Data Plus provided complete electrical metering and system voltage protection, and was developed for use on low and medium voltage switchgear, as well as AMPGARD and low voltage motor control assemblies.

The latest next generation addition to metering is the Power Xpert® Meter product series. The Power Xpert Meter power quality instrument monitors critical aspects of an electrical distribution system. This premier power quality metering instrument uses the latest in advanced technology to make it simple to use, powerful, scalable and highly flexible. Power Xpert Meters offer a new level of intuitive user interface design, presenting critical electrical distribution system information in a simple-to-navigate and easy-to-understand information architecture.

The Power Xpert Meter’s 4000/6000/8000 graphic display visualizes the information from up to 16 Power Xpert PQ instruments. The embedded Web server displays complex power quality data using standard Internet browsers and allows for device configuration from the browser. Both the local graphic display and the embedded Web server present real time, historical and event information in a browser-style graphical format to help the user interpret key circuit information such as current loading, voltage and power levels, power factor, energy usage, I/O status and power quality measurements, as well as harmonic plots, disturbance and transient waveforms, and an ITIC disturbance summary screen.

The Power Xpert 2000 Series Meter offers the same level of intuitive user interface design as the Power Xpert 4000/6000/8000 Meter with its embedded Web server to provide data logging and e-mail and the ability to visualize steady-state harmonic content as well as waveform recording that is critical for power quality analysis.

Since then, the IQ Metering and Protection product family has grown to include additional products for both metering and protective functions.

The IQ 250 and IQ 260 meters provide revenue grade accuracy with standard Modbus® communications and optional I/O capability.

The IQ 130/140/150 meters provide basic monitoring and energy metering for feeder applications and optional Modbus communications.

The IQ 35M provides energy monitoring at the panelboard level as well as retrofit applications.

The IQ 150S/250S provides wireless energy metering.

The enclosed metering offering adds flexibility in monitoring with Eaton’s latest line of meters where metering is needed.

The IQ DP-4000 and the IQ Analyzer provide advanced metering functions including the ability to monitor power quality parameters. IQ Energy Sentinels provide a low cost method to monitor energy usage for individual feeders or loads.

The Power Xpert Multi-Point Meter provides cost-effective and space-saving energy submetering for a wide variety of applications.

The MP-3000 added increased motor protection capability. The FP-5000, introduced in 2001, provides overcurrent protection for distribution feeders.

Product History Time Line

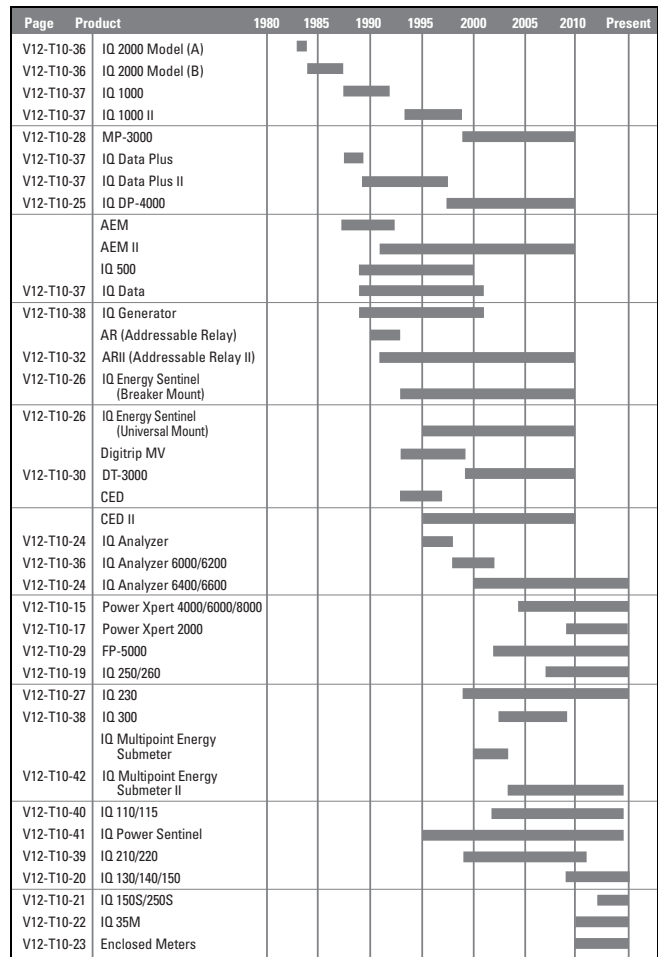

Metering Selection Chart—Dimensions in Inches (mm)

Device Name
Accessories
See Page V12-T10-31

Power Xpert 4000/6000/8000 Series



Power Xpert 2000



IQ 250/260 Series



Section Page Number	V12-T10-15	V12-T10-17	V12-T10-19
Electrical Parameters			
Volts	0.1% of RV + 0.02% FS	0.1% of RV	0.1% of RV
Amperes	0.05% of RV + 0.01% FS	0.1% of RV	0.1% of RV
Current range (% of nominal)	0.005–20A (400%)	0.1–200%	0.1–200%
Watts	0.1% of RV + 0.0025% FS	0.2% of RV	0.2% of RV
VARs	0.1% of RV + 0.0025% FS	0.2% of RV	0.2% of RV
VA	0.1% of RV + 0.0025% FS	0.2% of RV	0.2% of RV
PF-apparent	0.1%	0.2% of RV	0.2% of RV
PF-displacement	0.1%	—	—
Frequency	±0.01 Hz	±0.03 Hz	±0.03 Hz
THD-voltage	127th	40th ②③④⑤	40th ⑥
THD-current	127th	40th ②③④⑤	40th ⑥
Watt-hours	±0.2% per ANSI C12.20 0.2 Class ①	±0.2% per ANSI C12.20 0.2 Class ①	±0.2% per ANSI C12.20 0.2 Class ①
VAR-hours	±0.2% per ANSI C12.20 0.2 Class ①	±0.2% per ANSI C12.20 0.2 Class ①	±0.2% per ANSI C12.20 0.2 Class ①
VA-hours	±0.2% per ANSI C12.20 0.2 Class ①	±0.2% per ANSI C12.20 0.2 Class ①	±0.2% per ANSI C12.20 0.2 Class ①
Ampere-demand	0.05% of RV + 0.01% FS	±0.1% per ANSI C12.20 0.2 Class	±0.1% per ANSI C12.20 0.2 Class
Watt-demand	±0.2% per ANSI C12.20 0.2 Class ①	±0.2% per ANSI C12.20 0.2 Class ①	±0.2% per ANSI C12.20 0.2 Class ①
VAR-demand	±0.2% per ANSI C12.20 0.2 Class ①	±0.2% per ANSI C12.20 0.2 Class ①	±0.2% per ANSI C12.20 0.2 Class ①
VA-demand	±0.2% per ANSI C12.20 0.2 Class ①	±0.2% per ANSI C12.20 0.2 Class ①	±0.2% per ANSI C12.20 0.2 Class ①
Revenue accuracy	±0.2% per ANSI C12.20 0.2 Class ①	ANSI C12.20 (0.2%)	ANSI C12.20 (0.2%)
Individual ampere harmonics	85th ⑦	40th ③④⑤	—
Individual voltage harmonics	85th ⑦	40th ③④⑤	—
Interharmonics	Yes	—	—
Minimum and/or Maximum Values			
Volts	L-L, L-N, N-G, VAUX L-L	L-L, L-N	L-L, L-N
Current	A, B, C, N, G	A, B, C, N	A, B, C
Power	Watt, VAR, VA	Watt, VAR, VA	Watt, VAR, VA
Power Factor	Apparent/displacement	Apparent	Apparent
Frequency	Hertz	Hertz	Hertz
THD	Amperes/volts (L-L, L-N, AUX L-L)	Amperes/volts ②③④⑤	Amperes/volts ⑥
Demand values	kW, kVAR, kVA, amperes	kW, kVAR, kVA, amperes	kW, kVAR, kVA, amperes
Trend analysis	2 / 4 ⑧ / 8 ⑨ GB	256 / 512 ② / 768 ③④⑤ MB	128 KB ⑩
Event logging	2 / 4 ⑧ / 8 ⑨ GB	100,000 alarms/events with timestamp	⑩
Disturbance recording	2 / 4 ⑧ / 8 ⑨ GB 60 cycles per event	768 MB ④⑤ up to 64 cycles per event ④⑤	—

Notes

- ① Under typical operating conditions.
- ② PXM 2260 only.
- ③ PXM 2270 only.
- ④ PXM 2280 only.
- ⑤ PXM 2290 only.
- ⑥ IQ 260 only.

- ⑦ Individual values reported to 85th harmonic; anti-alias filtering prevents higher frequencies from distorting readings (see IEC 61000-4-7).
- ⑧ PMX 6000 only.
- ⑨ PXM 8000 only.
- ⑩ Optional.
- ⑪ At computer only.

- Legend:** PG = Programmable
 FS = Full scale
 RV = Read value
 Auxiliary voltage (optional) = Provides three additional voltage inputs to the meter: Va2, Vb2, Vc2.
 Interharmonics = Power Xpert Meter 6000/8000 supported.

Metering Selection Chart—Dimensions in Inches (mm), continued

Device Name
Accessories
See Page V12-T10-31

Power Xpert 4000/6000/8000 Series

Power Xpert 2000

IQ 250/260 Series



Section Page Number

V12-T10-15

V12-T10-17

V12-T10-19

Other Features

Storage	2 / 4 ^① / 8 ^② GB	256 / 512 ^③ / 768 ^④ MB Standard	128 KB for logging, up to 8 parameters every 15 minutes for 30 days
PG output relays	5 maximum	Optional (2) Form C, 5A or (4) Form A, 120 mA	Optional (2) Form C, 5A or (4) Form A, 120 mA
PG analog outputs	—	Optional (4) 4–20 mA or (4) 0–1 mA	Optional (4) 4–20 mA or (4) 0–1 mA
Discrete contact inputs	8	Optional (2) or (4)	Optional (2) or (4)
Analog inputs	—	—	—
Synch-input kW utility	Via status input	Via end of interval pulse with optional digital inputs	Via end of interval pulse with optional digital inputs
Auxiliary voltage ^⑤	Yes	—	—
kWh pulse initiator	Yes	Yes	Yes
Waveform display	Local/computer	^⑥	—
Waveform capture, samples/cycle	Yes, 512 (4096 oversampling)	Yes, up to 64 ^⑦ , up to 512 ^⑧	—
Frequency distribution display	—	—	—
Display type	LCD ^⑨	Red LED	Red LED
Display lines/character	Graphic (320 x 240 pixels)	3 lines, 4 characters	3 lines, 4 characters
Display character height	5.5 mm H x 4 mm W	0.56 (14.2) H	0.56 (14.2) H
Communications	Serial: Modbus RTU, Modbus ASCII Network: Modbus TCP, Ethernet TCP/IP, HTTP, SNMP, SMTP, FTP, DNP 3.0 ^⑩	Serial: Modbus RTU, Modbus ASCII, DNP 3.0 Network: Modbus TCP, BACnet/IP, Ethernet TCP/IP, HTTP, HTTPS, SNMP, SMTP	Serial: Modbus RTU, Modbus ASCII, DNP 3.0 Network: Modbus TCP via Power Xpert Gateway
Setup configuration	Via Web browser/display	Via Web browser/display	Via configuration software/display
Dimensions	Refer to TD02601007E	Refer to TD02601017E	Refer to TD02601016E
Operating temperature range	–20° to 60°C display unit –20° to 70°C meter base unit	–20° to 70°C	–20° to 70°C
Reference literature	TD02601007E	TD02601017E	TD02601016E

Notes

- ① PXM 6000 only.
- ② PXM 8000 only.
- ③ PXM 2260 only.
- ④ PXM 2270 only.
- ⑤ The auxiliary voltage option adds three additional voltage input channels to Power Xpert Meters.
- ⑥ At computer only.
- ⑦ PXM 2280 only.
- ⑧ PXM 2290 only.
- ⑨ Optional.

Legend: PG = Programmable
FS = Full scale
RV = Read value

Auxiliary voltage (optional) = Provides three additional voltage inputs to the meter: Va2, Vb2, Vc2.

Interharmonics = Power Xpert Meter 6000/8000 supported.

Metering Selection Chart, continued

Device Name
Accessories
See Page V12-T10-31

IQ 130/140/150 Series



IQ 150S/250S Series



IQ 35M Series



Section Page Number

V12-T10-20

V12-T10-21

V12-T10-22

Electrical Parameters

Volts	±0.25% of RV	0.1% of RV	0.4% +0.015% per °C deviation from 25°C
Amperes	±0.25% of RV	0.1% of RV	0.4% (5–100%), 0.8% (1–5%) +0.015% per °C from 25°C
Current range (% of nominal)	0.1–200%	0.1–200%	1–120%
Watts	0.5% of RV ^①	0.2% of RV	0.5% per ANSI C12.20 and IEC 62053-22 Class 0.5S
VARs	0.5% of RV ^①	0.2% of RV	2.0% per IEC 62053-23 Class 2
VA	0.5% of RV ^①	0.2% of RV	Calculated: vector sum of watts and VARs
PF-apparent	0.5% of RV ^①	0.2% of RV	Calculated: Watts / VAs
PF-displacement	—	—	—
Frequency	±0.03% Hz ^①	±0.03 Hz	±0.02 Hz
THD-voltage	—	—	—
THD-current	—	—	—
Watt-hours	±0.5% per ANSI C12.20 0.5 Class ^②	±0.2% per ANSI C12.20 0.2 Class	0.5% per ANSI C12.20 and IEC 62053-22 Class 0.5S
Var-hours	±0.5% per ANSI C12.20 0.5 Class ^②	±0.2% per ANSI C12.20 0.2 Class	±2.0% per IEC 62053-23 Class 2
VA-hours	±0.5% per ANSI C12.20 0.5 Class ^②	±0.2% per ANSI C12.20 0.2 Class	—
Ampere-demand	±0.5% per ANSI C12.20 0.5 Class ^②	±0.1% per ANSI C12.20 0.2 Class	—
Watt-demand	±0.5% per ANSI C12.20 0.5 Class ^②	±0.2% per ANSI C12.20 0.2 Class	0.5% per ANSI C12.20 and IEC 62053-22 Class 0.5S
VAR-demand	±0.5% per ANSI C12.20 0.5 Class ^②	±0.2% per ANSI C12.20 0.2 Class	2.0% per IEC 62053-23 Class 2
VA-demand	±0.5% per ANSI C12.20 0.5 Class ^②	±0.2% per ANSI C12.20 0.2 Class	Calculated: vector sum of watts and VARs
Revenue accuracy	ANSI C12.20 (0.5%)	ANSI C12.20 (0.2%)	0.5% per ANSI C12.20 and IEC 62053-22 Class 0.5S
Individual ampere harmonics	—	—	—
Individual voltage harmonics	—	—	—
Interharmonics	—	—	—

Minimum and/or Maximum Values

Volts	L-L, L-N	L-L, L-N	—
Current	A, B, C	A, B, C	—
Power	Watt, VAR, VA	Watt, VAR, VA	—
Power factor	Apparent ^①	Apparent	Apparent (low alert)
Frequency	Hertz ^①	Hertz	Hertz (out of range alert)
THD	Ampere/Volts	—	—
Demand values	kW, kVAR, kVA, amperes ^③	kW, kVAR, kVA, amperes	kW, kVAR, kVA; Maximum kW, kVAR, kVA
Trend analysis	^③	2 MB ^⑤	—
Event logging	^③	2 MB ^⑤	Logging on demand interval or Modbus command ^④
Disturbance recording	—	—	—

Notes

- ① IQ 140 and IQ 150.
- ② IQ 150 only.
- ③ At computer only.
- ④ Optional.
- ⑤ IQ 250S only.

Legend: PG = Programmable
FS = Full scale
RV = Read value

Metering Selection Chart, continued

Device Name
Accessories
See Page V12-T10-31

IQ 130/140/150 Series



IQ 150S/250S Series



IQ 35M Series



Section Page Number	V12-T10-20	V12-T10-21	V12-T10-22
Other Features			
Storage	—	2 MB ^②	10 registers (16 bit) by 5760 entries each (115 KB) ^①
PG output relays	—	—	—
PG analog outputs	—	—	—
Discrete contact inputs	—	—	2 pulse inputs with BACnet
Analog inputs	—	—	—
Synch-input kW Utility	—	—	Optional demand synchronization via Modbus
Auxiliary voltage ^③	—	—	—
kWh pulse initiator	^①	Yes	Yes
Waveform display	—	—	—
Waveform capture	—	—	—
Frequency distribution display	—	—	—
Display type	Red LED	Red LED	Backlit LCD
Display lines/character	3 lines, 4 characters	3 lines, 4 characters	2 lines by 5 characters each (full alphanumeric top row)
Display character height	0.56 (14.2) H	0.56 (14.2) H	7.5 mm
Communications	Serial: Modbus RTU, Modbus ASCII ^① Network: Modbus TCP ^①	Serial: Modbus RTU, Modbus ASCII, DNP 3.0 Network: Modbus TCP, wired or wireless	Serial: Modbus RTU ^① , BACnet MS/TP ^① Network: Modbus TCP via Power Xpert Gateway
Setup configuration	Via configuration software/display	Via configuration software/display	Via display/configuration software
Dimensions	4.85 (123.2) H x 4.85 (123.2) W x 4.97 (126.2) D	7.90 (200.7) H x 7.50 (190.5) W x 3.10 (78.7) D	3.60 (91.4) H x 4.20 (106.7) W x 2.30 (58.4) D
Operating temperature range	-20 to 70°C	-20 to 70°C	-20 to 70°C
Reference literature	TD02601015E	TD02601019E	TD02601015E

Notes

- ^① Optional.
- ^② IQ 250S only.
- ^③ The auxiliary voltage option adds three additional voltage input channels to Power Xpert Meters.

Legend: PG = Programmable
FS = Full scale
RV = Read value

Metering Selection Chart—Dimensions in Inches (mm), continued

Device Name
Accessories
See Page V12-T10-31

IQ Analyzer 6400/6600 Series



IQ DP-4000 Series



IQ 230 Series



Section Page Number

V12-T10-24

V12-T10-25

V12-T10-27

Electrical Parameters

Volts	±0.2% FS ①	±0.3% FS	±0.5% FS
Amperes	±0.2% FS ①	±0.3% FS	±0.5% FS
Current range (% of nominal)	3–800%	10–250%	1–200%
Watts	0.4% FS, 6 RV ②	±0.6% FS	±1.0% FS
VARs	0.4% FS, 6 RV ③	±0.6% FS	±1.0% FS
VA	0.4% FS, 6 RV ②	±0.6% FS	±1.0% FS
PF-apparent	0.8% FS ①	±1.0% FS	±2.0% FS
PF-displacement	0.8% FS ①	±1.0% FS	±2.0% FS
Frequency	0.04% ① or 0.01 Hz	±0.17% FS	±0.1% Hz
THD-voltage	50th	31st	—
THD-current	50th	31st	—
Watt-hours	0.5% RV ②	±0.6% FS	±1.0% per ANSI C12
Var-hours	1% RV ③	±0.6% FS	±1.0% per ANSI C12
VA-hours	0.5% RV ②	±0.6% FS	±1.0% per ANSI C12
Ampere-demand	±0.2% FS ①	±0.3%	±0.5% per ANSI C12
Watt-demand	±0.4% FS ①	±0.6%	±1.0% per ANSI C12
VAR-demand	±0.4% FS ①	±0.6%	±1.0% per ANSI C12
VA-demand	±0.4% FS ①	±0.6%	±1.0% per ANSI C12
Revenue accuracy	ANSI C12.20 (0.5%)	—	ANSI C12.1 (1%)
Individual ampere harmonics	50th	—	—
Individual voltage harmonics	50th	—	—
Interharmonics	—	—	—

Minimum and/or Maximum Values

Volts	L-L, L-N	L-L, L-N	L-L, L-N
Current	A, B, C, N, G	A, B, C	A, B, C
Power	Watt, VAR, VA	Watt, VAR, VA	Watt, VAR, VA
Power factor	Apparent/displacement	Apparent/displacement	Apparent/displacement
Frequency	Hertz	Hertz	Hertz
THD	Amperes/volts	Amperes/volts	—
Demand values	All	All	All
Trend analysis	Time/date	2 alarms	④
Event logging	504 events w/timestamp	④	④
Disturbance recording	10 waveform events	—	—

Notes

- ① From 3–300% of FS.
- ② At unity power factor and 5–300% of FS.
- ③ At a power factor ≤ 0.5 and 5–300% of FS.
- ④ At computer only.

Legend: PG = Programmable
FS = Full scale
RV = Read value

Metering Selection Chart—Dimensions in Inches (mm), continued

**Device Name
Accessories
See Page V12-T10-31**

IQ Analyzer 6400/6600 Series



IQ DP-4000 Series



IQ 230 Series



Section Page Number	V12-T10-24	V12-T10-25	V12-T10-27
Other Features			
Storage	90 KB	15 parameters	—
PG output relays	(4) 10A Form C ^①	(3) 10A Form C ^②	(2) 100 mA Form A
PG analog outputs	(4) 0–10/4–20 mA	—	—
Discrete contact inputs	(3) +30 Vdc differential	(1) kW Demand ^②	(2) +30 Vdc differential
Analog inputs	(1) 0–20/4–20 mA	—	(1) 4–20 mA
Synch-input kW Utility	At device or via communications	At device or via communications ^②	Via communications only
Auxiliary voltage	—	—	—
kWh pulse initiator	Yes	Yes ^②	Yes
Waveform display	Local ^② /computer	—	—
Waveform capture, samples/cycle	Yes, 128	—	—
Frequency distribution display	Local ^② /computer	—	—
Display type	Graphic LCD with LED backlight	7 Segment LED	Backlit LCD
Display lines/character	7 lines, 147 characters	1 line, 7 characters	4 lines, 20 characters
Display character height	Up to 7 lines	1 line	1.60 (40.6) H x 0.09 (2.3) W
Communications	Serial: INCOM ^③ Network: via Power Xpert Gateway ^③	Serial: INCOM ^③ Network: via Power Xpert Gateway ^③	Serial: INCOM, Modbus RTU ^④ Network: via Power Xpert Gateway
Setup configuration	Via configuration software/display	Via configuration software/display	Via configuration software/display
Dimensions	Refer to TD1702BTE	Refer to TD1703ATE	Refer to TD1706ATE
Operating temperature range	–20° to 70°C	–20° to 70°C	0° to 50°C
Reference literature	TD1702BTE	TD1703ATE	TD1706ATE

Notes

- ① Relays programmable to operate on any measured function.
- ② Optional.
- ③ An IPONI is required.
- ④ IQ 230M only.

Legend: PG = Programmable
FS = Full scale
RV = Read value

Metering Selection Chart—Dimensions in Inches (mm), continued

Device Name
Accessories
See Page V12-T10-31

Power Xpert Multi-Point Meter



IQ Energy Sentinel



Section Page Number

V12-T10-18

V12-T10-26

Electrical Parameters

Volts	±0.2% RV	—
Amperes	±0.2% RV	—
Current range (% of nominal)	—	—
Watts	±0.5% RV	±1.0% FS
VARs	±0.5% RV	—
VA	±0.5% RV	—
PF-apparent	±0.5% RV	—
PF-displacement	—	—
Frequency	±0.1 Hz	—
THD-voltage	—	—
THD-current	—	—
Watt-hours	±0.5% per ANSI C12.20 0.5 class	±1.0% FS
VAR-hours	±0.5% per ANSI C12.20 0.5 class	—
VA-hours	±0.5% per ANSI C12.20 0.5 class	—
Ampere-demand	—	—
Watt-demand	±0.5% per ANSI C12.20 0.5 class	±1.0% FS
VAR-demand	±0.5% per ANSI C12.20 0.5 class	—
VA-demand	±0.5% per ANSI C12.20 0.5 class	—
Revenue accuracy	ANSI C12.20 (0.5%)	—
Individual ampere harmonics	—	—
Individual voltage harmonics	—	—
Interharmonics	—	—

Minimum and/or Maximum Values

Volts	L-L, L-N	—
Current	A, B, C	—
Power	Watts, VAR, VA	—
Power factor	Apparent	—
Frequency	Hertz	—
THD	—	—
Demand values	Watts (Delivered & Received), Watts (Q1–Q4), VA (Q1, Q4), VA (Q2, Q3)	—
Trend analysis	Interval data	①
Event logging	20 latest events and historical	①
Disturbance recording	—	—

Note

① At computer only.

Legend: PG = Programmable
FS = Full scale
RV = Read value

Metering Selection Chart—Dimensions in Inches (mm), continued

Device Name
Accessories
 See Page V12-T10-31

Power Xpert Multi-Point Meter

IQ Energy Sentinel



Section Page Number	V12-T10-18	V12-T10-26
Other Features		
Storage	256 MB standard, 2 GB optional	—
PG output relays	1 standard, 8 each module ①	—
Discrete contact inputs	3 standard, 8 each module ①	—
Analog inputs	—	—
Synch-input kW utility	Via communications and digital input	Via communications only
Auxiliary voltage	—	—
kWh pulse initiator	Aggregate or main-digital output, LED output on meter modules (accuracy check)	—
Waveform display	—	—
Waveform capture	—	—
Frequency distribution display	—	—
Display type	LCD color touchscreen	—
Display lines/character	6-inch diagonal	—
Display character height	Graphics	—
Communications	Serial: Modbus RTU ① Network: Modbus TCP, BACnet/IP, Ethernet TCP/IP, HTTP, HTTPS, SNMP, SMTP, SFTP	Serial: INCOM Network: via Power Xpert Gateway
Setup configuration	Via PXMP configuration software	Via configuration software
Dimensions	Refer to TD150006EN	Refer to TD1707TE
Operating temperature range	-20° to 70°C	-25° to 70°C
Reference literature	TD150006EN	TD1707TE

Note
 ① Optional.

Legend PG = Programmable
 FS = Full Scale
 RV = Read Value

Protective Relay Selection Chart

DT-3000



FP-5000





MP-3000



For Further Details and Information,
See TD02600001TE.

Technical Data Number	Device Name	IEEE Device Number	TD.17.10.T.E	TD02602003E	TD.17.11.T.E
Protection Functions					
Directional power	32			■	
Phase directional	67			■	
Ground directional	67N			■	
Phase inst. OC	50	■	■	■	■
Phase TOC	51	■	■	■	■
Calc. residual ground IOC	50G			■	
Calc. residual ground TOC	51G			■	
Ground inst. OC (measured)	50G (N)	■	■	■	
Ground TOC (measured)	51G (N)	■	■	■	■
Phase voltage restrained OC	51VR			■	
No. of curves (ANSI/IEC/thermal)			11	10	1
TOC time reset				■	
Negative sequence OC (unbalance)	46			■	■
Negative sequence voltage	47			■	
Overvoltage	59			■	
Undervoltage	27			■	
Underfrequency	81U			■	
Overfrequency	81O			■	
Breaker failure	50BF			■	
Zone interlocking			■	■	
Thermal overload	49				■
Locked rotor	49S/51				■
Jam/stall	51R				■
Cold load pickup				■	
Loss of load					■
Power factor	55			■	
Control Functions					
Synchronization check	25			■	
Remote open/close		■	■	■	Trip only
Programmable I/O		■	■	■	■
Programmable logic				■	
Multiple setting groups				■	
Number of starts limit					■
Starts per hour					■
Time between starts					■
Emergency restart					■
Reduced voltage starting					■
Trip lockout		■	■	■	■

Protective Relay Selection Chart, continued

		DT-3000 	FP-5000 	MP-3000 
For Further Details and Information, See TD02600001TE.	Device Name			
Technical Data Number	IEEE Device Number	TD.17.10.T.E	TD02602003E	TD.17.11.T.E
Metering Functions				
Amperes		■	■	■
Ampere demand		■	■	
Volts			■	
Phase angle current voltage			■	
Positive, negative and zero sequence			■	
Watts			■	
Watt demand			■	
Watt-hour			■	
VARs			■	
VAR-demand			■	
VAR-hour			■	
VA			■	
VA-demand			■	
VA-hour			■	
Frequency			■	
Trending (load profile)			■	
Minimum/maximum recording			■	
Monitoring Functions				
Trip circuit monitor			■	
Breaker wear			■	
Failure to close			■	
Oscillography			■	
Sequence of events			■	■
Trip target data		■	■	■
Clock			■	■
Number of starts				■
Acceleration time				■
RTD temperature				■
Hottest RTD				■
Communications				
Local HMI		■	■	■
Local communication port RS-232			■	
Local communication port RS-485			■	
Remote communication port		■	■	■
FSK		■	■	Optional
Addressable		■	■	■
Protocols				
INCOM™		■	■	■
Modbus			■	

Protective Relay Selection Chart, continued)

DT-3000



FP-5000



MP-3000



For Further Details and Information,
See TD02600001TE.

Technical Data Number	Device Name	TD.17.10.TE	TD.17.30.TE	TD.17.11.TE
	IEEE Device Number			
Construction				
Panel-mount case		■	■	■
Drawout		Optional	■	Optional
Operating temperature range		-30°C to +55°C	-40°C to +60°C	-20°C to +60°C
Power supply options		120–240 Vac	48–125 Vac/Vdc	120–240 Vac
		24–250 Vdc	100–240 Vac/Vdc	
Dual source power supply		Optional		
AC current inputs		■	■	■
AC voltage inputs			■	
Wye PTs			■	
Delta/open delta PTs			■	
Binary inputs		1	8	2
Alarm outputs		2 Form C	2 Form C	3
Trip outputs		2	5	1
Analog outputs			Optional	1
Local display		■	■	■
LEDs (local targets)		■	■	■
Standards				
ANSI		■	■	■
IEC		■	■	■
UL®		■	■	■
CE		DT-3030 only	■	
CSA®		■	■	■

Power Xpert 4000/6000/8000 Series Meters



Power Xpert 4000/6000/8000 Series Display and Meter

General Description

The Power Xpert Meter 4000/6000/8000 Series monitors the critical aspects of an electrical distribution system. This premier power quality metering instrument is simple to use, powerful, scalable and highly flexible.

The Power Xpert Meter 4000/6000/8000 offers a new level of intuitive user interface design, presenting critical electrical distribution system information in simple-to-navigate and easy-to-understand information architecture. The Power Xpert Meter 4000/6000/8000 graphic display visualizes the information from up to 16 meter modules. The embedded Web server displays complex power quality data using standard Internet browsers and allows for device configuration from the browser.

Both the local graphic display and the embedded Web server present real time, historical and event information in a browser-style graphical format to help the user interpret key circuit information, such as:

- Current loading
- Voltage and power levels
- Power factor
- Energy usage
- I/O status
- Power quality measurements
- Harmonic plots
- Disturbance and transient waveforms
- ITIC disturbance summary screen

The Power Xpert Meter 4000/6000/8000 graphic display uses a simple “twist and click” navigation control dial to easily navigate the menus and drill down into increasing levels of important detail. A “back” key enhances the browser-like navigation of the graphic display.

The Web server provides the energy and demand readings required to help manage the cost of energy. It also provides critical information regarding power quality, such as harmonic distortion, flicker, crest factor, K-factor and more.

Note: Features and functionality may vary depending on the meter model and options being used. Review the Features and Benefits chart on **Page V12-T10-16** for details.

Catalog Number Selection

Power Xpert 4000/6000/8000 Meter

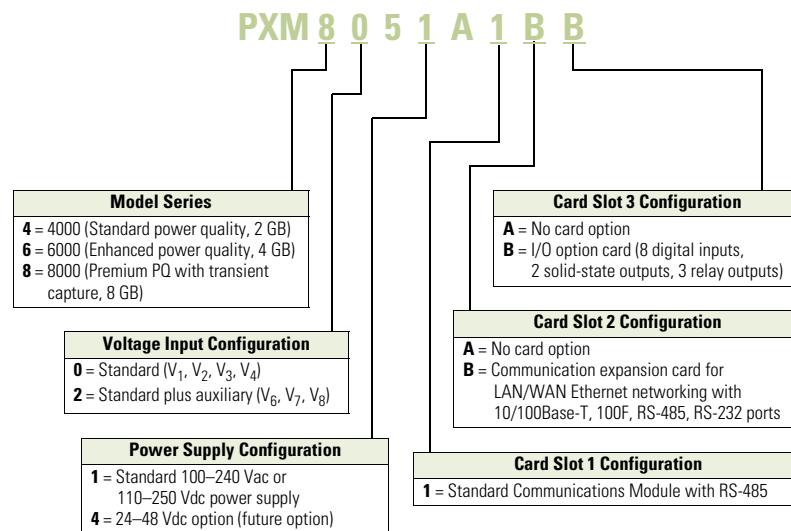

Example 1: **PXM8251A1BB** (PXM 8000 meter, w/ VAUX, std. pwr., com. exp. and I/O cards)
 Example 2: **PXM6251A1BA** (PXM 6000 meter, w/ VAUX, std. pwr., com. exp. card)

Accessories

Power Xpert Meter 4000/6000/8000

Description	Catalog Number
Graphic display module	PXD-MMG
Communication expansion card for LAN/WAN Ethernet networking: 100FX fiber-optic, 10/100T, RS-485, RS-232	PXMCE-B ①
Digital I/O card: eight digital input, two solid-state output, three relay output	PXMIO-B ①
Panel mounting bracket assembly for back-to-back meter to graphic display mounting	PX-PMBA
Panel mounting bracket assembly for retrofitting a graphic display to an IQ Analyzer cutout	PX-PMBB
Panel mounting bracket assembly for reduced graphic display rear clearance	PX-PMBC
Power Xpert Meter 4000 to 6000 license upgrade key	PXM-4KUPG

Notes

① These items can be ordered separately or preinstalled in the meter by selecting option B in the model number. Communication cable (standard Modbus RTU) is not included in the package for meter module connection.

Features and Benefits

Power Xpert 4000/6000/8000 Meters

Feature	Power Xpert			Benefit
	4000	6000	8000	
General				
Embedded Web server	■	■	■	Use a standard Web browser to monitor and manage the meter over the network, Internet
TOU metering support	■	■	■	Time of usage can be set up to support 4 different schedules
Firmware flash update support	■	■	■	Enables you to flash the meter with the latest firmware updates
Self-learning capability (characterizes “normal” per circuit)	■	■	■	The meter can automatically adjust to the environment and alarm only when “real” events occur
Power, Energy and Demand				
Voltage, current: per phase minimum, maximum, average, trend graph analysis, export, print	■	■	■	Review voltage and current trends, export, print and analyze parameters right on the meter or external software
Energy and demand plot comparisons month-to-month, week-to-week	■	■	■	Plot two months or two weeks for vivid energy or demand comparison
Power: power factor, apparent, real, reactive, frequency	■	■	■	Review power usage and power factor and avoid potential PF penalties
Energy, demand: forward, reverse, net, sum, tou, profile, previous month comparison, graph analysis, export, print	■	■	■	Keep track of your energy usage, compare time of usage and usage against previous month, identify peaks to conserve energy usage
Power Quality Analysis				
Statistical analysis (min., max., average)	■	■	■	Review statistical trends, identify past and future problem areas
Sag and swell monitoring, management and recording	■	■	■	Capture electrical sags and swells and analyze the waveforms
Symmetrical Components: Zero, Negative, Positive	■	■	■	Analyze possibly unbalanced three-phase power systems
Low frequency transient detection and capture	■	■	■	Capture lower frequency transient waveforms for retrospective analysis or e-mailing
Sampling rate, maximum samples/cycle	4096 ^①	4096 ^①	100,000	Extremely high sampling rate will effectively capture impulsive transients
“Number of Nines” uptime data (e.g., 6 nines = 99.9999%)	■	■	■	Review uptime availability per cent
K-factor	■	■	■	Review the ratio of eddy current losses, e.g., when driving nonlinear and linear loads
Crest factor	■	■	■	Review the peak-to-average ratio of the waveform
Security				
Secure 5 level user access privileges	■	■	■	Define appropriate security access level per user
Communications and I/O				
Modbus TCP	■	■	■	Easy integration with standard protocol to power management and other software
Modbus RTU	■	■	■	Integrate meters to existing Modbus networks, daisy chain several (1–16) meters together
HTML	■	■	■	Communicate to the meter over the Internet via standard Web browser
SNMP (simple network management protocol)	■	■	■	Communicate with the meter via Simple Network Protocol; hook to existing NMS system
SMTP (simple mail transfer protocol)	■	■	■	Send e-mail messages via standard Simple Mail Transfer Protocol
FTP (file transfer protocol)	■	■	■	Access, copy, paste, cut waveform capture files on the meter with an FTP Client
NTP (network time protocol)	■	■	■	Network Time Protocol support enables the meter to synchronize time over the network up to the 1 millisecond resolution
COMTRADE, open IEEE Standard file format for Waveform capture export	■	■	■	Import waveform captures in standard IEEE (C37.111-1999) COMTRADE file format to third-party software
DNP 3.0 over Ethernet (Distributed Network Protocol)	■	■	■	Communicate with the meter via DNP 3.0 over Ethernet; hook to existing utility systems
Trend measurements CSV file export	■	■	■	Easily export trend measurements to third-party applications, e.g., Microsoft Excel in standard CSV file format
I/O (8 digital inputs, 3 relay outputs, 2 solid-state KYZ outputs)	■	■	■	The Power Xpert I/O Card is extremely flexible and can be used in a large variety of different applications. Digital inputs and relay outputs can be programmed to interact during various conditions defined by the user. Various third-party devices, such as alarm, pulse meters, trip units, sensors can be easily integrated to the Power Xpert Meter. Triggers and events can be tied to the meters standard functions such as e-mail, logs and trends

Notes

^① Delta-Sigma A/D oversampling rate.

These specifications are subject to change without notice and represent the maximum capabilities of the product with all options installed. This is not a complete feature list. Features and functionality may vary depending on selected options, firmware version and product model. Please refer to the technical data sheet and User Manual for detailed specifications.

Power Xpert 2000 Series Meters



Power Xpert 2000 Series

General Description

The Power Xpert Meter 2000 Series power quality instrument monitors the most critical aspects of an electrical distribution system. This premier power quality metering instrument uses the latest in advanced technology to make it simple to use, powerful, scalable and highly flexible. The Power Xpert Meter 2000 offers the same level of intuitive user interface design as the Power Xpert Meter 4000/6000/8000, presenting critical electrical distribution system information in a simple to navigate and easy-to-understand information architecture.

The embedded Web server displays comprehensive power quality data using standard Internet browsers and allows for device configuration from the browser. The embedded Web server presents real time, historical and event

information in a browser-style graphical format to help the user interpret information such as current loading, voltage and power levels, power factor, energy usage, I/O status, power quality measurements, as well as harmonic plots. The embedded Web server also allows for waveform capture and for visualizing steady-state harmonic content that is critical for power quality analysis.

The Web server provides the energy and demand readings required to help manage the cost of energy.

Catalog Number Selection

Power Xpert 2000 Meter

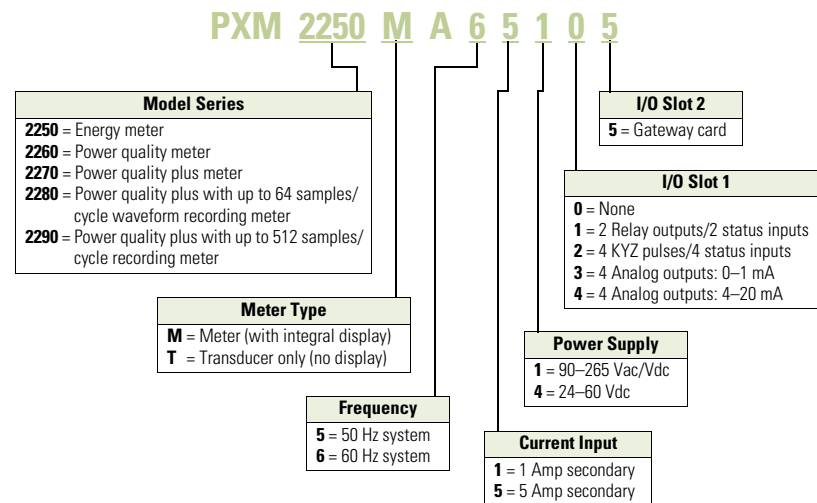

Example 1: **PXM2270MA65145** (PXM 2270 Meter/Display 60 Hz, 5A, 90–265 Vac/Vdc W/4A0)
 Example 2: **PXM2250MA65105** (PXM 2250 Meter/Display 60 Hz, 5A, 90–265 Vac/Vdc)

Accessories

Power Xpert 2000 Meter

Description	Catalog Number
Panel-mounting bracket assembly for retrofitting a PXM 2000 to an IQ Analyzer/IQ DP-4000/IQ Data cutout	IQ250-PMAK
PXM 2000 Gateway Card kit to upgrade an IQ 250/260 to a PXM 2000	PXM2000-GCK

Power Xpert Meter 2000 I/O Cards

Description	Catalog Number
PXM 2000 I/O card—2 relay outputs/2 status inputs	IQ250/260-I01
PXM 2000 I/O card—4 KYZ Pulses/4 status inputs	IQ250/260-I02
PXM 2000 I/O card—4 analog outputs—0–1 mA	IQ250/260-I03
PXM 2000 I/O card—4 analog outputs—4–20 mA	IQ250/260-I04

Power Xpert™ Multi-Point Meter



Power Xpert Multi-Point Meter

General Description

Eaton's Power Xpert Multi-Point Meter is an ANSI C12.20 revenue class Web enabled electronic submetering device that can be mounted in panelboards, switchboards or enclosures. When mounted in a panelboard or a switchboard, the Power Xpert Multi-Point Meter provides customers with an integrated power distribution and energy metering solution that saves space, reduces installation labor and lowers total cost. The Eaton Power Xpert Multi-Point Meter (PXMP Meter) offers a highly modular approach to high-density metering applications in electrical power distribution systems. The PXMP Meter is compatible with most three-phase industrial, commercial and single-phase residential low voltage electrical power systems. The PXMP is equipped with two Modbus RTU communication ports for local display and remote serial communications. The PXMP also has optional pulse input and digital output modules along with one standard digital output and three digital inputs. The PXMP Energy Portal Module is Web enabled, making it suitable for use with Ethernet networks and modems.

The Power Xpert Multi-Point Meter can measure up to any of the following number of circuits:

- Sixty single-phase, two-wire (single-pole)
- Thirty single-phase, three-wire (two-pole)
- Twenty three-phase, four-wire (three-pole)

The circuits listed above can be mixed provided that the total number of current sensors does not exceed 60.

The Power Xpert Multi-Point Meter can be used with three different ratings of current sensors: 100 mA, 10 mA or 333 mV. Switchboard/panelboard applications will use the 100 mA current sensors, which are highly accurate, self-protecting in the event of an open circuit condition under load and are supplied with an integral plug-in connector. The PXMP automatically detects the rating of the current sensor that is connected. The PXMP can also use 10 mA current sensors that were previously installed for IQMESII retrofit applications. Additionally the PXMP can use 333 mV split core current sensors for retrofit applications where metering has not previously existed. The 10 mA and 333 mV current sensors are also self-protecting in the event of an open circuit condition under load.

Application Description

The Power Xpert Multi-Point Meter is ideally suited to handle submetering in low voltage power distribution equipment applications with the use of voltage and current transformers.

The Power Xpert Multi-Point Meter provides a cost-effective solution for residential or commercial metering installations, including:

- High-rise buildings
- Government institutions
- K-12, universities and campuses
- Office buildings
- Medical facilities
- Apartment and condominium complexes
- Airports
- Shopping malls
- Industrial sites
- Mixed-use facilities

Product Selection

Power Xpert Multi-Point Meter Products

Description	Catalog Number
Meter Bases and Meter Modules with ABCN Voltage Inputs	
PXMP meter base—three-phase with ABCN voltage inputs	PXMP-MB
PXMP meter module with six 100 mA inputs for use with PXMP current sensors	PXMP-MM100MA
PXMP meter module with six 10 mA inputs for use with IQMESII current sensors	PXMP-MM10MA
PXMP meter module with six 333 mV inputs for use with 333 mV current sensors	PXMP-MM333MV
Meter Bases and Meter Modules with ABN Voltage Inputs	
PXMP meter base—single-phase, three-wire with ABN voltage inputs	PXMP-MB-AB
PXMP meter module with six 100 mA inputs for use with PXMP current sensors	PXMP-MM100MA-AB
PXMP meter module with six 10 mA inputs for use with IQMESII current sensors	PXMP-MM10MA-AB
PXMP meter module with six 333 mV inputs for use with 333 mV current sensors	PXMP-MM333MV-AB
IO Modules	
PXMP meter pulse input module with eight inputs	PXMP-PIM
PXMP meter digital output module with eight outputs	PXMP-DOM
Communication Module	
PXMP meter energy portal module	PXMP-EPM
Current Sensor Kits	
KIT, PXMP CS125 sensor, quantity of 3	PXMP-CS125-3
KIT, PXMP CS250 sensor, quantity of 3	PXMP-CS250-3
KIT, PXMP CS400 sensor, quantity of 3	PXMP-CS400-3
Current Sensor Cable Kits	
KIT, PXMP sensor cable, 4 ft (1.2m), quantity of 3	PXMP-SC4-3
KIT, PXMP sensor cable, 6 ft (1.8m), quantity of 3	PXMP-SC6-3
KIT, PXMP sensor cable, 8 ft (2.4m), quantity of 3	PXMP-SC8-3
KIT, PXMP sensor cable, 12 ft (3.7m), quantity of 3	PXMP-SC12-3
Current Sensor Extension Cable Kits	
KIT, PXMP sensor extension cable, 8 ft (2.4m), quantity of 3	PXMP-SCE-8-3
KIT, PXMP sensor extension cable, 16 ft (4.9m), quantity of 3	PXMP-SCE-16-3
Interface Modules	
PXMP current sensor interface module for 333 mV, kit X 3	PXMP-IM333MV-3

Note

Total sensor lead length must not exceed 28 ft (8.5m).

Power Xpert Multi-Point Meter Support Products

Description	Catalog Number
Communication cable, 1000 ft (305m), 600V insulation	IMPCABLE
PXMP meter display—6-inch color touchscreen (with cable)	PXMP-DISP-6
Power supply—single-phase 90–264 Vac, 24 Vdc at 2.5A	PSG60E
Power supply—three-phase 360–575 Vac, 24 Vdc at 2.5A	PSG60F
Power supply—three-phase 600 Vac, 24 Vdc	PSS55D

IQ 250/260 Electronic Power Meters



IQ 250/260 Electronic Power Meter

General Description

The IQ 250 and IQ 260 Meters provide capabilities you would not normally expect in affordable, ultra-compact meters, such as fast sampling rate and accurate metering for a full range of power attributes. Providing the first line of defense against costly power problems, Eaton's IQ 250 and IQ 260 electronic power meters can perform the work of an entire wall of legacy metering equipment using today's technology.

When space is at a premium, yet you need ANSI C12.20 accuracy, the IQ 250/ 260 series fit the bill. These meters are ideal for electrical equipment assemblies, machine control panels, such as panelboard and switchboard mains and feeders, low voltage metal-enclosed switchgear feeders and motor control centers. Requiring far less space than other meters with similar functionality, IQ 250/260 series fit into a standard ANSI or IEC cutout on a panelboard or other electrical equipment, and therefore fit easily into retrofit applications.

Catalog Number Selection

IQ 250/260 Meter

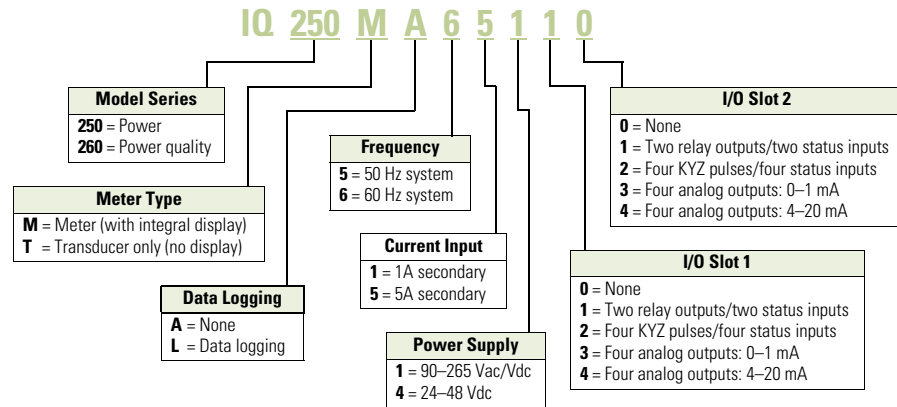

Accessories

IQ 250/260 Meter

Description	Catalog Number
Panel-mounting adapter for retrofitting an IQ 250/260 to an IQ Analyzer/IQ DP-4000/IQ Data cutout	IQ250-PMAX
PXM 2000 Gateway Card kit to upgrade an IQ 250/260 to a PXM 2000	PXM2000-GCK

IQ 250/260 Meter I/O Cards

Description	Catalog Number
IQ 250/260 I/O card—2 relay outputs/2 status inputs	IQ250/260-I01
IQ 250/260 I/O card—4 KYZ pulses/4 status inputs	IQ250/260-I02
IQ 250/260 I/O card—4 analog outputs—0–1 mA	IQ250/260-I03
IQ 250/260 I/O card—4 analog outputs—4–20 mA	IQ250/260-I04

**IQ 130/140/150 Series
Electronic Power Meters**



IQ 100 Electronic Power Meter

General Description

The IQ 100 Meter family provides capabilities you would not normally expect in affordable, compact meters, such as fast sampling rate and accurate metering for a full range of power attributes. Providing the first line of defense against costly power problems, Eaton's IQ 100 series electronic power meters can perform the work of an entire wall of legacy metering equipment utilizing today's technology.

When space is at a premium, yet you need ANSI C12.20 accuracy, the IQ 100 series fit the bill. These meters are ideal for electrical equipment assemblies, machine control panels, such as panelboard and switchboard mains and feeders, low voltage metal-enclosed switchgear feeders and motor control centers. Requiring far less space than other meters with similar functionality, IQ 100 series fit into a standard ANSI or IEC cutout on a panelboard or other electrical equipment, and therefore fit easily into retrofit applications.

Catalog Number Selection

IQ 130/140/150 Meters

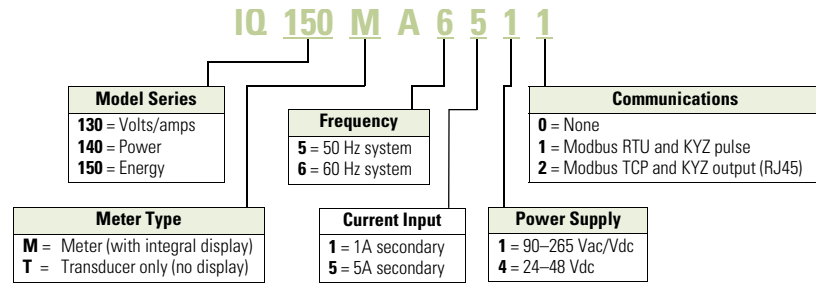

Accessories

IQ 130/140/150 Meters

Description	Catalog Number
Panel Mounting Adapter for retrofitting an IQ 100 to an IQ Analyzer/IQ DP-4000/IQ Data Cutout	IQ250-PMAK

IQ 150S/250S Self-Enclosed Electronic Meters



IQ 150S/250S Self-Enclosed Electronic Meters

Catalog Number Selection

IQ 150S/250S Meter

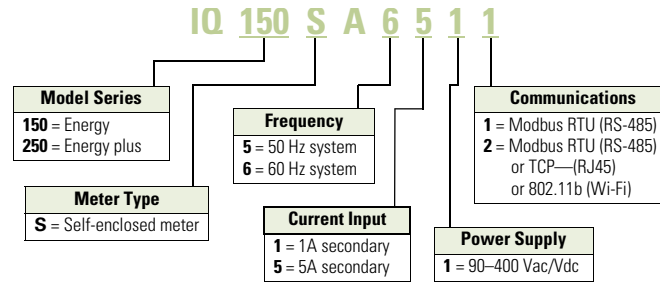

General Description

With energy costs skyrocketing, you need the ability to verify the accuracy of utility billing and allocation of energy costs among business units, different manufacturing areas or facilities, and tenants. Production equipment and IT systems are vulnerable to power anomalies; therefore, you must ensure that power is always up to specifications. If your infrastructure is an established facility, you may not currently have metering or may have addressed these concerns by deploying a variety of analog gauges and meters—one for volts, one for amperes and so on, with separate meters for each measurement.

If you're planning an upgrade or a new power infrastructure, no doubt you would like to capitalize on the latest technology to improve upon that cumbersome architecture and its patchwork view.

IQ 35M



IQ 35M

General Description

The Eaton IQ 35M Meter is a DIN rail meter that combines exceptional performance and easy installation to deliver a cost-effective solution for energy and power monitoring applications, as well as sub-metering applications. Most models include pulse output, alarm contact and phase alarms for true versatility. The BACnet version offers two digital inputs for accumulating other meter pulses in place of the digital output and alarm contact. The Modbus output options offer added flexibility for configuration and data analysis. The IQ 35M allows you to:

- Verify energy bills
- Make informed load shifting and shedding decisions
- Fairly and accurately allocate energy costs to users
- Identify wasteful practices
- Decrease unnecessary usage
- Produce an energy profile
- Secure the optimum utility rate structure

Catalog Number Selection

IQ 35M Meter

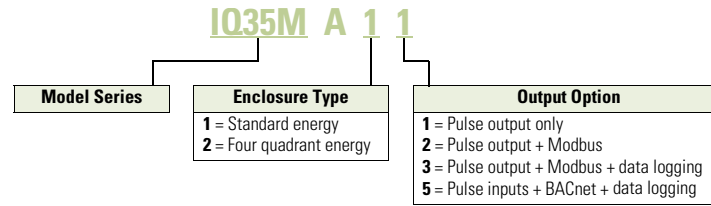

Accessories

IQ 35M Accessories

Description	Catalog Number
IQ35M enclosure, NEMA 4X	IQ35M-ENC
IQ35M fuse pack, single, 1/2A slow-blow	IQ35M-FP1
IQ35M fuse pack, double, 1/2A slow-blow	IQ35M-FP2
IQ35M fuse pack, triple, 1/2A slow-blow	IQ35M-FP3
IQ35M replacement mounting clips	IQ35M-RMC
IQ35M DIN rail	IQ35M-DR
IQ35M DIN rail stop clips (10 pack)	IQ35M-DRSC

IQ 35M Current Transformers

Description	Catalog Number
Solid Core	
IQ35M CT, solid core, 5A:0.33 Vac, 0.30 inch	IQ35M-SO-030-5
IQ35M CT, solid core, 20A:0.33 Vac, 0.30 inch	IQ35M-SO-030-20
IQ35M CT, solid core, 50A:0.33 Vac, 0.50 inch	IQ35M-SO-050-50
IQ35M CT, solid core, 50A:0.33 Vac, 0.75 inch	IQ35M-SO-075-50
IQ35M CT, solid core, 100A:0.33 Vac, 1.25 inch	IQ35M-SO-125-100
IQ35M CT, solid core, 200A:0.33 Vac, 1.25 inch	IQ35M-SO-125-200
IQ35M CT, solid core, 250A:0.33 Vac, 1.25 inch	IQ35M-SO-125-250
IQ35M CT, solid core, 300A:0.33 Vac, 1.25 inch	IQ35M-SO-125-300
IQ35M CT, solid core, 400A:0.33 Vac, 1.25 inch	IQ35M-SO-125-400
Split Core	
IQ35M CT, split core, 5A:0.33 Vac, 0.75 inch	IQ35M-SP-075-5
IQ35M CT, split core, 30A:0.33 Vac, 0.75 inch	IQ35M-SP-075-30
IQ35M CT, split core, 50A:0.33 Vac, 0.75 inch	IQ35M-SP-075-50
IQ35M CT, split core, 100A:0.33 Vac, 0.75 inch	IQ35M-SP-075-100
IQ35M CT, split core, 200A:0.33 Vac, 0.75 inch	IQ35M-SP-075-200
IQ35M CT, split core, 250A:0.33 Vac, 1.25 inch	IQ35M-SP-125-250
IQ35M CT, split core, 300A:0.33 Vac, 1.25 inch	IQ35M-SP-125-300
IQ35M CT, split core, 400A:0.33 Vac, 1.25 inch	IQ35M-SP-125-400
IQ35M CT, split core, 600A:0.33 Vac, 1.25 inch	IQ35M-SP-125-600
IQ35M CT, split core, 800A:0.33 Vac, 2.50 inch	IQ35M-SP-253-800
IQ35M CT, split core, 1000A:0.33 Vac, 2.50 inch	IQ35M-SP-255-1000
IQ35M CT, split core, 1200A:0.33 Vac, 2.50 inch	IQ35M-SP-255-1200
IQ35M CT, split core, 1600A:0.33 Vac, 2.50 inch	IQ35M-SP-255-1600
IQ35M CT, split core, 2000A:0.33 Vac, 2.50 inch	IQ35M-SP-255-2000
IQ35M CT, split core, 2400A:0.33 Vac, 2.50 inch	IQ35M-SP-255-2400

Note: Specifications are subject to change without notice and represent the maximum capabilities of the product with all options installed. This is not a complete feature list. Features and functionality may vary depending on selected options, firmware version and product model. Please refer to User Manual for detailed specifications.

Enclosed Meters



NEMA 12 Single- and Multi-Unit Enclosed Meters

General Description

The Eaton enclosed meter line provides a complete energy metering and data acquisition solution in a single enclosure. Designed for Eaton’s IQ 35M, IQ 150, IQ 250/260, and Power Xpert® 2000/4000/6000/8000 and Multi-Point Meters, Eaton’s enclosed meter line offers mounting and installation flexibility, especially in retrofit applications where no metering compartment or mounting space is available in the existing electrical distribution equipment or where installation time is a premium. Factory designed and wired, Eaton’s enclosed meter line offers savings in labor and installation costs because input current and voltage wiring as well as I/O wiring is prewired to terminal blocks inside the enclosure.

The enclosed meter line has two standard offerings: single-, prewired unit (specific IQ 150, IQ 250/260, PXM 2000, PXM 4000/6000/8000 or PXMP) and a multi-unit (specific IQ 150, IQ 250/260 or IQ 35M models). Because the multi-unit automatically includes Eaton’s Power Xpert Gateway 200E, it facilitates measurement and verification of the energy usage on processes and in buildings. This provides a convenient way to monitor energy usage from multiple points, collect and log specific energy use parameters, and display and generate logs for historical energy usage reports. Simply put, Eaton’s

multi-unit enclosed meter solution helps meet any measurement and verification requirement to show energy efficiency improvements and

results. In addition to the standard offering, Eaton can also provide an enclosed metering solution tailored around your project needs.

Catalog Number Selection

Single Unit Enclosed Meter

PXM2250MA65105 - 2 B

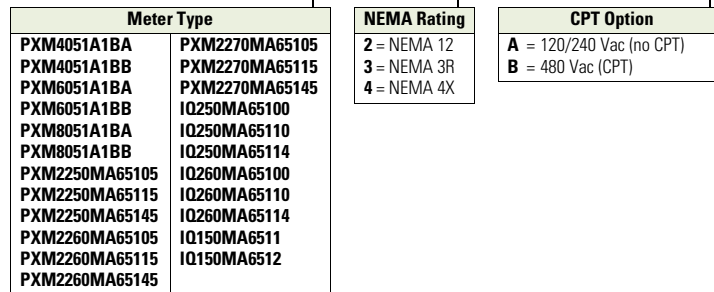

Enclosed PXMP Meter

PXMP - 2 B D

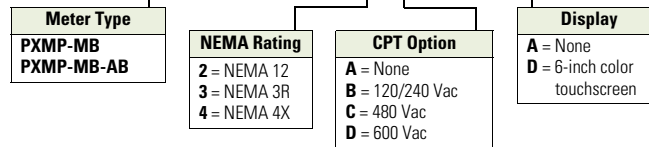

Multi Unit Enclosed Meter

IQ150MA6511 - 2 B 4 C

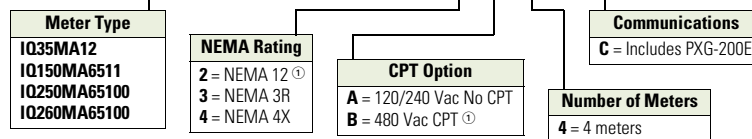

Accessories

Meter Subpanel Assembly

Description	Catalog Number
Meter subpanel assembly for PXM 2000 and IQ 150/250/260 Meters	PXM2K-MSPA-A
Meter subpanel assembly with CPT for PXM 2000 and IQ 150/250/260 Meters	PXM2K-MSPA-B

Notes

- ① Not available with IQ 35M.
- Other meter models available upon request in single- and multi-unit enclosed versions.

IQ Analyzer 6400/6600**IQ Analyzer 6400/6600****General Description**

Eaton's IQ Analyzer 6400/6600 is a complete solution for users who want to monitor all aspects of their electrical distribution system. It provides extensive metering, power quality analysis, remote input monitoring, control relaying, analog input/outputs and communications capability. All programming can be done through the faceplate or through the communications option. Its online Help pushbutton feature displays information on device operation, programming and troubleshooting.

Features and Benefits

- All information is accessible through the communications port
- Quality true rms readings through 50th harmonic
- Meets ANSI C12.16 Class 10 revenue metering specifications
- Accurate readings for non-sinusoidal waveforms with up to 3.0 crest factor
- Screens display auto ranging units, kilo units and mega units as needed
- 10-digit energy readings
- Displays multiple parameters at the same time
- Programmable custom screens

The new IQ Analyzer Model 6600 with waveform display at the device and sub-cycle

voltage disturbance capture provides the capability to monitor a wide range of harmonic parameters. These include harmonic voltage, current magnitudes and phase angles as well as system disturbances such as transient voltage disturbances and sub-cycle voltage interruptions.

Product Selection**IQ Analyzer 6400/6600 Ordering Information**

Description	Catalog Number
IQ Analyzer, separate source power module	IQA6410
IQ Analyzer, 24–48 Vdc power module	IQA6420
IQ Analyzer, three-phase power module	IQA6430
IQ Analyzer, separate source power module with waveform display and sub-cycle voltage distribution capture	IQA6610
IQ Analyzer, 24–48 Vdc power module with waveform display and sub-cycle voltage distribution capture	IQA6620
IQ Analyzer, three-phase power module with waveform display and sub-cycle voltage distribution capture	IQA6630
IQ Flange, to provide extra clearance when mounting	IQFLANGE
45.00-inch (114.3 mm) extension cable for remote mounting of power module	IQA45CABLE
24–48 Vdc separate source power module	IQMDCPM
100–240 Vac and 100–250 Vdc separate source power module	IQMSSPM
Three-phase, self-powered power module	IQM3PPM
INCOM communication module	IPONI
RS-485 communication module with Modbus protocol	MPONI

IQ DP-4000/4100**IQ DP-4000/4100****General Description**

Eaton's IQ DP-4000 is a microprocessor-based meter providing complete electrical metering and system voltage protection. In one compact, standard package the IQ DP-4000 provides an alternative to individually mounted and wired conventional meters and switches. The IQ DP-4000 also monitors apparent power (VA), reactive energy (VAR-hours), apparent energy (VA-hours), and % total harmonic distortion (THD) to provide the user with basic power quality information. The IQ DP-4000 meets and surpasses UL/CSA/CE standards.

Features and Benefits

- Space savings in structure—replaces conventional individual metering devices
- Standardization of design—one door-mounted device
- Direct voltage input up to 600V
- New DIP switch design
- Standardization of CT and PT connections
- With additional PTs and set points the device can be used in HV setting
- Relaying included in I/O module (Model 4100)
- Optional interface capability to computer network for data collection, storage and/or printout via PowerNet—Eaton leading power distribution monitoring network
- Retains present parameters through power failure with non-volatile memory

Product Selection**IQ DP-4000/4100 Ordering Information**

Description	Catalog Number
Separate source without I/O capability	IQDP4010
Separate source control power without I/O, DC supply	IQDP4020
Three-phase without I/O capability	IQDP4030
Separate source with I/O capability	IQDP4110
Separate source control power with three Form C relay output contacts and one sync pulse input, DC supply	IQDP4120
Three-phase with I/O capability	IQDP4130

IQ Energy Sentinels™**IQ Energy Sentinels**

Eaton's IQ Energy Sentinel is a highly accurate, microprocessor-based submeter designed to monitor power and energy readings. It represents an alternative to installing separate wattmeters, watthour meters and watt-demand meters.

Key advantages include unmatched savings in space, lower installation costs, and the capability to communicate data readings in a variety of ways.

IQ Energy Sentinels with built-in CTs and communications have the added benefit of greater overall system accuracy. Conventional metering often is less accurate because external CTs and separate transducers may each have inaccuracies of 1% or more.

The IQ Energy Sentinel provides a unique and cost-effective method to implement energy submetering at lower levels in the distribution system economically.

Submetering application examples for the IQ Energy Sentinel include energy monitoring and demand management, product cost analysis, process/machine tool efficiency and productivity improvement. Additional applications include energy cost allocation of tenant billing for commercial, industrial, recreational and residential facilities.

Retrofitting

The space-saving design characteristics of the breaker mount IQ Energy Sentinels allow them to be added to existing Series C® circuit breakers at any time—often with no additional space or modifications required. Or, they may be installed when upgrading to Series C from older circuit breakers—often with no additional space or modifications required.

The Universal Mount IQ Energy Sentinel with internal CTs may be used wherever breaker mounting is not feasible or possible.

The Universal Mount IQ Energy Sentinel for external CTs may be used for monitoring loads larger than 400A or for when the use of existing CTs is desired.

Product Selection**IQ Energy Sentinels Ordering Information**

Description	Catalog Number
For F-Frame breakers	IQESF __ __ ①
For J-Frame breakers	IQESJ __ __ ①
For K-Frame breakers	IQESK __ __ ①
Universal with internal CTs	IQESUI __ __ ①
Universal for external CTs	IQESUE __ __ ①

Note

① Final three characters of catalog number are for voltage rating, i.e., 2 0 8 for 120/240, 240, 208Y/120 systems.

IQ 230

IQ 230

General Description

Eaton's IQ 230 compact size and flexible mounting capabilities make it perfectly suited for machine control panels such as panelboard and switchboard mains and feeders, low voltage metal-enclosed switchgear feeders, motor control centers, and especially for individual load monitoring. The base module can be display mounted, panel mounted, DIN rail mounted or side mounted. The display fits into a standard 1/4 DIN cutout, and for retrofit applications, a 100 mm ANSI collar is available.

One IQ 230 provides an alternative to an assortment of individually wired and mounted ammeters, voltmeters, ammeter and voltmeter switches, wattmeters, VAR-meters, power factor meters, frequency meters, watthour and demand meters.

ANSI C12 Class 10 revenue metering accuracy makes the IQ 230 an ideal choice for submetering and sub-billing applications.

The IQ 230 can be easily programmed and monitored from the faceplate keypad that features a 4 line x 20 character LED backlit LCD display. Opting for the compatible PowerNet system allows the user to program and monitor the meter remotely from a PC.

Retrofit Opportunities

- Retrofit of existing electrical distribution systems with the IQ 230 for load and energy monitoring
- Five mounting options makes installation easier

Ratings

- Application to 200 kV, no PTs to 600V
- CT ratios selectable 5 to 8000A
- Single-phase two- or three-wire; three-phase three- or four-wire

Product Selection**IQ 230 Ordering Information**

Description	Catalog Number
IQ 230 complete meter with base module, display and 14.00-inch (355.6 mm) cable—with INCOM communications, pulse output, two contact outputs, two digital inputs, one analog input and anti-tamper seal	IQ230
IQ 230M complete meter with base module, display and 14.00-inch (355.6 mm) cable—with RS-485 Modbus communications, pulse output, two contact outputs, two digital inputs, one analog input and anti-tamper seal	IQ230M
3 foot (0.9m) Category 5 cable	IQ23CABLE
6 foot (2.0m) Category 5 cable	IQ26CABLE
10 foot (3.0m) Category 5 cable	IQ210CABLE

MP-3000 Motor Protection



MP-3000 Motor Protection

General Description

Eaton's MP-3000 motor protection relay is a multi-functional microprocessor-based protective relay for the protection of three-phase AC motors. Though it may be applied to any size motor at any voltage level, it is most commonly applied on medium voltage or larger motors. The MP-3000 relay is a current only device that provides complete and reliable motor protection, monitoring and starting control functions.

The MP-3000 motor protection relay is available in either a fixed mount, semi-flush case or in a semi-flush quick release drawout case. Both housings are compact and fit a standard IQ cutout.

The optional quick release drawout case features two-stage contact disconnects and self-shorting CT circuit terminal blocks. A spare self-shorting terminal pair is available for use as relay removal alarm or for continuous motor operation (non-failsafe mode) on relay removal. The optional communication module is externally mounted on the fixed mount case and internally mounted in the drawout case.

The MP-3000 motor protection relay has three phase and one ground current inputs. Both a 5A and 1A version are available. The ground protection and metering functions can be used with either a zero sequence ground CT or from the residual connection of the phase CTs. The zero sequence ground CT provides greater ground fault sensitivity than the residual connection. The unit is user-programmable for 60 Hz or 50 Hz operation.

The MP-3000 motor protection relay provides adaptive overload trip characteristics based on motor temperature when motor RTDs are connected through an optional URTD module. Metering of RTD inputs (individual winding, motor bearing, load and auxiliary temperatures) is also provided.

The MP-3000 motor protection relay has two discrete inputs, four Form C (1NO and 1NC) contacts and one 4 to 20 mA analog output. The relay provides maximum user flexibility to configure the I/O. All inputs and outputs (except for the trip output) are user-programmable. In addition, the relay has 10 LEDs for the indication of protection on, program mode, monitor mode, view setting mode, history mode, log mode, trip, alarm, auxiliary 1 and auxiliary 2 operation. A test page in the program mode provides display indication of the discrete input states and testing of the output relays, target LEDs and analog circuit.

A user-friendly operator interface and display provides quick access to the settings, monitored values, motor history and operational logs. Large LED alphanumeric character display provides easy viewing from any angle in any light. Simple keypad operation provides quick and easy navigation through all settings and stored data. The program mode and emergency override buttons are access restricted via sealing provisions and latched cover. An integrated help function provides an online description display of functions, abbreviations and operations.

Optimum Motor Protection

The MP-3000 motor protection relay has been designed for maximum motor operation and protection. It permits running the motor as close to its design limits while protecting it against excessive heating and damaging overload conditions. The MP-3000 field-proven protection algorithms were developed based on motor designs and operating parameters for optimum operation and protection while minimizing nuisance tripping.

The MP-3000 motor protection relay uses a protection algorithm and measurement technique based on proven positive and negative (unbalance) sequence current sampling and true rms calculations.

Product Selection

MP-3000 Motor Protection Ordering Information

Description	Catalog Number
Motor protection in fixed case, 5A CT, communication capable with PONI	MP-3000
Motor protection in drawout case, 5A CT, no communication	MP-3001
Motor protection in drawout case, 5A CT, with INCOM PONI	MP-3002
Motor protection in fixed case, 1A CT, communication capable with PONI	MP-3100
Motor protection in drawout case, 1A CT, no communication	MP-3101
Motor protection in drawout case, 1A CT, with INCOM PONI	MP-3102
Motor protection drawout case inner chassis, 5A, CT, no communication	MP3001-IC
Motor protection drawout case inner chassis, 5A, CT, with INCOM PONI	MP3002-IC
Motor protection drawout case inner chassis, 1A, CT, no communication	MP-3101-IC
Motor protection drawout case inner chassis, 1A, CT, with INCOM PONI	MP3102-IC
Motor protection drawout case outer chassis	MP3-OC
Motor protection, 5A, URTD, INCOM PONI, fiber optic link	MP3000VPI
Motor protection, 1A, URTD, INCOM PONI, fiber optic link	MP3100VPI
16-foot (5m) fiber optic cable for MP-3000/URTD communication	MPFO-5
Universal RTD module	URTP

FP-5000 Feeder Protection



Feeder Protection FP-5000

General Description

- Microprocessor-based protection with monitoring and control for medium voltage main and feeder applications
- Current, voltage, frequency and power protection for electric power distribution systems
- Complete metering of voltage, currents, power, energy, minimum/maximum and demand functions
- Programmable logic control functions for main-tie-main transfer schemes
- Trip logs, event logs and waveform capture for better fault analysis and system restoration
- Data Logger to provide energy usage profiles for better planning, utilization and energy usage
- Compact, drawout case design
- Meets ANSI, UL and cUL® standards
- Multiple setting groups
- ANSI, IEC and thermal protection curves for greater flexibility

Application Description

Eaton’s FP-5000 feeder protection relay provides complete three-phase and ground overcurrent and voltage protection plus metering in a single, compact drawout case. It may be used as primary protection on feeders, mains and tie circuit breaker applications, and as backup protection for transformers, high voltage lines and differential protection. The relay is most commonly used on medium voltage switchgear applications.

The FP-5000 takes full advantage of its microprocessor technology providing the user new freedoms and a wealth of data-gathering features. The relay performs self-checking of all major hardware and firmware protection elements to ensure their operation in the event of a system or component electrical failure or fault. Protection functions are well suited for main and distribution feeder circuit applications. Programmable logic control functions make the FP-5000 relay ideally suited for main-tie-main and main 1/main 2 transfer schemes.

The multiple settings groups can be used for arc flash mitigation when an alternative setting group, set to have instantaneous elements only is activated using a selector switch and the programmable I/O in the FP-5000.

Features and Benefits

The zone interlocking feature can be used for bus protection instead of an expensive and complicated bus differential (87B) scheme. The FP-5000 works directly with the Eaton Digitrip 3000 and Digitrip MV relays. Breaker failure logic provides faster remote backup clearing times for stuck breaker operation.

The FP-5000 provides trip and close circuit monitoring and alarming features. It continually monitors the complete trip and close circuits for continuity and readiness to trip. Open and close pushbuttons are conveniently located on the front of the relay for local breaker operation.

Loss-of-vacuum monitoring is activated when the breaker is open. Residual current is monitored and alarmed if detected.

When an electrical fault or disturbance occurs, the FP-5000 begins to store the following in non-volatile memory:

- Voltage and current sampled data
- Calculated values
- Status of internal protection functions, logic, contact inputs and outputs

Retrieval and viewing of the data is easy, aiding in the quick analysis and restoration of your electric power system.

When the FP-5000 isn’t responding to disturbances in the power system, it’s providing valuable metering information at the relay and remotely. It provides energy usage and demand reading, and can alarm when usage reaches a set value. Power factor measurements can be used for capacitor bank switching to control cover demand. Inboard data trending can provide load profiles for up to 40 days.

Catalog Number Selection

FP-5000 Feeder Protection

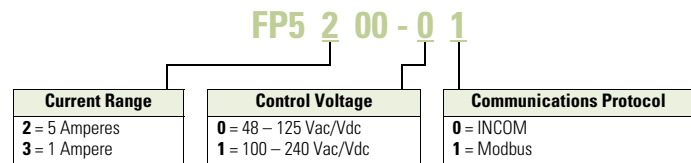

Digitrip 3000 (DT-3000)**DT-3000****General Description**

- Microprocessor-based, three-phase and ground overcurrent relay
- Independent phase and ground measuring circuits and operation
- ANSI, IEC and thermal protection curves
- Fixed mount or drawout design
- Dual-source power supply option for AC control power applications

Eaton's Digitrip 3000 trip unit (DT-3000) is a multifunction, microprocessor-based overcurrent trip unit designed for both ANSI and IEC applications. The DT-3000 design provides true rms sensing design of each phase and ground current.

It can be power from either AC or DC control power. The DT-3000 can be used for any application where instantaneous and/or time overcurrent protection is required.

The DT-3000 may be applied as the transformer primary protection or as backup to the differential protection. The DT-3000 also has zone selective interlocking to minimize equipment damage resulting from a phase or ground fault in an area where long time and/or short time delay is in use.

Product Selection**DT-3000 Ordering Information**

Description	Catalog Number
DT-3000 protective relay	DT3000
DT-3000 protective relay Chicago version	DT3100
DT-3030 protective relay (24–48 Vdc CE Mark version)	DT3030
DT-3000 drawout case protective relay	DT3001
DT-3000 Chicago version drawout case protective relay	DT3101
DT-3030 drawout case protective relay (24–48 Vdc CE Mark version)	DT3031
DT-3000 protective relay with 120 Vac dual-source power supply	DT3010
DT-3000 protective relay with 240 Vac dual-source power supply	DT3020

The integral Dual-Source Power Supply allows the DT-3000 to operate solely from the main CTs during a fault if the normally connected AC voltage is not available, i.e., an electromechanical or electronic “self powered” relay.

Electrical Power System Protection

The DT-3000 provides phase and ground protection for most types of medium voltage electrical power distribution systems.

Protection curves are similar to those on low voltage power circuit breaker trip units, and provide close coordination with downstream devices, as well as upstream fuse and/or electromagnetic relays. Just one DT-3000 replaces the normal complement of three or four conventional electromagnetic overcurrent relays, an ammeter, a demand ammeter, an ammeter switch and, in some situations, a lockout relay switch (device 86).

IQ Flange



IQ Flange

For applications where extra door-mounting space is required, a flange-mounting unit is available. Eaton’s IQ Flange provides an extra 2.50 inches (63.5 mm) of clearance for the device.

Product Selection

IQ Flange

Description	Catalog Number
IQ Flange option, to provide extra clearance when mounting	IQFLANGE

Panel Mounting Adapter Kit for IQ 100/200 Series and PXM 2000 Meters



Panel Mounting Adapter Kit

The flange adapter plate can be installed as follows:

1. Remove the old meter from the panel or door. Many IQ metering products use the typical IQ drilling pattern shown in for mounting.
2. Install the flange adapter plate. Mount it from the rear using the six screws provided in the kit. The flange adapter plate screw hole pattern should match the typical IQ drilling pattern. If not, perform the next step.
3. Drill six holes in the panel or the door to mount the flange adapter plate. Follow the typical IQ drilling pattern. You need only the top, center and bottom sets of holes.
4. Install the new IQ 100/200 Series or PXM 2000 meter in the flange adapter plate. Secure it from behind with four flat washers, lock washers and nuts provided with the meter.

Product Selection

Ordering Information

Description	Catalog Number
Panel mounting adapter kit IQ 100/200 and PXM 2000 Series adapter kit to IQ Analyzer/IQ DP-4000/IQ Data	IQ250-PMAX

IQ DC Power Supply



IQ DC Power Supply

The IQ DC Power Supply is a DC to AC inverter module intended for use where DC power is available, but some AC is required. The unit will operate an MP-3000 or other AC powered IQ devices requiring no more than 75 VA of power at any power factor.

Product Selection

IQ DC Power Supply

Description	Catalog Number
IQ DC power supply	IQDCPS

IQ Cable

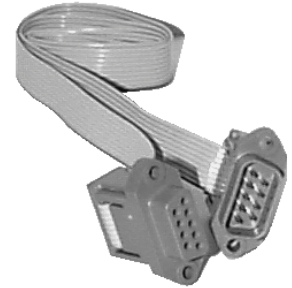

IQ Cable

For applications where remote mounting of the power supply is required, an extension cable is available.

Two types of cable are available. The first (catalog number **IQCABLE**) is for the obsolete IQ Data, Generator, and Data Plus II. The second (catalog number **IQA45CABLE**) is for the IQ Analyzer and IQ DP-4000.

Product Selection

IQ Cable

Description	Catalog Number
36.00-inch (914.4 mm) extension cable IQ Data, Generator, Data Plus II	IQCABLE
45.00-inch (1143.0 mm) extension cable IQ Analyzer/IQ DP-4000	IQA45CABLE

IQ Floor-Mounted Enclosure



Two 10-Inch Wide Enclosures (Shown with Optional 10-Inch High Bus Compartment)

Type 1

Standard AMPGARD structure construction, painted ASA-61. To be used as a lineup extension for mounting IQ products. Each 10.00-inch (254.0 mm) wide section comes with (two) doors with “works-in-a-drawer” drawout panel. Each door has three standard IQ cutouts with device panels, and can be supplied with or without IQ devices.

Product Selection

IQ Floor-Mounted Enclosure

Description	Style Number
10.00-inch W x 30.00-inch D x 90.00-inch H (254.0 mm W x 762.0 mm D x 2286.0 mm H) Bus compartment optional	2147A95G35

Addressable Relay II



Addressable Relay II

The Addressable Relay II has two status inputs and a Form C contact output.

- Input rating: 48–120 Vac, 48–125 Vdc
- Output contact rating: 10A at 277 Vac, 10A at 30 Vdc

Features include a communications watchdog and relay pulse. Baud rate is selectable.

Product Selection

Addressable Relay II

Description	Catalog Number
Addressable Relay II	ARII

Power Modules

Eaton and Westinghouse have produced a number of different meters dating back to the 1980s. Many of these meters used and continue to use power modules to provide voltage sensing isolation and control power to the meter.

Power modules are available to power the meter directly from the voltage source being sensed or for separate control power input. Renewal part power modules are available for the meters shown in the table below.

Product Selection

Power Modules

Description	Used with Meter Style Number	Power Module Catalog Number
Old IQ DP-4000 and IQ Analyzer self-powered three-phase power module	2D82302GXX ①	IQA3PPM
	4D13110GXX ①	
Old IQ DP-4000 and IQ Analyzer separate source 110 to 240 Vac or 110 to 250 Vdc power module	2D82302GXX ①	IQASSPM
	4D13110GXX ①	
New IQ DP-4000 and IQ Analyzer self-powered three-phase power module	66D2045GXX ①	IQM3PPM
	66D2040GXX ①	
New IQ DP-4000 and IQ Analyzer 24/48 Vdc power module	66D2045GXX ①	IQMDCPM
	66D2040GXX ①	
New IQ DP-4000 and IQ Analyzer separate source 110 to 240 Vac or 110 to 250 Vdc power module	66D2045GXX ①	IQMSSPM
	66D2040GXX ①	

Note

- ① The adjacent power modules will work with each basic meter style, regardless of the last two digits of the meter style number.

Current Transformers (CTs)



Current Transformers (CTs)

General Description

Eaton's low voltage current transformers are available in both solid core and split core designs. Engineered for electronic metering applications, all solid core designs and selected split core designs offer ANSI metering quality accuracy. The solid core designs also meet ANSI C57.13 relay accuracy requirements including over-ranging capabilities. The current transformer offering has a 5 ampere secondary at the rated primary current.

Split core CTs are specifically designed to be installed around primary conductors without disconnecting wires or breaking the circuit to be monitored. These current transformers are perfect solutions for energy management applications and are manufactured for installation ease.

Product Selection

Solid Core ANSI Metering Accuracy

Primary Current Rating	ANSI B0.1 Metering Class at 60 Hz (Accuracy in %)	Window Size in Inches (mm) Diameter	Catalog Number	Mounting Bracket Catalog Number
1.25 (31.8) Window				
50	1.2	1.25 (31.8)	S060-500	①
100	0.6	1.25 (31.8)	S060-101	①
150	0.3	1.25 (31.8)	S060-151	①
200	0.3	1.25 (31.8)	S060-201	①
1.56 (39.6) Window				
300	0.3	1.56 (39.6)	S050-301	S050BRAC
400	0.3	1.56 (39.6)	S050-401	S050BRAC
500	0.3	1.56 (39.6)	S050-501	S050BRAC
600	0.3	1.56 (39.6)	S050-601	S050BRAC
750	0.3	1.56 (39.6)	S050-751	S050BRAC
800	0.3	1.56 (39.6)	S050-801	S050BRAC
1000	0.3	1.56 (39.6)	S050-102	S050BRAC
1200	0.3	1.56 (39.6)	S050-122	S050BRAC
3.25 (82.6) Window				
400	0.3	3.25 (82.6)	S080-401	S080BRAC
500	0.3	3.25 (82.6)	S080-501	S080BRAC
600	0.3	3.25 (82.6)	S080-601	S080BRAC
750	0.3	3.25 (82.6)	S080-751	S080BRAC
800	0.3	3.25 (82.6)	S080-801	S080BRAC
1000	0.3	3.25 (82.6)	S080-102	S080BRAC
1200	0.3	3.25 (82.6)	S080-122	S080BRAC
4.25 (108.0) Window				
500	0.3	4.25 (108.0)	S090-501	S090BRAC
600	0.3	4.25 (108.0)	S090-601	S090BRAC
750	0.3	4.25 (108.0)	S090-751	S090BRAC
800	0.3	4.25 (108.0)	S090-801	S090BRAC
1000	0.3	4.25 (108.0)	S090-102	S090BRAC
1200	0.3	4.25 (108.0)	S090-122	S090BRAC
1500	0.3	4.25 (108.0)	S090-152	S090BRAC
1600	0.3	4.25 (108.0)	S090-162	S090BRAC
2000	0.3	4.25 (108.0)	S090-202	S090BRAC
2500	0.3	4.25 (108.0)	S090-252	S090BRAC
3000	0.3	4.25 (108.0)	S090-302	S090BRAC
6.31 (160.3) Window				
600	0.3	6.31 (160.3)	S025-601	S025BRAC
750	0.3	6.31 (160.3)	S025-751	S025BRAC
800	0.3	6.31 (160.3)	S025-801	S025BRAC
1000	0.3	6.31 (160.3)	S025-102	S025BRAC
1200	0.3	6.31 (160.3)	S025-122	S025BRAC
1500	0.3	6.31 (160.3)	S025-152	S025BRAC
1600	0.3	6.31 (160.3)	S025-162	S025BRAC
2000	0.3	6.31 (160.3)	S025-202	S025BRAC
2500	0.3	6.31 (160.3)	S025-252	S025BRAC
3000	0.3	6.31 (160.3)	S025-302	S025BRAC
3500	0.3	6.31 (160.3)	S025-352	S025BRAC
4000	0.3	6.31 (160.3)	S025-402	S025BRAC

Note

① Contact Eaton for further information.

Split Core ANSI Metering Accuracy

Primary Current Rating	ANSI B0.1 Metering Class at 60 Hz (Accuracy in %)	Window Size in Inches (mm)	Catalog Number
2.00 x 5.50 (50.8 x 139.7)			
400	2.4	2.00 x 5.50 (50.8 x 139.7)	M000-401
500	2.4	2.00 x 5.50 (50.8 x 139.7)	M000-501
600	2.4	2.00 x 5.50 (50.8 x 139.7)	M000-601
800	1.2	2.00 x 5.50 (50.8 x 139.7)	M000-801
1000	1.2	2.00 x 5.50 (50.8 x 139.7)	M000-102
1200	0.6	2.00 x 5.50 (50.8 x 139.7)	M000-122
1500	0.6	2.00 x 5.50 (50.8 x 139.7)	M000-152
1600	0.6	2.00 x 5.50 (50.8 x 139.7)	M000-162
2000	0.6	2.00 x 5.50 (50.8 x 139.7)	M000-202
4.10 x 7.10 (104.1 x 180.3)			
600	4.8	4.10 x 7.10 (104.1 x 180.3)	M050-601
750	4.8	4.10 x 7.10 (104.1 x 180.3)	M050-751
800	2.4	4.10 x 7.10 (104.1 x 180.3)	M050-801
1000	2.4	4.10 x 7.10 (104.1 x 180.3)	M050-102
1200	1.2	4.10 x 7.10 (104.1 x 180.3)	M050-122
1500	1.2	4.10 x 7.10 (104.1 x 180.3)	M050-152
2000	0.6	4.10 x 7.10 (104.1 x 180.3)	M050-202
2500	0.6	4.10 x 7.10 (104.1 x 180.3)	M050-252
3000	0.6	4.10 x 7.10 (104.1 x 180.3)	M050-302
3500	0.6	4.10 x 7.10 (104.1 x 180.3)	M050-352
4000	0.3	4.10 x 7.10 (104.1 x 180.3)	M050-402

Split Core Current Transformers

Primary Current Rating	Accuracy at 60 Hz (in %)	Window Size in Inches (mm)	Catalog Number
0.80 x 1.95 (20.3 x 49.5)			
100	5.0	0.80 x 1.95 (20.3 x 49.5)	M030-101
150	5.0	0.80 x 1.95 (20.3 x 49.5)	M030-151
200	4.0	0.80 x 1.95 (20.3 x 49.5)	M030-201
300	2.0	0.80 x 1.95 (20.3 x 49.5)	M030-301
400	2.0	0.80 x 1.95 (20.3 x 49.5)	M030-401
1.42 x 1.53 (36.1 x 38.9)			
100	5.0	1.42 x 1.53 (36.1 x 38.9)	M040-101
150	4.0	1.42 x 1.53 (36.1 x 38.9)	M040-151
200	1.5	1.42 x 1.53 (36.1 x 38.9)	M040-201
300	1.5	1.42 x 1.53 (36.1 x 38.9)	M040-301
400	1.5	1.42 x 1.53 (36.1 x 38.9)	M040-401
2.60 x 2.75 (66.0 x 69.9)			
200	1.0	2.60 x 2.75 (66.0 x 69.9)	M060-201
300	1.0	2.60 x 2.75 (66.0 x 69.9)	M060-301
400	1.0	2.60 x 2.75 (66.0 x 69.9)	M060-401
500	1.0	2.60 x 2.75 (66.0 x 69.9)	M060-501
600	1.0	2.60 x 2.75 (66.0 x 69.9)	M060-601
750	1.0	2.60 x 2.75 (66.0 x 69.9)	M060-751
800	1.0	2.60 x 2.75 (66.0 x 69.9)	M060-801
1000	1.0	2.60 x 2.75 (66.0 x 69.9)	M060-102
1200	1.0	2.60 x 2.75 (66.0 x 69.9)	M060-122
2.60 x 6.25 (66.0 x 158.8)			
500	1.0	2.60 x 6.25 (66.0 x 158.8)	M080-501
600	1.0	2.60 x 6.25 (66.0 x 158.8)	M080-601
800	1.0	2.60 x 6.25 (66.0 x 158.8)	M080-801
1000	1.0	2.60 x 6.25 (66.0 x 158.8)	M080-102
1200	1.0	2.60 x 6.25 (66.0 x 158.8)	M080-122
1500	1.0	2.60 x 6.25 (66.0 x 158.8)	M080-152
1600	1.0	2.60 x 6.25 (66.0 x 158.8)	M080-162
2000	1.0	2.60 x 6.25 (66.0 x 158.8)	M080-202
2500	1.0	2.60 x 6.25 (66.0 x 158.8)	M080-252
3000	1.0	2.60 x 6.25 (66.0 x 158.8)	M080-302

Clamp-On Current Transformers



IQ Accessories—Clamp-On CTs

General Description

Eaton's optional Clamp-on Current Transformers (CTs) are designed to be used in cases where there are no existing CTs or the existing CTs cannot be accessed, these clamp-on CTs can be used.

These clamp-on CTs are packaged individually. Most applications will require at least three clamp-on CTs, one for each phase.

Product Selection

Ordering Information

Description	Catalog Number
150–300–600A	IQAPORT0600CT
500–1000–1500A	IQAPORT1500CT

Shaded area denotes obsolete or discontinued products and services.

IQ 2000



IQ 2000 Model A



IQ 2000 Model B

Recommended Replacement

Production of IQ 2000 devices has been discontinued. The IQ 2000 can be replaced with the MP-3000 electronic motor protective relay and the IQ DP-4000 electronic meter. The MP-3000 provides motor current protective relaying, while the IQ DP-4000 provides complete electrical metering and voltage protective alarming functions. For specific application consideration, contact your local Eaton Field Sales office.

IQ Analyzer 6000/6200



IQ Analyzer 6000/6200

Eaton’s Cutler-Hammer IQ Analyzer 6000/6200 is a complete solution for users who want to monitor all aspects of their electrical distribution system. It provides extensive metering, power quality analysis, remote input monitoring, control relaying, analog input/outputs and communications capability. All programming can be done through the faceplate or through the communications option. Its online Help Pushbutton feature displays information on device operation, programming and troubleshooting.

Features and Benefits

- All information accessible through communications port
- Quality true rms readings through 50th harmonic
- Meets ANSI C12.16 Class 10 revenue metering spec
- Accurate readings for non-sinusoidal waveforms with up to 3.0 crest factor
- Screens display auto ranging units, kilo units, mega units as needed
- 10-digit energy readings
- Displays multiple parameters at the same time
- Programmable custom screens. The IQ Analyzer Model 6200 with waveform display at the device and sub-cycle voltage disturbance capture provides the capability to monitor a wide range of harmonic parameters. These include harmonic voltage, current magnitudes and phase angles, as well as system disturbances such as transient voltage disturbances and sub-cycle voltage interruptions. This unit is also available in a portable version.

Recommended Replacement

Eaton’s IQ Analyzer 6400/6600

RTD Modules



Universal RTD Module

Recommended Replacement

The RTD Modules for the IQ 2000 have been discontinued. Now available is the new Universal RTD Module that replaces all of the RTD modules for the Model A and B IQ 2000 units, as well as the IQ 1000, IQ 1000 II and all current IQ metering and protection products.

Product Selection

Universal RTD

Description	Catalog Number
Universal module	URTD

Shaded area denotes obsolete or discontinued products and services.

IQ Data Plus and IQ Data Plus II



IQ Data Plus II

Eaton’s Cutler-Hammer IQ Data Plus was discontinued in 1989 and was replaced by the IQ Data Plus II. The IQ Data Plus II was discontinued in 1998.

Recommended Replacement

IQ DP-4000

IQ 1000 and IQ 1000 II



IQ 1000 II

Recommended Replacement

Both the IQ 1000 and the IQ 1000 II have been discontinued and replaced by the MP-3000 for complete motor protection. A detailed application note (MP3K01R4.PDF) describing replacement of the IQ 1000 II with an MP-3000 is available at www.eaton.com.

IQ Data



IQ Data

Eaton’s Cutler-Hammer IQ Data provides simultaneous current and voltage metering. In one compact, standard package, this device provides an alternative to individually mounted and wired ammeters, voltmeters, and ammeter and voltmeter switches.

Features and Benefits

- Space savings in structure—replaces ammeter, voltmeter, selector switches and frequency meter (IQ Generator)
- Standardization of design—one door-mounted device
- Direct voltage input up to 600V—no additional potential transformers (PTs) required
- User-friendly—field-settable DIP switches
- Standard model derives power from separate source 120/240 Vac supply
- Only two style numbers
- No need to stock multiple units for different current transformers (CT) and PT ratios
- Interface capability to computer network for data collection, storage and/or printout via IMPACC
- Membrane faceplate, designed and tested to perform in a harsh industrial environment (Type 3R, 12)

- Retains preset parameters through power failure with use of field-settable DIP switches (no batteries)

Product Selection

IQ Data

Description	Catalog Number
Basic metering	IQDATA
Basic metering with three-phase power module	IQDATAPM

Recommended Replacement

IQ DP-4000

Shaded area denotes obsolete or discontinued products and services.

IQ Generator



IQ Generator

Eaton’s Cutler-Hammer IQ Generator provides simultaneous current and voltage metering. In addition, the IQ Generator monitors frequency. This device provides an alternative to individually mounted and wired ammeters, voltmeters, ammeter and voltmeter switches, and frequency meters.

Features and Benefits

- Space savings in structure—replaces ammeter, voltmeter, selector switches and frequency meter (IQ Generator)
- Standardization of design—one door-mounted device
- Direct voltage input up to 600V—no additional PTs required
- User-friendly—field-settable DIP switches
- Standard model derives power from separate source 120/240 Vac supply
- Only two style numbers
- No need to stock multiple units for different CT and PT ratios
- Interface capability to computer network for data collection, storage and/or printout via IMPACC
- Membrane faceplate, designed and tested to perform in harsh industrial environment (Type 3R, 12)
- Retains preset parameters through power failure with use of field-settable DIP switches (no batteries)

Product Selection

IQ Generator

Description	Catalog Number
Basic metering	IQGEN
Basic metering with three-phase power module	IQGENPM

Recommended Replacement

IQ DP-4000

IQ 300



IQ 300

Eaton’s Cutler-Hammer IQ 300’s thin display and flexible mounting capabilities make it perfectly suited for any application where an accurate, multifunction meter is desired, such as panelboard and switchboard mains and feeders, motor control centers, and both low voltage and high voltage metal-enclosed switchgear.

Features and Benefits

- Bright display with eight large numeric digits along with a 10-character description of the measured value makes the IQ 300 ideal for switchgear mounting
- Base unit can be display mounted for simple, one-hole installation
- Base unit can be mounted up to 10 feet (3m) away from display and has three mounting options

Product Selection

IQ 300

Description	Catalog Number
IQ 310 complete meter with base module, display and 14.00-inch (355.6 mm) cable—no communications, no pulse output	IQ310
IQ 320 complete meter with base module, display and 14.00-inch (355.6 mm) cable—with INCOM communications and pulse output	IQ320
IQ 330 complete meter with base module, display and 14.00-inch (355.6 mm) cable—with INCOM communications, pulse output, two contact outputs, two digital inputs, one analog input and anti-tamper seal	IQ330
IQ 330M complete meter with base module, display and 14.00-inch (355.6 mm) cable—with RS-485 Modbus communications, pulse output, two contact outputs, two digital inputs, one analog input and anti-tamper seal	IQ330M
IQ 300D display module only	IQ300D

Recommended Replacement

IQ DP-4000/4100

Shaded area denotes obsolete or discontinued products and services.

IQ 210/220



IQ 210/220

General Description

Eaton’s IQ 210/220 compact size and flexible mounting capabilities make it perfectly suited for machine control panels such as panelboard and switchboard mains and feeders, low voltage metal-enclosed switchgear feeders, motor control centers, and especially for individual load monitoring. The base module can be display mounted, panel mounted, DIN rail mounted or side mounted. The display fits into a standard 1/4 DIN cutout, and for retrofit applications, a 100 mm ANSI collar is available.

One IQ 210/220 provides an alternative to an assortment of individually wired and mounted ammeters, voltmeters, ammeter and voltmeter switches, wattmeters, VAR-meters, power factor meters, frequency meters, watthour and demand meters.

ANSI C12 Class 10 revenue metering accuracy makes the IQ 200 an ideal choice for submetering and sub-billing applications.

The IQ 200 can be easily programmed and monitored from the faceplate keypad that features a 4 line x 20 character LED backlit LCD display. Opting for the compatible PowerNet system allows the user to program and monitor the meter remotely from a PC.

Retrofit Opportunities

- Retrofit of existing electrical distribution systems with the IQ 210/220 for load and energy monitoring
- Five mounting options makes installation easier

Ratings

- Application to 200 kV, no PTs to 600V
- CT ratios selectable 5 to 8000A
- Single-phase two- or three-wire; three-phase three- or four-wire

Product Selection

IQ 210/220 Ordering Information

Description	Catalog Number
IQ 210 complete meter — includes base, display and 14.00-inch (355.6 mm) cable	IQ210
IQ 220 complete meter — includes base display module and 14.00-inch (355.6 mm) cable with INCOM communications and KYZ output	IQ220
IQ 220 transducer base only with INCOM communications and KYZ output	IQ220TRAN
IQ 200D IQ 210/220 display module	IQ200D
3 foot (0.9m) Category 5 cable	IQ23CABLE
6 foot (2.0m) Category 5 cable	IQ26CABLE
10 foot (3.0m) Category 5 cable	IQ210CABLE

Recommended Replacement

IQ 230

Shaded area denotes obsolete or discontinued products and services.

IQ 110/115 Electronic Power Meters



IQ 110 Electronic Power Meter

General Description

The IQ 100 Meter family provides capabilities you would not normally expect in affordable, compact meters, such as fast sampling rate and accurate metering for a full range of power attributes. Providing the first line of defense against costly power problems, Eaton's IQ 100 series electronic power meters can perform the work of an entire wall of legacy metering equipment utilizing today's technology.

When space is at a premium, yet you need ANSI C12.20 accuracy, the IQ 100 series fit the bill. These meters are ideal for electrical equipment assemblies, machine control panels, such as panelboard and switchboard mains and feeders, low voltage metal-enclosed switchgear feeders and motor control centers. Requiring far less space than other meters with similar functionality, IQ 100 series fit into a standard ANSI or IEC cutout on a panelboard or other electrical equipment, and therefore fit easily into retrofit applications.

Features and Benefits

- Measure and display real-time information about critical power parameters with a sampling rate of 400 samples per cycle
- Monitor power utilization and quality with ANSI C12.20 accuracy (0.5%)
- Verify meter accuracy with KYZ test pulse self-certification capabilities
- Optional Modbus RTU communications
- Available as transducer only or with display
- Designed to accommodate upgrades
- Integrate into Eaton's Power Xpert Architecture for a holistic system-level view

Product Selection

IQ 110/115 Ordering Information

Description	Catalog Number
Measures voltage and current	IQ 110
Measures voltage, current and frequency	IQ 115

Recommended Replacement

IQ 130/140

Shaded area denotes obsolete or discontinued products and services.

IQ Power Sentinel



IQ Power Sentinel

General Description

Like the IQ Energy Sentinel, the IQ Power Sentinel is a highly accurate microprocessor-based submeter designed to monitor power and energy. In addition to watts, watthour and watt-demand, the IQ power sentinel monitors current, voltage, reactive power (VARs), apparent power (VA), power factor and frequency. The IQ Power Sentinel offers an accurate and economic alternative to separate meters and transducers.

The IQ Power Sentinel is only available in the universal mount with internal CTs up to 400 amperes.

Features and Benefits

Features

- Monitors (accuracy stated full scale)
 - AC line current (each phase) $\pm 0.5\%$
 - AC line-to-line voltage $\pm 0.5\%$
 - AC line-to-neutral voltages $\pm 0.5\%$
 - Watts (each phase and total) $\pm 1.0\%$
 - VARs (each phase and total) $\pm 1.0\%$
 - VA (each phase and total) $\pm 1.0\%$
 - Apparent Power Factor (each phase and total) $\pm 0.5\%$
 - Displacement Power Factor (each phase and total) $\pm 0.5\%$
 - Demand (total watts) $\pm 1.0\%$
 - Frequency $\pm 0.5\%$
 - Watthours $\pm 1.0\%$

- Built-in CTs version up to 400 amperes
- Panel or DIN rail mounted
- Powered directly off the line
- Built-in communication capability
 - Address set by DIP switches
 - Communication at 9600 baud
 - Noise immune INCOM protocol
- Choice of operator interfaces
 - Subnetwork Master Local Display
 - Breaker Interface Module
 - Power Management Energy Billing software
 - Power Management Software
- UL and CSA listed
- CE mark

Benefits

- One device replaces multiple meters and/or transducers
- Improved system accuracy
- Savings in product cost
- Savings in space
- Savings in installation cost
- No external power source is needed
- Permits remote monitoring and interconnection with programmable logic controllers and building management systems. For further information see section on Power Management Software Systems
- Designed to interface directly with Power Management Software Energy Billing software
- Flexibility—displays what is needed where it is needed
- Power Management Software

Product Selection

IQ Power Sentinel Ordering Information

Description	Catalog Number
Universal with internal CTs, 120/240, 240, 208Y/120	IQPSUI208
Universal with internal CTs, 220/380, 230/400, 240/415	IQPSUI400
Universal with internal CTs, 480, 480Y/277	IQPSUI480
Universal with internal CTs, 600, 600Y/347	IQPSUI600

Recommended Replacement

PM3

Shaded area denotes obsolete or discontinued products and services.

IQ Multipoint Energy Submeter II



IQ Multipoint Energy Submeter II

General Description

Eaton's IQ Multipoint Energy Submeter II is a revenue class electronic submetering device that can be mounted in panelboards or switchboards. When mounted in a panelboard or switchboard, the IQ Multipoint Energy Submeter II provides customers with an integrated power distribution and energy metering solution that saves space, reduces installation labor and lowers total cost.

Features and Benefits

The IQ Multipoint Energy Submeter II offers low-cost metering of kW and kWh for multiple tenants of residential and commercial office buildings for one- to three-phase voltage loads not exceeding 347/600 volts. The IQ Multipoint Energy Submeter II contains INCOM networking to chain together multiple meters in locations throughout the facility. See above for a typical apartment building layout.

- Multipoint electrical energy metering
- Built-in communication interface

- Flexible metering configuration
- Monitors single-phase and three-phase loads from 120 Vac to 600 Vac in three voltage ranges
- Monitors power in watts and energy in watthours for up to 16 Current Sensors
- Very low profile design, less than 1.50 inches (38.1 mm) in height
- Energy values stored in non-volatile memory
- Stores extensive energy profile data for each metering point. Can be used to identify coincidental peak demand contribution
- Space-saving stacking design allows two units to be mounted together
- Supports Time-of-Use energy monitoring
- Demand interval adjustable from 5 to 60 minutes
- Measures bus voltage
- Front panel LEDs provide status of unit and communication activity
- Meets rigid ANSI C12.1 and IEC 61036 accuracy specifications for revenue meters
- Can be directly mounted in a UL-approved panelboard or switchboard

Product Selection

IQ Multipoint Energy Submeter II Ordering Information

Description	Catalog Number
IQ Multipoint Energy Submeter II 120V with INCOM	IQMESIIN1
IQ Multipoint Energy Submeter II 277V with INCOM	IQMESIIN2
IQ Multipoint Energy Submeter II 347V with INCOM	IQMESIIN3
Current Sensors—5 amperes, Qty. 3	CS005 ①
Current Sensors—50 amperes, Qty. 6	CS050
Current Sensors—70 amperes, Qty. 6	CS070
Current Sensors—125 amperes, Qty. 3	CS125
Current Sensors—200 amperes, Qty. 3	CS200
Current Sensors—400 amperes, Qty. 3	CS400
Current Sensor Extensions—4 feet (1.2m), Qty. 6	CSET04
Current Sensor Extensions—8 feet (2.4m), Qty. 3	CSET08
Current Sensor Extensions—16 feet (4.9m), Qty. 3	CSET16

① CS005 is not discontinued and is still being used.

Recommended Replacement

Power Xpert Multi-Point Meter

Replacement Capabilities—Discontinued Product—Recommended Replacement

Further Information

Publication Number	Description
Metering Devices	
TD02600001E	Selection Chart
TD02601007E	Power Xpert 4000/6000/8000
TD02601017E	Power Xpert 2000
TD150006EN	Power Xpert Multi-Point Meter
TD02601016E	IQ 250/260
TD02601015E	IQ 130/140/150
TD02601019E	IQ 150S/250S
TD02601018E	IQ 35M
TD.17.02B.T.E	IQ Analyzer
TD.17.03A.T.E	IQ DP-4000
TD.17.31.T.E	IQ 300
TD.17.06A.T.E	IQ 200
TD02601003E	IQ 110/115
TD.17.07.T.E	IQ Sentinels
TD17C02TE	IQ Multipoint Energy Submeter II
TD17C01TE	Portable IQ Analyzer
TD17C03TE	Optional Clamp-on CTs
TD.17.08A.T.E	IQ DP-4000 I/O Module
TD.17.08A.T.E	IQ Analyzer/IQ DP-4000 Auxiliary Power Supply
TD02601002E	Current Transformers
Protective Relays	
TD02600001E	Selection Chart
TD.17.10.T.E	Digitrip 3000 Overcurrent Relay
TD.17.11.T.E	MP-3000 Motor Protection Relay
TD.17.30.T.E	FP-5000 Feeder Relay
TD.17.12.T.E	Dual-Source Power Supply
TD.17.13.T.E	Digitrip 3000 Optional Drawout Case
TD.17.14.T.E	Universal RTD Module
TD.17.08A.T.E	IQ DC Power Supply

Pricing Information**IQ/PXM Products**

Vista/VISTALINE™ Discount
Symbol C10-S24.

DT-3000

Vista/VISTALINE Discount
Symbol MV-3.