

# Magnum low-voltage power circuit breakers (ANSI and IEC) renewal parts and accessories



## Contents

### Description

### Page

Procedure for identifying breaker frame.....	2
Ordering instructions .....	2
Non-warranty repair .....	2
Magnum breaker catalog identification.....	2
Breaker mechanism and related parts .....	5
Current path components .....	7
Electrical accessories.....	11
Secondary wiring, repair, and replacement .....	12
Cassette (cell) attachments .....	15
External accessories .....	18
Mechanical interlock configurations.....	19
Mechanical interlock accessories .....	20
Standard breaker replacement parts .....	21
PXR trip units and related components .....	24
Digitrip trip units and related components .....	25

**Note:** Items in this renewal parts data book are designed for field installation by qualified personnel. Contact Eaton if assistance for field installation is required, or for information about any parts not referenced or identified.



*Powering Business Worldwide*

### Procedure for identifying breaker frame



Magnum PXR nameplate (typical for Power Defense™ SB)

The Catalog Number is a 25-character string located on the breaker's nameplate, not including spaces.

An example of this number is:

- MPS8203WEA202AATAAWKPALAX

Eaton's Magnum™ circuit breakers can be identified using either the Catalog Number or the General Order Number (G.O. #), Item Number, and Sequence Number that are located on the breaker's nameplate.

An example of what will be seen on the nameplate is:

- G.O. #1234567 It: 001, Seq 002

### Ordering instructions

1. Check the nameplate to identify the type of breaker you have. (If adding accessories or options to existing breakers, you must also provide the information for those accessories.)
2. Identify the part(s) from the photos shown.
3. Determine the style or catalog number for the required parts.
4. Specify the quantity required.
5. Order the parts from your local Eaton distributor (visit [www.eaton.com/howtobuy](http://www.eaton.com/howtobuy)).
6. State the method of shipment.

**IMPORTANT**

**EATON'S ENGINEERING SERVICES & SYSTEMS (EESS) OFFERS PARTS INSTALLATION AND AUTHORIZED REPAIR. CALL 1-800-498-2678 FOR THE EESS DISTRICT OPERATING CENTER NEAREST YOU.**

### Non-warranty repair

Eaton offers non-warranty factory repair service for Magnum breakers. A non-warranty breaker is one that has exceeded its original factory warranty.

The non-warranty repair service features:

- Quality Magnum breaker repair specified and audited by factory engineers according to procedures
- Only genuine new Eaton replacement parts
- Original factory specifications and design drawings used by factory trained technicians
- One-year factory warranty issued from date of shipment from repair center

### Magnum breaker catalog identification

For Magnum PXR and Power Defense SB (PD-SB) breaker catalog number identification, please visit [www.eaton.com/magnumpxr](http://www.eaton.com/magnumpxr) or [www.eaton.com/powerdefensesb](http://www.eaton.com/powerdefensesb) and view the technical product guide, or search "PA013006EN" on [www.eaton.com](http://www.eaton.com). For Magnum DS/SB/IEC breaker catalog number identification, please visit [www.eaton.com/magnum](http://www.eaton.com/magnum) and view the technical product guide, or search "CA013002EN" on [www.eaton.com](http://www.eaton.com).

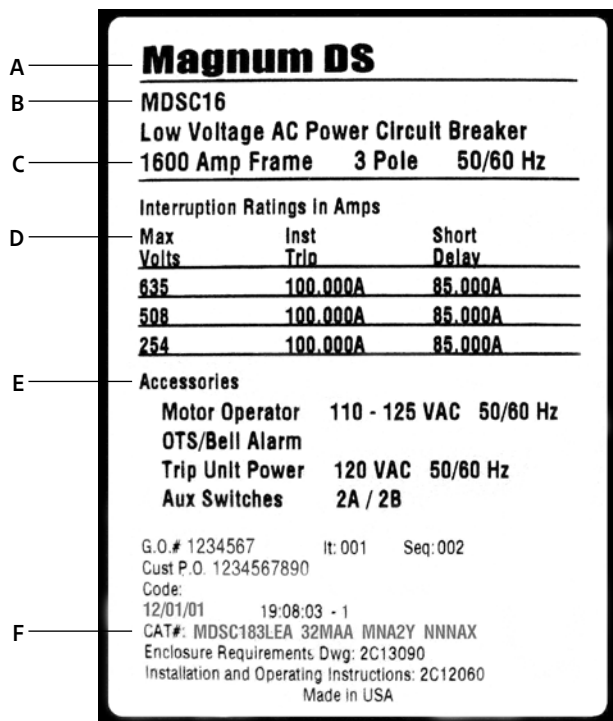

Magnum DS nameplate (typical for Magnum DS/SB/IEC)

- A Low-voltage air circuit breaker family name
- B Breaker family designation number
- C Breaker frame size in amperes
- D Interrupting capacity rating
- E Accessories (factory installed)
- F Catalog number

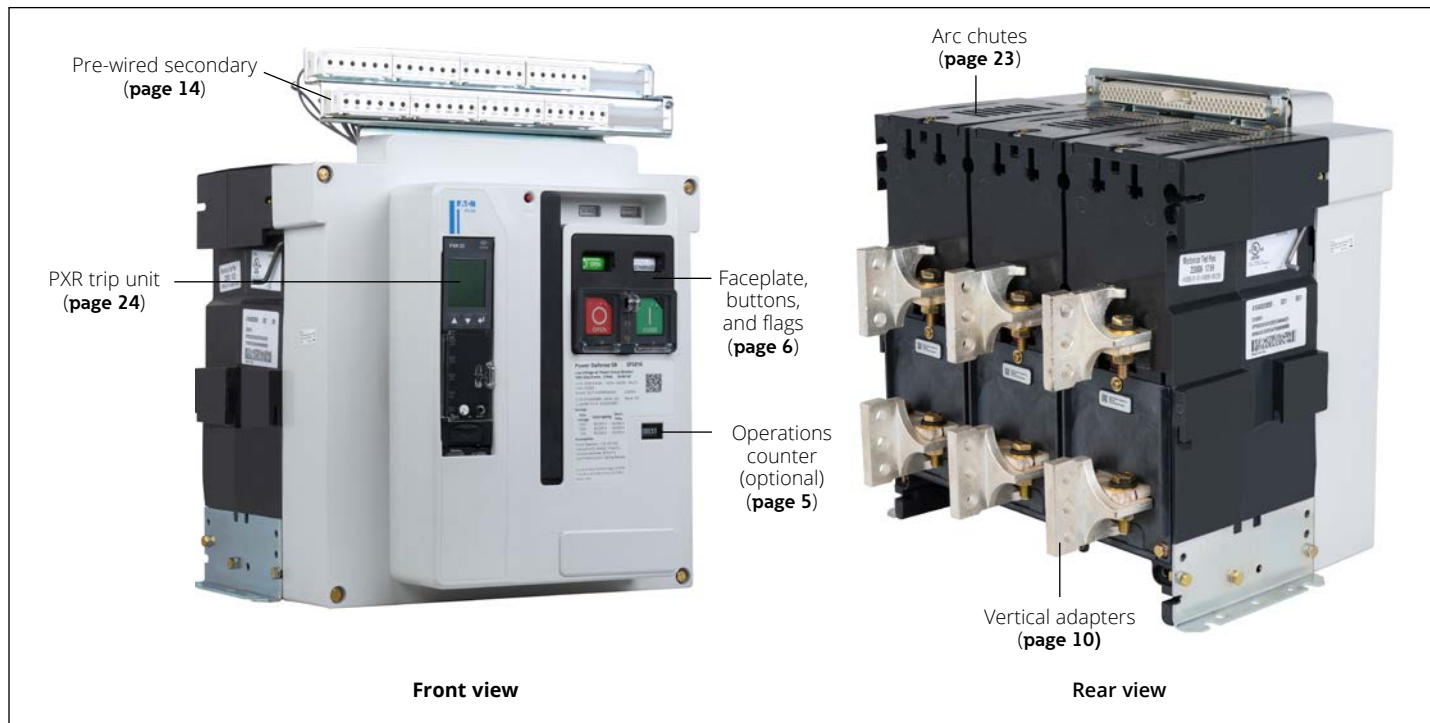

Figure 1. Magnum fixed-mounted breaker (800–3200 A), standard frame shown; narrow frame (800–2000 A) available, not shown

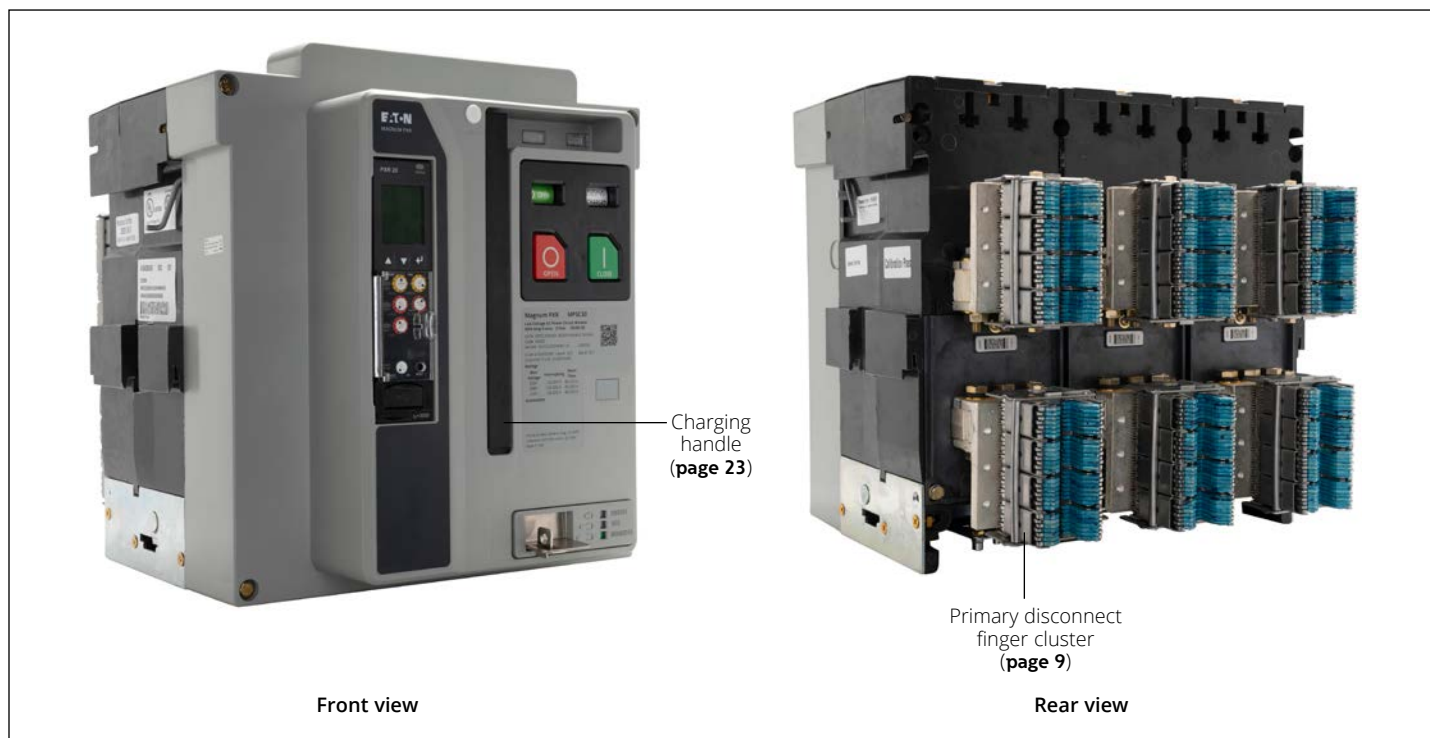
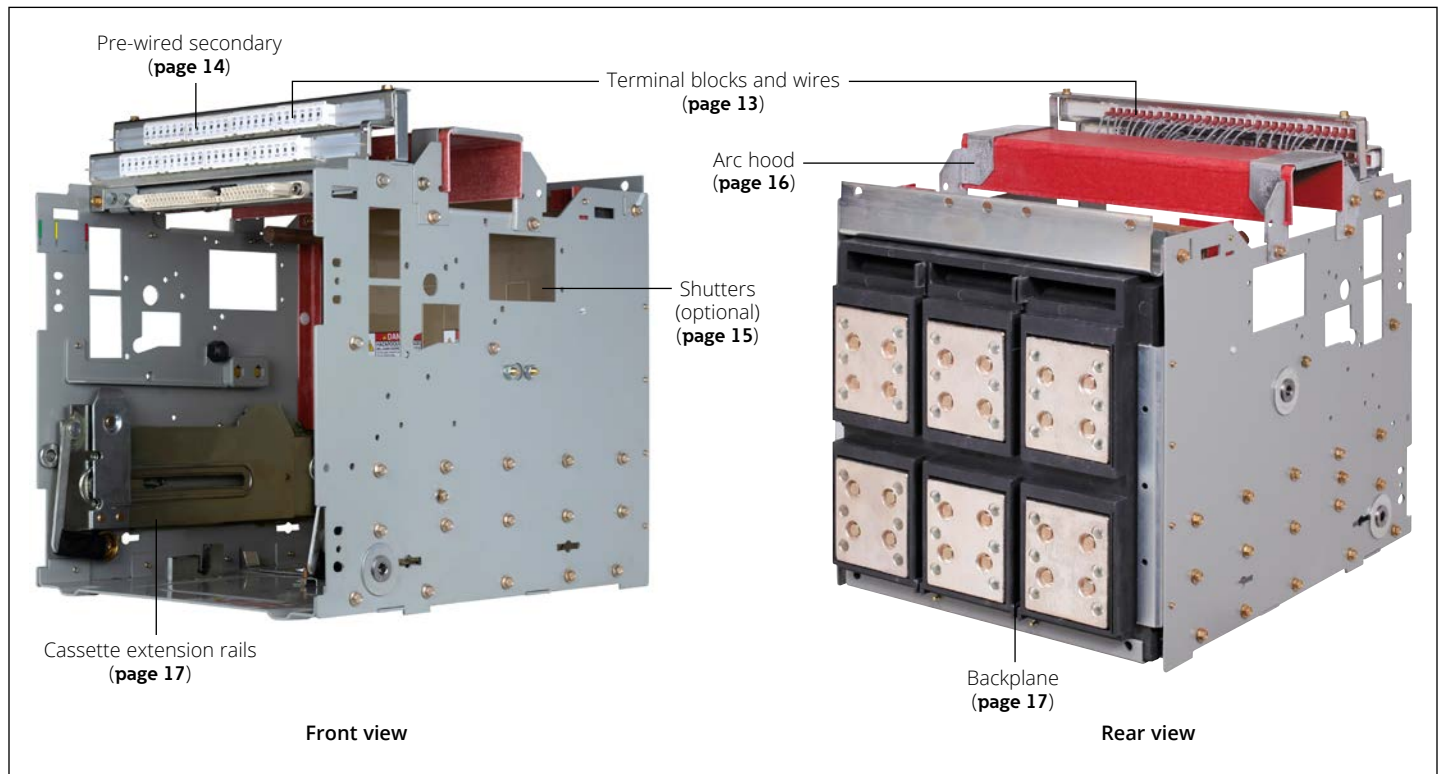

Figure 2. Magnum drawout breaker (800–3200 A), standard frame shown; narrow frame (800–1600 A) available, not shown



**Figure 3. Magnum drawout breaker (ANSI 4000–6000 A, IEC 4000–6300 A), standard double wide; double narrow frame (4000–5000 A) available, not shown**



**Figure 4. Magnum drawout cassette (800–3200 A), universal standard frame OEM cassette shown**

## Breaker mechanism and related parts

Table 1. Magnum PXR/PD-SB mechanism kits

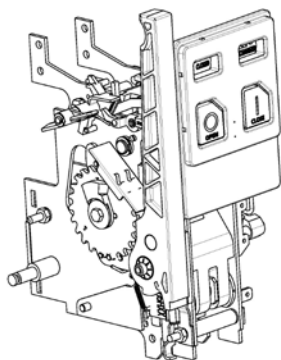

Frame size	Continuous ampere rating (A)	Interrupting rating (kA)	Style number	
			Three-pole ①	Four-pole ②
Narrow	800–2000	Up to 100	2C13205G34	2C13205G35
Standard	800–1600	Up to 65	2C13205G34	2C13205G38
	800–1600	85–100	2C13205G36	2C13205G60
	2000	Up to 100	2C13205G40	2C13205G60
	2500–3200	Up to 100	2C13205G40	2C13205G60
Double narrow	4000–5000	Up to 100	2C13205G63	2C13205G64
Double standard	4000–6000	85–100	2C13205G63	2C13205G64

① Three-pole double-frame breakers have six poles.

② Four-pole double-frame breakers have eight poles.

Table 2. Magnum DS/SB/IEC mechanism kits

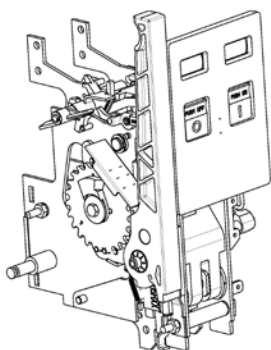

Frame size	Continuous ampere rating (A)	Interrupting rating (kA)	Style number	
			Three-pole ①	Four-pole ②
Narrow	800–2000	Up to 100	2C13202A34	2C13202A35
Standard	800–1600	Up to 65	2C13202A34	2C13202A38
	800–1600	85–100	2C13202A36	2C13202A60
	2000–3200	Up to 100	2C13202A40	2C13202A60
	800	200	2C13202A34	—
	1200–2000	150–200 (MDSX)	2C13202A61	—
	1200–2000	200 (MDSL)	2C13202A36	—
	3200	130	2C13202A40	—
Double narrow	4000–5000	Up to 100	2C13202A63	2C13202A64
Double standard	4000–6000	85–100	2C13202A63	2C13202A64
	4000–5000	130	2C13202A63	—
	2500–5000	150–200	2C13202A65	—

① Three-pole double-frame breakers have six poles.

② Four-pole double-frame breakers have eight poles.

Table 3. Breaker accessories tray

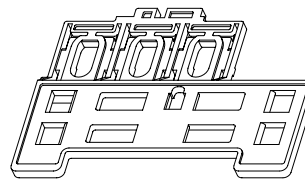

Description	Style number
Plug-in accessory tray	2A10891G01

Table 4. Breaker off key interlock provision

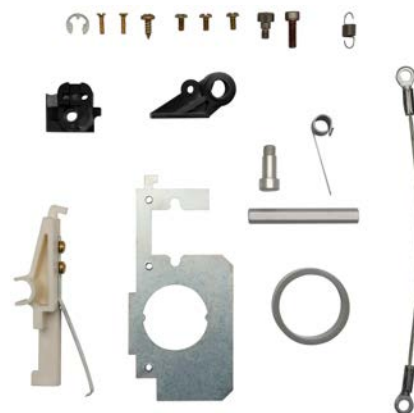

Description	Lock required ①	Key required ①	Catalog/ style number
Ronis	#RBA90GEL3000	Protect	MBRLCKR
Castell	CL1019	CL1062	MBRLCKC
Kirk	KC40---10	KC40	MBRLCKK
CES	#5256E	CES	MBRLCKE
Front cover key interlock hole plug	—	—	76260DK12H

① Eaton does not supply lock or key, only the mounting provision.

Table 5. Operations counter kit

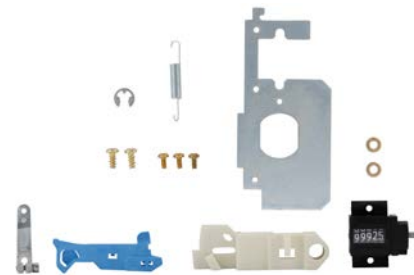

Description	Catalog number
Mechanical counter	MCCOUNT

**Table 6. Replacement levering doors and covers**

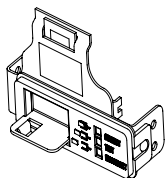

Hardware Included

Breaker type	Breaker mounting	Color	Style number
Magnum PXR, Magnum DS	Drawout	Medium grey	2A10894G02
PD-SB, Magnum SB	Drawout	Light grey	2A10894G03
Magnum IEC	Drawout	Dark grey	2A10894G01
Magnum PXR, Magnum DS	Fixed	Medium grey	2C12815H02
PD-SB, Magnum SB	Fixed	Light grey	2C12815H01
Magnum IEC	Fixed	Dark grey	2C12815H03

**Table 7. Magnum PXR/PD-SB levering mechanism kits**

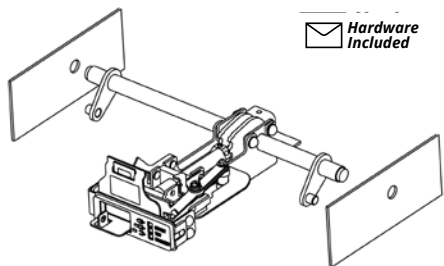

Hardware Included

Breaker type	Frame size	Color	Catalog number	
			Three-pole ①	Four-pole ②
Magnum PXR (MPS)	Standard	Medium grey	MGMP53LEVIN	MGMP54LEVIN
Magnum PXR (MPS)	Double	Medium grey	MGMP66LEVIN	MGMP88LEVIN
Magnum PXR (MPN)	Narrow	Medium grey	MGMPN3LEVIN	MGMPN4LEVIN
Magnum PXR (MPN)	Double narrow	Medium grey	MGMPN6LEVIN	MGMPN8LEVIN
PD-SB (SPS)	Standard	Light grey	MGSP53LEVIN	MGSP54LEVIN
PD-SB (SPS)	Double	Light grey	MGSP66LEVIN	MGSP88LEVIN
PD-SB (SPN)	Narrow	Light grey	MGSPN3LEVIN	MGSPN4LEVIN
PD-SB (SPN)	Double narrow	Light grey	MGSPN6LEVIN	MGSPN8LEVIN
MR2 (MPS/SPS)	Standard	Blue	MGMR2S3LEVIN	MGMR2S4LEVIN
MR2 (MPS/SPS)	Double	Blue	MGMR2S6LEVIN	MGMR2S8LEVIN
MR2 (MPN/SPN)	Narrow	Blue	MGMR2N3LEVIN	MGMR2N4LEVIN
MR2 (MPN/SPN)	Double narrow	Blue	MGMR2N6LEVIN	MGMR2N8LEVIN

① Three-pole double-frame breakers have six poles.

② Four-pole double-frame breakers have eight poles.

**Table 8. Magnum DS/SB/IEC levering mechanism kits**

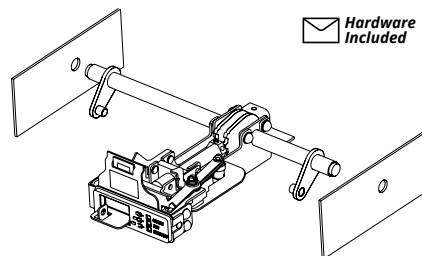

Hardware Included

Breaker type	Frame size	Color	Style number	
			Three-pole ①	Four-pole ②
Magnum DS (MDS)	Standard	Medium grey	2A10855G05	2A10855G06
Magnum DS (MDS)	Double	Medium grey	2A10855G07	2A10855G08
Magnum DS (MDN)	Narrow	Medium grey	2A10855G15	2A10855G16
Magnum DS (MDN)	Double narrow	Medium grey	2A10855G19	2A10855G20
Magnum SB (SBS)	Standard	Light grey	2A10855G01	2A10855G02
Magnum SB (SBS)	Double	Light grey	2A10855G03	2A10855G04
Magnum SB (SBN)	Narrow	Light grey	2A10855G11	2A10855G12
Magnum SB (SBN)	Double narrow	Light grey	2A10855G17	2A10855G18
Magnum IEC (MWI)	Standard	Dark grey	2A10855G25	2A10855G26
Magnum IEC (MWI)	Double	Dark grey	2A10855G27	2A10855G28
Magnum IEC (MWN)	Narrow	Dark grey	2A10855G21	2A10855G22
Magnum IEC (MWN)	Double narrow	Dark grey	2A10855G23	2A10855G24

① Three-pole double-frame breakers have six poles.

② Four-pole double-frame breakers have eight poles.

**Table 9. Magnum PXR/PD-SB faceplate, buttons, and flags**

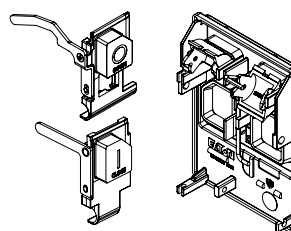

Hardware Included

Description	Style number
Faceplate, buttons, and flags	2A10895G11

**Table 10. Magnum DS/SB/IEC faceplate, buttons, and flags**

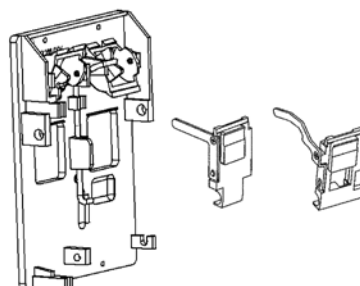

Hardware Included

Description	Style number
Faceplate, buttons, and flags	2A10895G01
Reverse color kit (includes faceplate with buttons and flags)	2A10895G99

## Current path components

Table 11. Breaker stationary contact kit

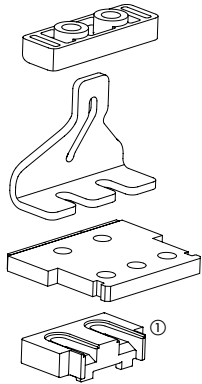

Hardware Included

Standard frame shown

Frame size	Standard	Continuous ampere rating (A)	Interrupting rating (kA)	Style number	
				Three-pole <sup>①</sup>	Four-pole <sup>②</sup>
Standard	ANSI	800	42	<b>2A10896G02</b>	<b>2A10896G06</b>
Standard	ANSI	800/1200/1600	50/65	<b>2A10896G02</b>	<b>2A10896G06</b>
Standard	ANSI	800/1200/1600	85/100	<b>2A10896G03</b>	<b>2A10896G07</b>
Standard	ANSI	800 (MDSL)	200	<b>2A10896G02</b>	—
Standard	ANSI	1200/1600 (MDSL)	200	<b>2A10896G03</b>	—
Standard	ANSI	1200/1600/2000 (MDSX)	200	<b>2A10896G23</b>	—
Standard	ANSI	1200/1600/2000 (SBSE)	150	<b>2A10896G23</b>	—
Standard	ANSI	2000	Up to 100	<b>2A10896G03</b>	<b>2A10896G07</b>
Standard	ANSI	2000 (MDSL)	200	<b>2A10896G04</b>	—
Standard	ANSI	2500/3000/3200	Up to 100	<b>2A10896G04</b>	<b>2A10896G08</b>
Double standard	ANSI	3200/4000/5000 (MDSX)	200	<b>2A10896G23</b> <sup>③</sup>	—
Double standard	ANSI	3200/4000/5000 (MDDX)	200	<b>2A10896G04</b> <sup>③</sup>	—
Double standard	ANSI	4000	85/100	<b>2A10896G03</b> <sup>③</sup>	<b>2A10896G07</b> <sup>③</sup>
Double standard	ANSI	5000/6000	85/100	<b>2A10896G04</b> <sup>③</sup>	<b>2A10896G08</b> <sup>③</sup>
Double standard	ANSI	4000/5000/6000	130	<b>2A10896G04</b> <sup>③</sup>	—
Double standard	ANSI	4000 (SBSE)	150	<b>2A10896G04</b> <sup>③</sup>	—
Double standard	ANSI	5000 (SBSE)	150	<b>2A10896G23</b> <sup>③</sup>	—
Narrow	ANSI	800/1200/1600/2000	Up to 100	<b>2A10896G12</b>	<b>2A10896G15</b>
Double narrow	ANSI	4000/5000	Up to 100	<b>2A10896G21</b> <sup>③</sup>	<b>2A10896G22</b> <sup>③</sup>
Standard	IEC	800/1000/1250/1600	40/65	<b>2A10896G02</b>	<b>2A10896G06</b>
Standard	IEC	800/1000/1250/1600	85/100	<b>2A10896G03</b>	<b>2A10896G07</b>
Standard	IEC	2000	65/85/100	<b>2A10896G03</b>	<b>2A10896G07</b>
Standard	IEC	2500/3200	65/85/100/125	<b>2A10896G04</b>	<b>2A10896G08</b>
Standard	IEC	4000	65/85/100	<b>2A10896G04</b>	<b>2A10896G08</b>
Double standard	IEC	4000	65/85/100	<b>2A10896G03</b> <sup>③</sup>	<b>2A10896G07</b> <sup>③</sup>
Double standard	IEC	5000/6300	85/100	<b>2A10896G04</b> <sup>③</sup>	<b>2A10896G04</b> <sup>③</sup>
Narrow	IEC	800/1000/1250/1600/2000	40/50/65	<b>2A10896G12</b>	<b>2A10896G15</b>
Double narrow	IEC	4000	65/85/100	<b>2A10896G21</b> <sup>③</sup>	<b>2A10896G08</b> <sup>③</sup>

① Three-pole double-frame breakers have six poles.

② Four-pole double-frame breakers have eight poles.

③ Quantity of two required for double-frame breakers.

**Table 12. Moving contact kit**

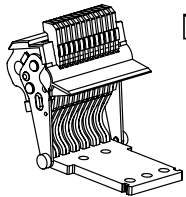

 *Hardware included*

2000 A contacts shown

Frame size	Standard	Continuous ampere rating (A)	Interrupting rating (kA)	Style number	
				Three-pole <sup>①</sup>	Four-pole <sup>②</sup>
Standard	ANSI	800	42	<b>2A10897G01</b>	<b>2A10897G05</b>
Standard	ANSI	800/1200/1600	50/65	<b>2A10897G02</b>	<b>2A10897G06</b>
Standard	ANSI	800/1200/1600	85/100	<b>2A10897G03</b>	<b>2A10897G07</b>
Standard	ANSI	800 (MDSL)	200	<b>2A10897G02</b>	—
Standard	ANSI	1200/1600 (MDSL)	200	<b>2A10897G03</b>	—
Standard	ANSI	1200/1600/2000 (MDSX)	200	<b>2A10897G27</b>	—
Standard	ANSI	1200/1600/2000 (SBSE)	150	<b>2A10897G27</b>	—
Standard	ANSI	2000	65/85/100	<b>2A10897G03</b>	<b>2A10897G07</b>
Standard	ANSI	2000 (MDSL)	200	<b>2A10897G04</b>	—
Standard	ANSI	2500/3000/3200	65/85/100	<b>2A10897G04</b>	<b>2A10897G08</b>
Double standard	ANSI	2500/3000 (SBSE)	150	<b>2A10897G27</b> <sup>③</sup>	—
Double standard	ANSI	3200/4000/5000 (MDSE)	150	<b>2A10897G27</b> <sup>③</sup>	—
Double standard	ANSI	3200/4000/5000 (MDSX)	200	<b>2A10897G27</b> <sup>③</sup>	—
Double standard	ANSI	3200/4000/5000 (MDDX)	200	<b>2A10897G10</b> <sup>③</sup>	—
Double standard	ANSI	4000	85/100	<b>2A10897G09</b> <sup>③</sup>	<b>2A10897G11</b> <sup>③</sup>
Double standard	ANSI	5000/6000	85/100	<b>2A10897G10</b> <sup>③</sup>	<b>2A10897G12</b> <sup>③</sup>
Double standard	ANSI	4000/5000/6000	130	<b>2A10897G10</b> <sup>③</sup>	—
Double standard	ANSI	4000/5000 (SBSE)	150	<b>2A10897G27</b> <sup>③</sup>	—
Narrow	ANSI	800/1200/1600/2000	Up to 100	<b>2A10897G22</b>	<b>2A10897G24</b>
Double narrow	ANSI	4000/5000	Up to 100	<b>2A10897G25</b> <sup>③</sup>	<b>2A10897G26</b> <sup>③</sup>
Standard	IEC	800	40	<b>2A10897G01</b>	<b>2A10897G05</b>
Standard	IEC	1000/1250	40	<b>2A10897G02</b>	<b>2A10897G06</b>
Standard	IEC	800/1000/1250/1600	65	<b>2A10897G02</b>	<b>2A10897G06</b>
Standard	IEC	800/1000/1250/1600	85/100	<b>2A10897G03</b>	<b>2A10897G07</b>
Standard	IEC	2000	65/85/100	<b>2A10897G03</b>	<b>2A10897G07</b>
Standard	IEC	2500/3200	65/85/100/125	<b>2A10897G04</b>	<b>2A10897G08</b>
Double standard	IEC	4000	65/85/100	<b>2A10897G09</b> <sup>③</sup>	<b>2A10897G11</b> <sup>③</sup>
Double standard	IEC	5000/6300	85/100	<b>2A10897G10</b> <sup>③</sup>	<b>2A10897G12</b> <sup>③</sup>
Narrow	IEC	800/1000/1250/1600	40/50	<b>2A10897G21</b>	<b>2A10897G23</b>
Narrow	IEC	800/1000/1250/1600	65	<b>2A10897G22</b>	<b>2A10897G24</b>
Narrow	IEC	2000	50/65	<b>2A10897G22</b>	<b>2A10897G24</b>
Double narrow	IEC	4000	65/85/100	<b>2A10897G25</b> <sup>③</sup>	<b>2A10897G26</b> <sup>③</sup>

① Three-pole double-frame breakers have six poles.

② Four-pole double-frame breakers have eight poles.

③ Quantity of two required for double-frame breakers.

Table 13. Primary disconnect kit (finger clusters) ①

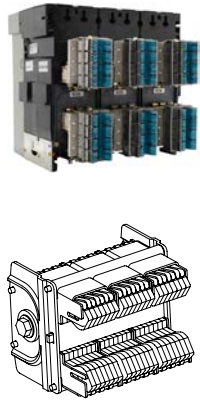

Frame size	Standard	Continuous ampere rating (A)	Interrupting rating (kA)	Style number	
				Three-pole ②	Four-pole ③
Standard	ANSI	800	42	2A10898G09	2A10898G13
Standard	ANSI	800/1200/1600	50/65	2A10898G10	2A10898G14
Standard	ANSI	800/1200/1600	85/100	2A10898G11	2A10898G15
Standard	ANSI	800 (MDSL)	200	2A10898G36	—
Standard	ANSI	1200/1600 (MDSL)	200	2A10898G11	—
Standard	ANSI	1200/1600/2000 (MDSX)	200	2A10898G12	—
Standard	ANSI	1200/1600/2000 (SBSE)	150	2A10898G12	—
Standard	ANSI	2000	65/85/100	2A10898G11	2A10898G15
Standard	ANSI	2000 (MDSL)	200	2A10898G12	—
Standard	ANSI	2500/3000/3200	65/85/100	2A10898G12	2A10898G16
Double standard	ANSI	2500/3000 (SBSE)	150	2A10898G12 ④	—
Double standard	ANSI	3200/4000/5000 (MDSE)	150	2A10898G12 ④	—
Double standard	ANSI	3200/4000/5000 (MDSX/MDDX)	200	2A10898G12 ④	—
Double standard	ANSI	4000	85/100	2A10898G11 ④	2A10898G15
Double standard	ANSI	5000/6000	85/100	2A10898G12 ④	2A10898G16
Double standard	ANSI	4000/5000 (SBSE)	150	2A10898G12 ④	—
Narrow	ANSI	800/1200/1600	Up to 100	2A10898G29 ①	2A10898G26
Double narrow	ANSI	4000 (horizontal)	65/85/100	2A10898G34 ①④	2A10898G35 ①④
Double narrow	ANSI	4000/5000 (vertical interleaf)	65/85/100	2A10898G12 ①④	2A10898G16 ①④
Standard	IEC	800	40	2A10898G01	2A10898G05
Standard	IEC	1000/1250	40	2A10898G02	2A10898G06
Standard	IEC	800/1000/1250/1600	65	2A10898G02	2A10898G06
Standard	IEC	800/1000/1250/1600	85/100	2A10898G03	2A10898G07
Standard	IEC	2000	65/85/100	2A10898G03	2A10898G07
Standard	IEC	2500/3200	65/85/100/125	2A10898G04	2A10898G08
Standard	IEC	4000	65/85/100	2A10898G04	2A10898G08
Double standard	IEC	4000	65/85/100	2A10898G03 ④	2A10898G07 ④
Double standard	IEC	5000/6300	85/100	2A10898G04 ④	2A10898G08 ④
Narrow	IEC	800/1000/1250	40	2A10898G21	2A10898G25
Narrow	IEC	800/1000/1250/1600/2000	50/65	2A10898G22	2A10898G26
Double narrow	IEC	4000	65/85/100	2A10898G34 ④	2A10898G35 ④

① For narrow and double-narrow frame breakers installed in Eaton low-voltage switchgear, contact your local Eaton sales representative.

② Three-pole double-frame breakers have six poles.

③ Four-pole double-frame breakers have eight poles.

④ Quantity of two required for double-frame breakers.

**Table 14. Drawout breaker primary disconnect vertical adapter kits ①**

Frame size	Continuous ampere rating (A)	Interrupting rating (kA)	Catalog/style number	
			Three-pole ②	Four-pole ③
Standard	800–1600	Up to 65	MVADP16	MVADP416
Standard	800–1600	85–100	2A11795G51	2A11795G52
Standard	2000	Up to 100	2A11795G51	2A11795G52
Standard	1200–2000	200	2A11795G53	—
Standard	2500–3000	Up to 100	2A11795G53	2A11795G54
Standard	3200	Up to 100	MVADPF32 ④	MVADP430 ④
Double	3200	150–200	2A11795G57	—
Double	4000	Up to 100	2A11795G55	2A11795G56
Double	4000–5000	130–200	2A11795G57	—
Double	5000–6000	Up to 100	2A11795G57	2A11795G58
Double narrow	4000–5000	Up to 100	2A11795G59 ④	2A11795G60 ④

① For narrow and double-narrow frame breakers installed in Eaton low-voltage switchgear, contact your local Eaton sales representative.

② Three-pole double-frame breakers have six poles.

③ Four-pole double-frame breakers have eight poles.

④ Includes heat sinks.

**Table 15. Fixed breaker vertical adapter terminal adapter kits**

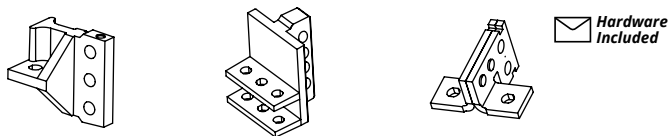

Frame size	Continuous ampere rating (A)	Interrupting rating (kA)	Catalog number	
			Three-pole ①	Four-pole ②
Standard	800–1600	Up to 65	MVADP16	MVADP416
Standard	800–1600	85–100	MVADP20	MVADP420
Standard	2000	Up to 100	MVADP20	MVADP420
Standard	1200–2000	200	MVADP32	—
Standard	2500–3200	Up to 100	MVADP32	MVADP432
Double	3200	150–200	MVADP50	—
Double	4000	Up to 100	MVADP40	MVADP440
Double	4000–5000	130–200	MVADP50	—
Double	5000–6300	Up to 100	MVADP50	MVADP450
Narrow	800–2000	Up to 100	MVADP320N	MVADP420N
Double narrow	4000	Up to 100	MVADP340N	MVADP440N

① Three-pole double-frame breakers have six poles.

② Four-pole double-frame breakers have eight poles.

**Table 16. Front-mounted terminal kits**

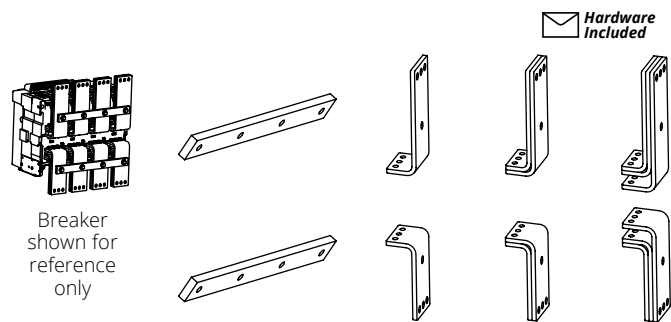

Frame size	Continuous ampere rating (A)	Interrupting rating (kA)	Catalog number	
			Three-pole	Four-pole
Standard	800–1200	Up to 100	SFNTC312	SFNTC412
Standard	1600–2500	Up to 100	SFNTC325	SFNTC425
Standard	3200	Up to 100	SFNTC332	SFNTC432
Narrow	800–1200	Up to 65	NFC312KT	NFC412KT
Narrow	1600–2000	Up to 65	NFC320KT	NFC420KT

**Table 17. Current-limiting fuse kit for MDSL breakers ①**

Description	Style number
MA250	2A10395G02
MA300	2A10395G03
MA400	2A10395G04
MA600	2A10395G05
MA800	2A10395G06
MB1200	2A10395G07
MB1600	2A10395G08
MB2000	2A10395G09
MD2500	2A10395G15
MD3000	2A10395G16
MD3000 with heat sinks	2A10395G17
Magnum blown fuse and trip indicator	70C1273G01

① Fuse kit includes three fuses and mounting hardware.

## Electrical accessories

**Table 18. Shunt trip (opening coil) kits**



Control voltage	Type	15th digit in breaker catalog number	Catalog number
110–127 Vac/Vdc	Standard duty	A	<b>MST1</b>
208–240 Vac/Vdc	Standard duty	R	<b>MST2</b>
24 Vdc	Standard duty	C	<b>MST3</b>
48 Vdc	Standard duty	H	<b>MST4</b>
110–127 Vac/Vdc	Continuous duty	B	<b>MSTA</b>
60 Vdc	Continuous duty	J	<b>MSTD</b>
48 Vdc	Continuous duty	K	<b>MSTH</b>
24 Vdc	Continuous duty	D	<b>MSTL</b>
208–240 Vac/Vdc	Continuous duty	S	<b>MSTR</b>

**Table 19. Spring release (closing coil) kits**



Control voltage	17th digit in breaker catalog number	Catalog number
110–127 Vac/Vdc	A	<b>MSRA</b>
208–240 Vac/Vdc	R	<b>MSRR</b>
24 Vdc	C	<b>MSRC</b>
48 Vdc	H	<b>MSRH</b>
60 Vdc	S	<b>MSRS</b>

**Table 20. Undervoltage release kits**



Control voltage	18th digit in breaker catalog number	Catalog number	
110–125 Vac	A	<b>MUVRA</b>	
208–240 Vac	R	<b>MUVRR</b>	
24 Vdc	C	<b>MUVRC</b>	
32 Vdc	G	<b>MUVRG</b>	
48 Vdc	H	<b>MUVRH</b>	
110–125 Vdc	E	<b>MUVRE</b>	
220–250 Vdc	F	<b>MUVRF</b>	
380–415 Vac	X	<b>MUVRX</b>	
480 Vac	J	<b>MUVRJ</b>	
600 Vac	K	<b>MUVRK</b>	
60 Vdc	D	<b>MUVRS</b>	
110–125 Vac	Time delay	—	<b>MTDUVR120V</b> ①
208–240 Vac	Time delay	—	<b>MTDUVR320V</b> ①

① Externally mounted module to be used with an internal UVR of the same voltage rating.

**Table 21. Auxiliary switch kits ①**



Control voltage	Catalog number
2a/2b contacts	<b>MAUX2</b>
4 Form C contacts	<b>MAUXSW4C</b>

① Maximum of three auxiliary switch kits can be installed in a breaker. Magnum PXR and PD-SB secondary terminals are labeled for MAUXSW4C. Magnum DS, SB, and IEC secondary terminals are labeled for MAUX2.

**Table 22. Motor operator kits**



Control voltage	Charging time (sec)	16th digit in breaker catalog number	Catalog number
24 Vdc	5	L	MMOTL
48 Vdc	5	K	MMOTK
60 Vdc	5	S	MMOTS
110–125 Vac/Vdc	5	N or W	MMOTW
208–240 Vac/Vdc	5	P or T	MMOTT
24 Vdc	3	4	MMOT3
48 Vdc	3	8	MMOT4
110–125 Vac/Vdc	3	1 or 5	MMOT1
208–240 Vac/Vdc	3	2 or 9	MMOT2

**Table 23. Breaker pop-out trip indicator with switches and bell alarm—overcurrent trip switch (OTS)**



Mechanical trip indicator	Mechanical interlock	Bell alarm (OTS) contacts	20th digit in breaker catalog number	Catalog number
Yes	No	None	N	MDTRIND
Yes	No	2 Form C	Y	MDTRINDBA
Yes	Yes	1 Form C with 230 Vac / 250 Vdc remote reset	K	MRRTS230AD
Yes	Yes	1 Form C with 120 Vac / 125 Vdc remote reset	J	MRRTS120AD
Yes	Yes	1 Form C with 24 Vdc remote reset	I	MRRTS24AD
Yes	Yes	None	M	MINTTRIND
Yes	Yes	2 Form C	L	MNTRINDBA
No	—	2 Form C	—	MOTS ①
White hole plug	—	—	—	76260FAB02

① Requires breaker to be equipped with pop-out visual trip indicator assembly.

**Table 24. Latch check switch**

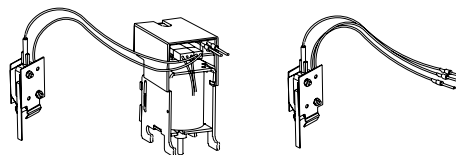

Description	23rd digit in breaker catalog number	Catalog number
Use with spring release ①	L or Y	MLCS1
Form C contact for remote indication	C or D	MLCS2

① Spring release sold separately; refer to **Table 19** for catalog numbers.

## Secondary wiring, repair, and replacement

**Table 25. Magnum PXR/PD-SB secondary repair kit ①**

Description	Catalog number
(1) Ampere pin removal tool; (1) Six-point terminal block; (1) Label set; (1) Female 84-point ampere connector (cassette side secondary terminal housing); (1) Male 84-point ampere connector (breaker side secondary terminal housing); (10) Wire assemblies with terminal connectors (ampere and fast-on terminals on opposite ends); (2) 40-inch wires with ampere terminals on one end; (5) Fast-on terminals	MSECTOOLPXR

① Additional wires and terminal blocks can be found in **Table 27**.

**Table 26. Magnum DS/SB/IEC secondary repair kit ①②**

Hardware Included



Description	Catalog number
(1) Ampere pin removal tool; (1) Six-point terminal block; (1) Six-point PXR blank label; (1) Female 30-point ampere connector (cassette side secondary terminal housing); (1) Male 30-point ampere connector (breaker side secondary terminal housing); (10) Wire assembly	MSECTOOL

① For use with Digitrip trip units only.

② Additional wires and terminal blocks can be found in **Table 27**.

**Table 27. Secondary terminal blocks and wires**

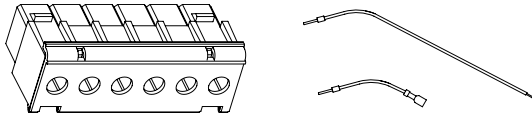

Description	Catalog/ style number
(15) Six-point terminal blocks and labels	MSECBK
C1 through C84 secondary terminal block label set	1B93092G21
90 wires with terminal connectors (ampere and fast-on terminals on opposite ends)	MSECWR
30 wires, 40 inches long (ampere pin on one end only)	MWK40
Extension bracket kit (to mount three six-point terminal blocks on side of cassette)	MEXTBKIT
Extension bracket long wires (18 wires, 55 inches long)	MEXTBWKIT

**Table 28. Magnum PXR/PD-SB breaker terminal block bracket**

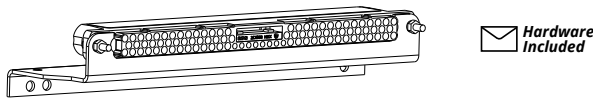

Description	Catalog number
84-point secondary plus eight tertiary (MR2) terminal (female) housing and bracket	MDOBKRSEC

**Table 29. Magnum DS/SB/IEC breaker terminal block bracket**

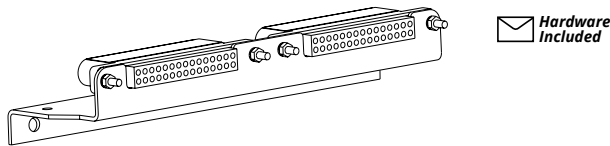

Description	Catalog number
(2) 30-point secondary terminal housing (female) and bracket	MDOACBSECTB

**Table 30. Magnum PXR/PD-SB cassette secondary disconnect block**

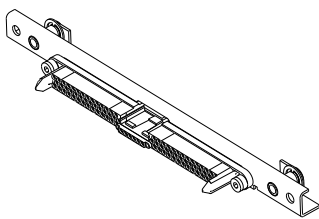

Description	Frame size	Catalog number
84-point secondary plus eight tertiary (MR2) terminal housing and bracket	Standard and double standard	MSDOCASEC
	Narrow and double narrow	MNDOCASEC

**Table 31. Magnum DS/SB/IEC cassette secondary disconnect block**

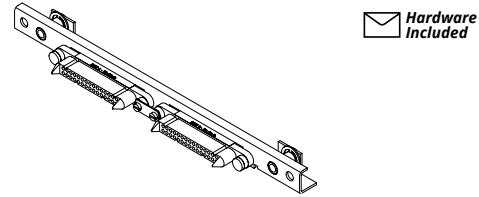

Description	Frame size	Catalog number
(2) 30-point secondary terminal housing and bracket	Standard and double standard	MDOCASSECTB
	Narrow and double narrow	MDNCASSECTB

**Table 32. Magnum PXR/PD-SB fixed-mounted breaker secondary disconnect block**

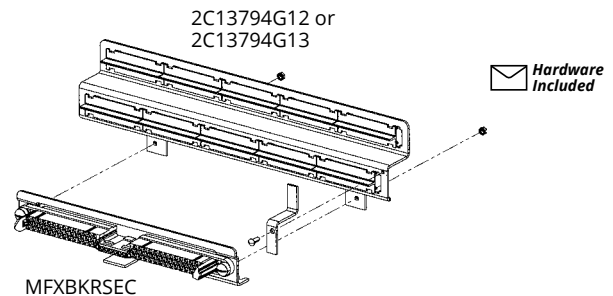

Description	Frame size	Catalog/ style number
84-point secondary terminal housing (male) and bracket	All	MFXBKRSEC
Secondary terminal block mounting bracket	Standard, double standard, and double narrow	2C13794G12
	Narrow	2C13794G13

**Table 33. Magnum DS/SB/IEC fixed-mounted breaker secondary disconnect block**

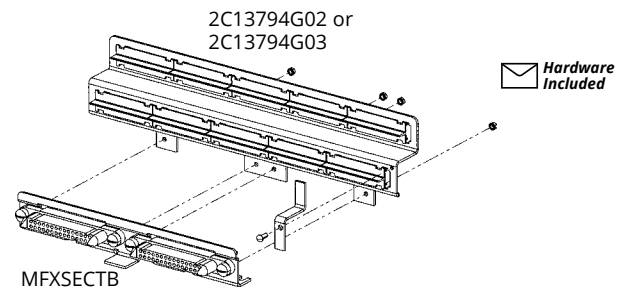

Description	Frame size	Catalog/ style number
(2) 30-point secondary terminal housing (male) and bracket	All	MFXSECTB
Secondary terminal block mounting bracket	Standard, double standard, and double narrow	2C13794G02
	Narrow	2C13794G03

**Table 34. Magnum PXR/PD-SB pre-wired secondary terminal block assemblies**



Description	Wiring	Frame size	Trip unit	Catalog number	
				Three-pole ①	Four-pole ②
Cassette secondary assembly	Fully wired ③	Standard	PXR 20/25	<b>MS3CASTBFW</b>	<b>MS4CASTBFW</b>
Cassette secondary assembly	Fully wired ③	Double standard	PXR 20/25	<b>MSD3CASTBFW</b>	<b>MSD4CASTBFW</b>
Cassette secondary assembly	Fully wired ③	Narrow	PXR 20/25	<b>MN3CASTBFW</b>	<b>MN4CASTBFW</b>
Cassette secondary assembly	Fully wired ③	Double narrow	PXR 20/25	<b>MND3CASTBFW</b>	<b>MND4CASTBFW</b>
Fixed secondary contact assembly	Required and common wired ④	Narrow	PXR 20/25	<b>MN3FXTBCW</b>	<b>MN3FXTBCW</b>
Fixed secondary contact assembly	Required and common wired ④	Standard	PXR 20/25	<b>MS3FXTBCW</b>	<b>MS3FXTBCW</b>
Fixed secondary contact assembly	Required and common wired ④	Double standard	PXR 20/25	<b>MS3FXTBCW</b>	<b>MS3FXTBCW</b>
Fixed secondary contact assembly	Required and common wired ④	Double narrow	PXR 20/25	<b>MS3FXTBCW</b>	<b>MS3FXTBCW</b>

- ① Three-pole double-frame breakers have six poles.
- ② Four-pole double-frame breakers have eight poles.
- ③ Includes twelve terminal blocks.
- ④ Includes eight terminal blocks.

**Table 35. Magnum DS/SB/IEC pre-wired secondary terminal block assemblies**



Description	Wiring	Frame size	Style number	
			Three-pole ①	Four-pole ②
Cassette secondary assembly	Prewired	Standard	<b>2C13694G11</b>	<b>2C13694G12</b>
Cassette secondary assembly	Prewired	Double standard	<b>2C13694G13</b>	<b>2C13694G14</b>
Cassette secondary assembly	Prewired	Narrow	<b>2C13694G33</b>	<b>2C13694G34</b>
Cassette secondary assembly	Prewired	Double narrow	<b>2C13694G43</b>	<b>2C13694G44</b>
Fixed secondary contact assembly	Prewired	Standard, double standard, double narrow	<b>2C13791G15</b>	<b>2C13791G15</b>
Fixed secondary contact assembly	Prewired	Narrow	<b>2C13791G16</b>	<b>2C13791G16</b>

- ① Three-pole double-frame breakers have six poles.
- ② Four-pole double-frame breakers have eight poles.

## Cassette (cell) attachments

**Table 36. Cell switch kits**

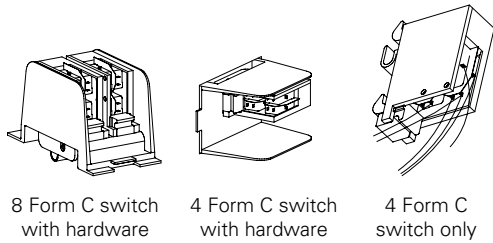

Description	Standard	Switch contacts	Hardware	Catalog/ style number
Standard, double standard, double narrow (vertical)	ANSI	4 Form C contacts	Included	<b>MD4CS</b>
Standard, double standard, double narrow (vertical)	ANSI	8 Form C contacts	Included	<b>MD8CS</b>
Standard, double standard, double narrow (vertical)	ANSI	4 Form C contacts	Not included	<b>MDCELLSW1</b>
Narrow, double narrow (horizontal)	ANSI	4 Form C contacts	Included	<b>M4CS</b>
All	IEC	(3) 4 Form C contacts	Included	<b>M12CS</b>
All	IEC	(2) 4 Form C contacts	Included	<b>M8CS</b>
All	IEC	4 Form C contacts	Not included	<b>MICELLSW1</b>

**Table 37. Cassette lock provision** ①

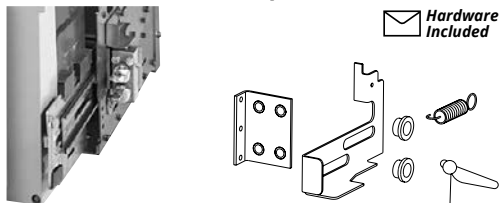

Lock type	Mounting position	Catalog/ style number
Kirk or Castell	Right side	<b>MD4CS</b>
Kirk or Castell	Left side	<b>MD8CS</b>
Kirk	Retainer lock rail	<b>MDCELLSW1</b>
Ronis	Mounting plate	<b>MICELLSW1</b>

① Eaton does not supply lock or key, only the provision. For Kirk, use lock catalog number KFL000021 for two cylinders and KFL000010H for one cylinder. For Castell, use lock catalog number F080000.

**Table 38. Rejection bracket replacement parts**

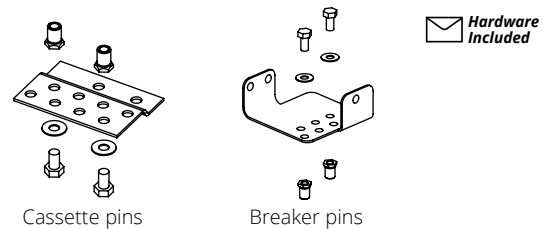

Description	Frame size	Catalog/ style number
Breaker rejection bracket kit	Standard and double standard	<b>2A11893B01</b> ①
Breaker rejection bracket kit	Narrow and double narrow	<b>2A11893A21</b> ①
Cassette rejection bracket kit	Narrow	<b>2C13863G01</b>
Cassette rejection bracket kit	Double narrow	<b>2C13863G02</b>
Cassette rejection bracket kit	Standard	<b>MCELLREJBK</b>
Cassette rejection bracket kit	Double standard	<b>MCELLREJBKDF</b>

① Quantity of two required for double-frame breakers.

**Table 39. Cassette shutters** ①

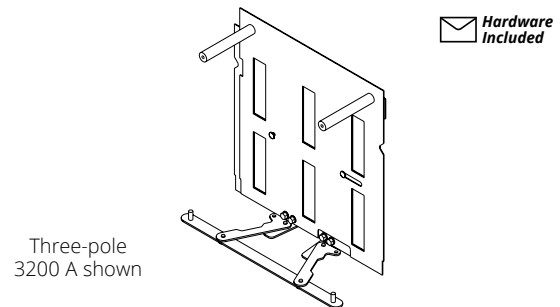

Frame size	Continuous ampere rating (A)	Finger cluster orientation	Catalog number	
			Three-pole ②	Four-pole ③
Standard	800–3200	Vertical	<b>MDSHTR332WL</b>	<b>MDSHTR432WL</b>
Standard	800–3200	Horizontal	<b>MISHTR332</b>	<b>MISHTR432</b>
Double standard	4000–6000	Vertical	<b>MDSHTR350WL</b>	<b>MDSHTR450WL</b>
Double standard	4000–6300	Horizontal	<b>MISHTR363</b>	<b>MISHTR463</b>
Narrow	800–1600	Horizontal	<b>MDNSHTR3P</b>	<b>MDNSHTR4P</b>
Double narrow	4000–5000	Vertical	<b>MINSHTR350VI</b>	<b>MINSHTR450VI</b>
Double narrow	4000	Horizontal	<b>MINSHTR340</b>	<b>MINSHTR440</b>

① For narrow and double-narrow frame breakers installed in Eaton low-voltage switchgear, contact your local Eaton sales representative.

② Three-pole double-frame breakers have six poles.

③ Four-pole double-frame breakers have eight poles.

**Table 40. Terminal adapters for universal drawout cassettes**

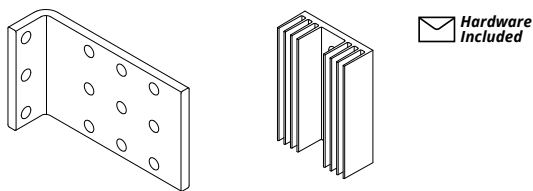

Frame size	Continuous ampere rating (A)	Interrupting rating (kA)	Catalog number	
			Three-pole ①	Four-pole ②
Standard	800–1600	All	<b>MUBADP316</b>	<b>MUBADP416</b>
Standard	2000	Up to 100	<b>MUBADP316</b>	<b>MUBADP416</b>
Standard	2000	150 and 200 (MDSX)	<b>MUBADP332</b> ③ + <b>MUBHS332</b> ④	—
Standard	2000	200 (MDSL)	<b>MUBADP330</b>	—
Standard	2500–3000	Up to 130	<b>MUBADP330</b>	<b>MUBADP430</b>
Standard	3200	Up to 130	<b>MUBADP332</b> ③	<b>MUBADP432</b> ③
Standard	3200	Up to 130	<b>MUBHS332</b> ④	<b>MUBHS432</b> ④
Double standard	2500	150 (SBSE)	<b>MUBADP332</b> ③⑤	—
Double standard	3200	150–200	<b>MUBADP332</b> ③⑤	—
Double standard	4000	Up to 130	<b>MUBADP316</b> ⑤	<b>MUBADP416</b> ⑤
Double standard	4000	150 to 200	<b>MUBADP332</b> ③⑤	—
Double standard	5000	Up to 100	<b>MUBADP332</b> ③⑤	<b>MUBADP432</b> ③⑤
Double standard	5000	130–200	<b>MUBADP332</b> ③⑤	—

- ① Three-pole narrow and double-narrow frames have six poles.
- ② Four-pole narrow and double-narrow frames have eight poles.
- ③ Includes heat sinks.
- ④ Heat sinks only (no bus).
- ⑤ Quantity of two required for double-frame breakers.

**Table 43. Arc hood kits**

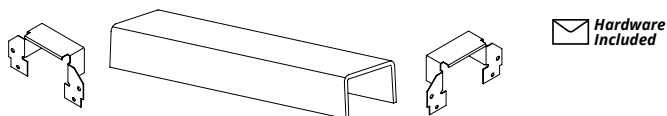

Frame size	Standard	Mounting	Catalog/style number	
			Three-pole ①	Four-pole ②
Standard	ANSI	Cassette	<b>2A11853G01</b>	<b>2A11853G02</b>
Double standard	ANSI	Cassette	<b>2A11853G03</b>	<b>2A11853G04</b>
Narrow	ANSI	Cassette	<b>2A11853G11</b>	<b>2A11853G01</b>
Double narrow	ANSI	Cassette	<b>2A11853G16</b>	<b>2A11853G17</b>
Standard	IEC	Cassette	<b>2A11853G05</b>	<b>2A11853G06</b>
Double standard	IEC	Cassette	<b>2A11853G07</b>	<b>2A11853G08</b>
Narrow	IEC	Cassette	<b>2A11853G15</b>	<b>2A11853G05</b>
Double narrow	IEC	Cassette	<b>2A11853G18</b>	<b>2A11853G19</b>
Standard	ANSI (DC switch)	Cassette	<b>2A12691G01</b>	—
Standard	IEC (DC switch)	Cassette	<b>2A12691G02</b>	—
Standard	ANSI/IEC	Fixed breaker	<b>MKBKF3</b>	<b>MKBKF4</b>
Double standard	ANSI/IEC	Fixed breaker	<b>MKBKF6</b>	<b>MKBKF6</b>
Narrow	ANSI/IEC	Fixed breaker	<b>2C12898G05</b>	<b>2C12898G01</b>
Double narrow	ANSI/IEC	Fixed breaker	<b>2C12898G06</b>	<b>2C12898G07</b>

- ① Three-pole narrow and double-narrow frames have six poles.
- ② Four-pole narrow and double-narrow frames have eight poles.

**Table 41. Vertical terminal adapters for narrow frame and IEC drawout cassettes**

Frame size	Continuous ampere rating (A)	Interrupting rating (kA)	Catalog number	
			Three-pole ①	Four-pole ②
Standard	800–1600	Up to 65	<b>MVADP16</b>	<b>MVADP416</b>
Standard	800–2000	85–100	<b>MVADP20</b>	<b>MVADP420</b>
Standard	2000	Up to 100	<b>MVADP20</b>	<b>MVADP420</b>
Standard	2500–3200	Up to 100	<b>MVADP32</b>	<b>MVADP432</b>
Double standard	4000	Up to 100	<b>MVADP40</b>	<b>MVADP440</b>
Double standard	5000–6300	Up to 100	<b>MVADP50</b>	<b>MVADP450</b>
Narrow	800–2000	Up to 100	<b>MVADP320N</b>	<b>MVADP420N</b>
Double narrow	4000	Up to 100	<b>MVADP340N</b> ③	<b>MVADP440N</b> ③

- ① Three-pole narrow and double-narrow frames have six poles.
- ② Four-pole narrow and double-narrow frames have eight poles.
- ③ Not used with the vertical interleaf cassette.

**Table 42. MR2 integral remote racking**

Description	Catalog/style number
Controller assembly kit	<b>MGMR2CNTRLR</b>
Wire harness kit (cassette side)	<b>MGMR2TRWHK</b>
MR2 pendant with breaker open/close	<b>1C19848G01</b>
MR2 pendant without breaker open/close	<b>1C19848G02</b>

**Table 44. Cassette stab and backplane kits**

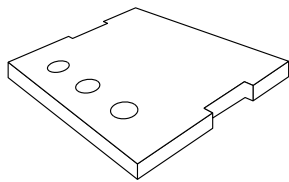

Hardware Included

Catalog number  
2A11850G02 shown

Description	Frame size	Continuous ampere rating (A)	Style number		
			One-pole	Three-pole ①	Four-pole ②
Basic cassette stab kit	Standard and double standard	800–2000 and 4000	2A11850G01 ③	1B93097G01 ④	—
Basic cassette stab kit	Standard and double standard	2500–3200 and 5000–6000	2A11850G02 ③	1B93097G02 ④	—
Basic cassette backplane (no stabs)	Standard	800–2000	—	2A10859G01	—
Basic cassette backplane (no stabs)	Standard	2500–3200	—	2A10859G02	—
Basic cassette backplane (no stabs)	Double standard	4000	—	2A10859G03	—
Basic cassette backplane (no stabs)	Double standard	5000–6000	—	2A10859G04	—
IEC cassette stab kit	Standard and double standard	800–2000 and 4000	2A10857G01 ③	—	—
IEC cassette stab kit	Standard and double standard	2500–3200 and 5000–6300	2A10857G02 ③	—	—
IEC cassette stab kit	Narrow and double narrow	800–2000 and 4000	2A10857G03 ③	—	—
IEC cassette backplane (with stabs)	Standard	800–2000	—	2A10858G01	2A10858G02
IEC cassette backplane (with stabs)	Standard	2500–3200	—	2A10858G05	2A10858G06
IEC cassette backplane (with stabs)	Double standard	4000	—	2A10858G03	2A10858G04
IEC cassette backplane (with stabs)	Double standard	5000–6300	—	2A10858G07	2A10858G08

- ① Three-pole double-frame breakers have six poles.
- ② Four-pole double-frame breakers have eight poles.
- ③ Includes two stabs (for one pole). Order quantity based on number of poles required.
- ④ Quantity of two required for double-frame breakers.

**Table 45. Cassette rail upgrade/replacement kits and anti-rock upgrade**

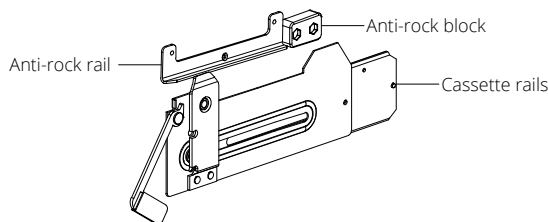

Description	Style number
IEC standard and narrow frame cassette rail upgrade	2A12886G11 ①
Narrow frame cassette rail upgrade	2A12886G11 ①
Double narrow frame (horizontal stabs) cassette rail upgrade	2A12886G12 ①
IEC double standard and double narrow frame cassette rail upgrade	2A12886G12 ①
Universal and basic standard frame cassette rail upgrade	2A12886G13 ①
Universal and basic double standard frame cassette rail upgrade	2A12886G14 ①
Double narrow frame (vertical interleaf) cassette rail upgrade	2A12886G14 ①
Anti-rock upgrade kit	2A12893G01 ②

- ① Includes cassette rails and anti-rock rails/block.
- ② Includes anti-rock rails and block only.

**Table 46. CT shorting block and/or jumper block kit**

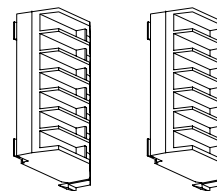

Hardware Included

Description	Catalog number
Cell-to-cell wiring terminations	MJB
Metering CT wire termination	MSB
Cell-to-cell and metering CT wiring terminations	MSJB

## External accessories

**Table 47. Door escutcheon with gasket**

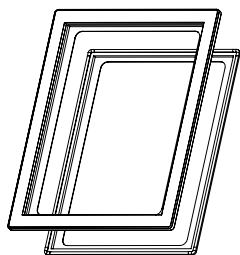

Hardware Included

Description	Color	Catalog number
IP31 protection	Black	MDES
IP41 protection	Black	MDES2

**Table 48. IP55 cover kit (translucent)**

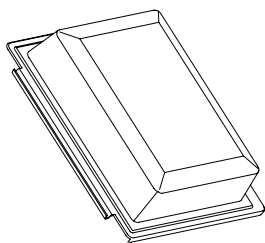

Hardware Included

Description	Catalog number
Provides protection against dust and dripping water (IP55)	MDESC

**Table 49. Padlockable pushbutton covers**

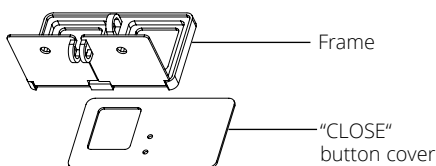

Hardware Included

Description	21st digit in breaker catalog number	Catalog number
Metal frame with blocked close button cover	M or C	MCOVC
Plastic frame with blocked close button cover	P or H	MCOVH
Padlockable pushbutton cover—lockoff, metal	S	MCOVCOFF

**Table 50. Door latch interlock kits**

Description	Catalog number
IEC door latch interlock kit	MDSLKIT
IEC door short latch interlock kit	MDSLKITSH

**Table 51. Breaker maintenance and handling**

Description	Frame size	Style number	
		Three-pole <sup>①</sup>	Four-pole <sup>②</sup>
Lifting yoke	Standard	8651C91G02 <sup>③</sup>	8651C91G07
Lifting yoke	Double standard	8651C91G05	8651C91G08
Lifting yoke	Narrow	8651C91G09	8651C91G10
Lifting yoke	Double narrow	8651C91G15	—
Roll-on-floor lifting device	All	6727D63H20	6727D63H20

<sup>①</sup> Three-pole double-frame breakers have six poles.

<sup>②</sup> Four-pole double-frame breakers have eight poles.

<sup>③</sup> MDSL breakers use lifting yoke 8651C91G04.

**Table 52. Magnum PXR/PD-SB test cabinets**

Description	Style number <sup>①</sup>
Any AC/DC close and trip	9253C25G06
Any AC/DC close, DC trip	9253C25G07
120 Vac close, capacitor trip	9253C25G08
Test cable Magnum PXR/PD-SB	9253C25G05

<sup>①</sup> Contact your local Eaton sales representative to order.

**Table 53. Magnum DS/SB/IEC test cabinets**

Description	Style number
Any AC/DC close and trip	9253C25G01
Any AC/DC close, DC trip	9253C25G02
120 Vac close, capacitor trip	9253C25G03
Test cable Magnum DS/SB/IEC	9253C25G04

## Mechanical interlock configurations

**Table 54. Mechanical interlock configurations—some assembly required**

Type of interlock	Typical circuit	Interlocks possible																								
<b>Type 2</b> <b>Across two circuit breakers</b> One normal power supply and one emergency power supply.		Circuit breaker A can only be closed if B is open and vice versa. A = Normal power supply. B = Emergency power supply. <table border="1"> <thead> <tr> <th>A</th> <th>B</th> </tr> </thead> <tbody> <tr> <td>0</td> <td>0</td> </tr> <tr> <td>1</td> <td>0</td> </tr> <tr> <td>0</td> <td>1</td> </tr> </tbody> </table>	A	B	0	0	1	0	0	1																
A	B																									
0	0																									
1	0																									
0	1																									
<b>Type 31</b> <b>Across three circuit breakers</b> Two normal power supplies and one emergency power supply.		Circuit breaker A and C can only be closed if B is open. B can only be closed when A and C are open. <table border="1"> <thead> <tr> <th>A</th> <th>B</th> <th>C</th> </tr> </thead> <tbody> <tr> <td>0</td> <td>0</td> <td>0</td> </tr> <tr> <td>1</td> <td>0</td> <td>0</td> </tr> <tr> <td>0</td> <td>1</td> <td>0</td> </tr> <tr> <td>0</td> <td>0</td> <td>1</td> </tr> </tbody> </table>	A	B	C	0	0	0	1	0	0	0	1	0	0	0	1									
A	B	C																								
0	0	0																								
1	0	0																								
0	1	0																								
0	0	1																								
<b>Type 32</b> <b>Across three circuit breakers</b> The two half-busbars can be powered by a single transformer (bus-tie closed) or by both at the same time (bus-tie open).		One or two circuit breakers out of three can be closed at the same time. <table border="1"> <thead> <tr> <th>A</th> <th>B</th> <th>C</th> </tr> </thead> <tbody> <tr> <td>0</td> <td>0</td> <td>0</td> </tr> <tr> <td>1</td> <td>0</td> <td>0</td> </tr> <tr> <td>0</td> <td>1</td> <td>0</td> </tr> <tr> <td>0</td> <td>0</td> <td>1</td> </tr> <tr> <td>1</td> <td>1</td> <td>0</td> </tr> <tr> <td>0</td> <td>1</td> <td>1</td> </tr> <tr> <td>1</td> <td>0</td> <td>1</td> </tr> </tbody> </table>	A	B	C	0	0	0	1	0	0	0	1	0	0	0	1	1	1	0	0	1	1	1	0	1
A	B	C																								
0	0	0																								
1	0	0																								
0	1	0																								
0	0	1																								
1	1	0																								
0	1	1																								
1	0	1																								
<b>Type 33</b> <b>Across three circuit breakers</b> Three power supplies (generators or transformers) on the same busbar, making operation in parallel impossible.		Only one of three circuit breakers can be closed. <table border="1"> <thead> <tr> <th>A</th> <th>B</th> <th>C</th> </tr> </thead> <tbody> <tr> <td>0</td> <td>0</td> <td>0</td> </tr> <tr> <td>1</td> <td>0</td> <td>0</td> </tr> <tr> <td>0</td> <td>1</td> <td>0</td> </tr> <tr> <td>0</td> <td>0</td> <td>1</td> </tr> </tbody> </table>	A	B	C	0	0	0	1	0	0	0	1	0	0	0	1									
A	B	C																								
0	0	0																								
1	0	0																								
0	1	0																								
0	0	1																								

## Mechanical interlock accessories

**Table 55. Two-way fixed breakers**

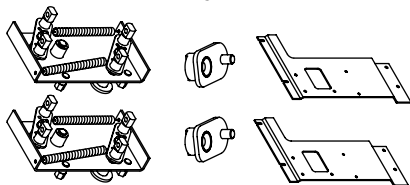

Type	Catalog number
Rod (requires one rod kit)	MI2FR
Cable (requires one cable kit)	MI2FC

**Table 56. Three-way fixed breakers**

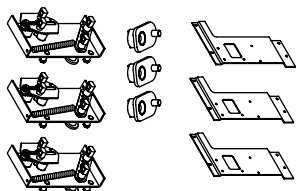

Type	Catalog number
Cable Type 31 (requires two cable kits)	MI31FC
Cable Type 33 (requires three cable kits)	MI33FC

**Table 57. Three-way fixed breakers**

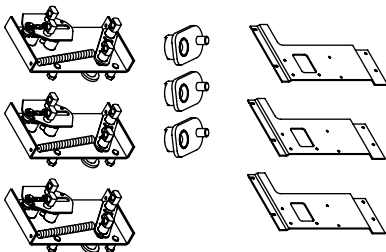

Type	Catalog number
Cable Type 32 (requires three cable kits)	MI32FC

**Table 58. Two-way drawout breakers**

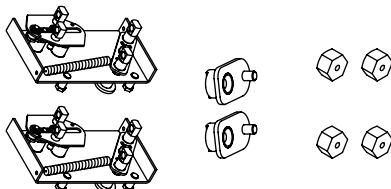

Type	Catalog number
Rod (requires one rod kit)	MI2DR
Cable (requires one cable kit)	MI2DC

**Table 59. Three-way drawout breakers**

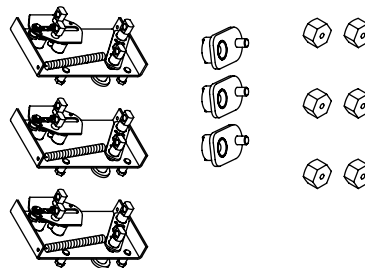

Type	Catalog number
Cable Type 31 (requires two cable kits)	MI31DC
Cable Type 33 (requires three cable kits)	MI33DC

**Table 60. Three-way drawout breakers**

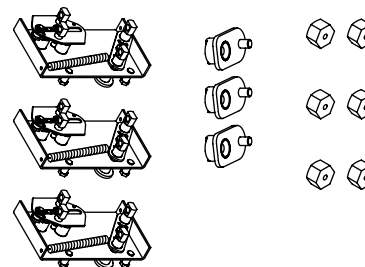

Type	Catalog number
Cable Type 32 (requires three cable kits)	MI32DC

**Table 61. Rod kit**

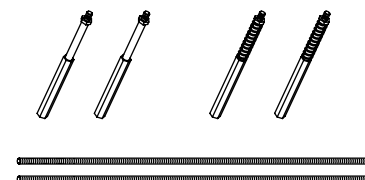

Rod type in feet (m)	Catalog number
Two rods—3 (0.9) each	MIR

**Table 62. Cable kits**

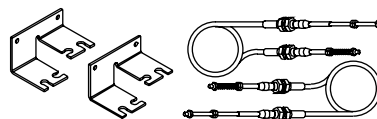

Cable type in feet (m)	Catalog number
Two cables—5 (1.5) each	MIC5
Two cables—6 (1.8) each	MIC6
Two cables—8 (2.4) each	MIC8
Two cables—10 (3.0) each	MIC10

## Standard breaker replacement parts

**Table 63. Magnum PXR/PD-SB breaker front covers** ①②

Frame size	Prefix	Trip unit	Color	Style number	
				Three-pole ③	Four-pole ④
Standard	MPS	PXR 20/25/35	Medium grey	<b>2A11109G02</b>	<b>2A11109G01</b>
Double standard	MPS	PXR 20/25/35	Medium grey	<b>2A11109G04</b>	<b>2A11109G03</b>
Narrow	MPN	PXR 20/25/35	Medium grey	<b>2A11109G06</b>	<b>2A11109G05</b>
Double narrow	MPN	PXR 20/25/35	Medium grey	<b>2A11109G08</b>	<b>2A11109G07</b>
Standard	MPS	None (non-auto)	Medium grey	<b>2A11109G10</b>	<b>2A11109G09</b>
Double standard	MPS	None (non-auto)	Medium grey	<b>2A11109G12</b>	<b>2A11109G11</b>
Narrow	MPN	None (non-auto)	Medium grey	<b>2A11109G14</b>	<b>2A11109G13</b>
Double narrow	MPN	None (non-auto)	Medium grey	<b>2A11109G16</b>	<b>2A11109G15</b>
Standard	SPS	PXR 20/25/35	Light grey	<b>2A11109G18</b>	<b>2A11109G17</b>
Double standard	SPS	PXR 20/25/35	Light grey	<b>2A11109G20</b>	<b>2A11109G19</b>
Narrow	SPN	PXR 20/25/35	Light grey	<b>2A11109G22</b>	<b>2A11109G21</b>
Double narrow	SPN	PXR 20/25/35	Light grey	<b>2A11109G24</b>	<b>2A11109G23</b>

① General order, item, and sequence number must be supplied in the order notes for the proper nameplate to be applied. Includes mounting screws.

② Levering door blank cover for fixed-mounted breakers not included. Refer to **Table 6** for style numbers. Operations counter blank not included.

③ Three-pole double-frame breakers have six poles.

④ Four-pole double-frame breakers have eight poles.

**Table 64. Magnum DS/SB/IEC breaker front covers** ①②

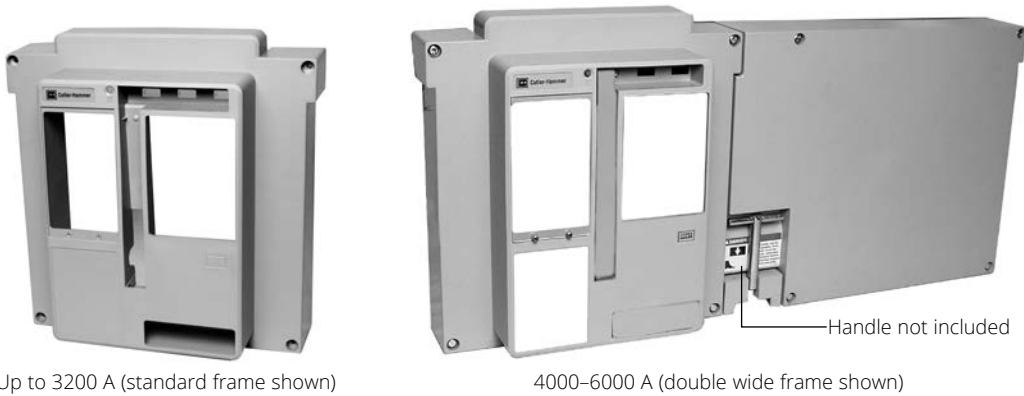

Frame size	Prefix	Continuous ampere rating (A)	Color	Style number	
				Three-pole ③	Four-pole ④
Standard	MDS	Up to 3200	Medium grey	<b>2A11894G06</b>	<b>2A11894G05</b>
Standard	MDSL	Up to 2000	Medium grey	<b>2A11894G33</b>	—
Standard	MDSX	1200–2000	Medium grey	<b>2A11894G29</b>	—
Standard	MDE	Up to 2500	Medium grey	<b>2A11894G06</b>	—
Standard	DAS	1600–3200	Medium grey	<b>2A11894G06</b>	—
Double	MDS	4000–5000	Medium grey	<b>2A11894G08</b>	<b>2A11894G07</b>
Double	MDSX/MDSE/MDDX	2500–5000	Medium grey	<b>2A11894G30</b>	—
Narrow	MDN	Up to 2000	Medium grey	<b>2A11894G16</b>	<b>2A11894G15</b>
Double narrow	MDN	4000–5000	Medium grey	<b>2A11894G27</b>	<b>2A11894G28</b>
Standard	SBS	Up to 3000	Light grey	<b>2A11894G19</b>	<b>2A11894G20</b>
Standard	SBSE	1200–2000	Light grey	<b>2A11894G31</b>	—
Standard	DBS	Up to 3200	Light grey	<b>2A11894G19</b>	—
Double	SBS	4000–5000	Light grey	<b>2A11894G23</b>	<b>2A11894G24</b>
Double	SBSE	2500–5000	Light grey	<b>2A11894G32</b>	—
Narrow	SBN	Up to 2000	Light grey	<b>2A11894G21</b>	<b>2A11894G22</b>
Double narrow	SBN	4000–5000	Light grey	<b>2A11894G25</b>	<b>2A11894G26</b>
Standard	MWI	Up to 4000	Dark grey	<b>2A11894G02</b>	<b>2A11894G01</b>
Standard	DEK/DGK	2500–3200	Dark grey	<b>2A11894G02</b>	—
Double	MWI/DEK/DGK	4000–5000	Dark grey	<b>2A11894G04</b>	<b>2A11894G03</b>
Narrow	MWN	Up to 2000	Dark grey	—	<b>2A11894G11</b>
Narrow	MWN/DEM/DGM	Up to 2000	Dark grey	<b>2A11894G12</b>	—
Double narrow	MWN	4000	Dark grey	<b>2A11894G18</b>	<b>2A11894G17</b>

① General order, item, and sequence number must be supplied in the order notes for the proper nameplate to be applied. Includes mounting screws.

② Clear trip unit cover or non-automatic cover not included. Refer to **Table 88** and **Table 89** for catalog numbers. Levering door blank cover for fixed-mounted breakers not included. Refer to **Table 6** for style numbers.

③ Three-pole double-frame breakers have six poles.

④ Four-pole double-frame breakers have eight poles.

**Table 65. Center pull and charging handle assemblies**

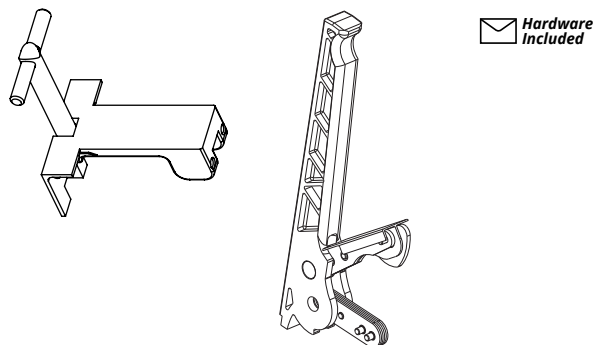

Description	Style number
Pull-out breaker handle for double-standard frame breakers	<b>2A11851G02</b>
Charging handle with stop pawl assembly	<b>2A10892G01</b>

**Table 66. Trip shaft repair**

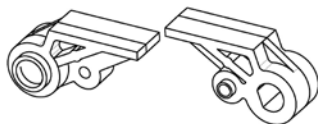

Description	Style number
D-latch trip lever upgrade kit	<b>2A12888G20</b>
Trip shaft repair kit	<b>2A12888G03</b>

**Table 67. Miscellaneous**

Description	Style number
Fixed breaker mounting feet	<b>2A10851G01</b>
Drawout breaker ground contact	<b>1B92611H01</b>
Wire seal	<b>5108A03H01</b>

**Table 68. Arc chutes**



Frame size	AC or DC	Interrupting rating (kA)	Style number	
			Three-pole <sup>①</sup>	Four-pole <sup>②</sup>
Standard and double standard	AC	Up to 130	<b>2A11895G01</b> <sup>③</sup>	<b>2A11895G02</b> <sup>③</sup>
Standard and double standard	AC	150/200 (MDSX)	<b>2A11895G31</b> <sup>③</sup>	—
Standard	AC	200 (MDSL)	<b>2A11895G01</b>	—
Narrow and double narrow	AC	All	<b>2A11895G03</b> <sup>③</sup>	<b>2A11895G04</b> <sup>③</sup>
Standard and double standard	DC (DAS, DBS, DEK)	All	<b>2A11895G01</b> <sup>③</sup>	<b>2A11895G02</b> <sup>③</sup>
Narrow and double narrow	DC (DEM)	All	<b>2A11895G03</b> <sup>③</sup>	<b>2A11895G04</b> <sup>③</sup>
Standard and double standard	DC (DGK)	All	<b>2A11895G05</b>	<b>2A11895G06</b>
Narrow and double narrow	DC (DGM)	All	<b>2A11895G07</b>	<b>2A11895G08</b>

<sup>①</sup> Three-pole double-frame breakers have six poles.

<sup>②</sup> Four-pole double-frame breakers have eight poles.

<sup>③</sup> Quantity of two required for double-frame breakers.

## PXR trip units and related components

Table 69. PXR trip unit field install kits ①



PXR 20 LSI GAM

PXR 25 LSI GAM

PXR trip unit	Functions ②	Communications	Equipped with Arcflash Reduction Maintenance System	13th and 14th digits in breaker catalog number	Catalog number
PXR 20	LSI	Adapter module (CAM)	No	2A	PXR20VN30LNNC
PXR 20	LSIG	Adapter module (CAM)	No	2C	PXR20VN30LGNC
PXR 20	LSI	Modbus RTU and CAM	Yes	2H	PXR20VN30LNAM
PXR 20	LSIG	Modbus RTU and CAM	Yes	2F	PXR20VN30LGAM
PXR 25	LSI	Modbus RTU and CAM	Yes	2Q	PXR25VN30LNAM
PXR 25	LSIG	Modbus RTU and CAM	Yes	2S	PXR25VN30LGAM

① To change the  $I_n$  rating, order the digital continuous current rating change license (PXM-PXR-RATING) available from [www.eaton.com/pxpm](http://www.eaton.com/pxpm) and label kit PXRIN-LABEL-KIT.

② Refer to Table 70 for details on the trip unit functions.

Table 70. Trip unit functions

Symbol	Meaning
L	Long time trip (overload)
S	Short time trip
I	Instantaneous trip
G	Ground (Earth) fault trip

Table 71. PXR neutral sensors ①



Description	Style number
Iron-core CT (window type) neutral sensor	MSCNCT ②
Rogowski (busbar type) neutral sensor	NRMPN ③

① For use with PXR trip units only.

② Double-frame breakers can use one or two CT type neutral sensors depending on application requirements.

③ All frames use one Rogowski type neutral sensor.

Table 72. Voltage sensing module (VDB) ①

Description	Catalog number
PXR 25 voltage sensing module	MVTGDB

① For use with PXR 25 trip units only.

Table 73. PXR trip unit covers and labels ①

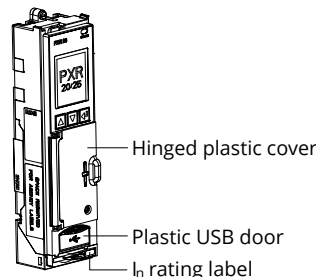

Description	Catalog number
PXR 20/25 trip unit hinged plastic cover	MPXRPC
PXR 20/25 trip unit plastic USB door	MPXRPD
$I_n$ rating label kit	PXRIN-LABEL-KIT

① For use with PXR trip units only.

Table 74. PXR communications accessories ①



Description	Catalog number
Modbus TCP/IP communication adapter module	PXR-ECAM-MTCP
PROFIBUS communication adapter module	PXR-PCAM

① For use with PXR 20/25 trip units only.

## Digitrip trip units and related components

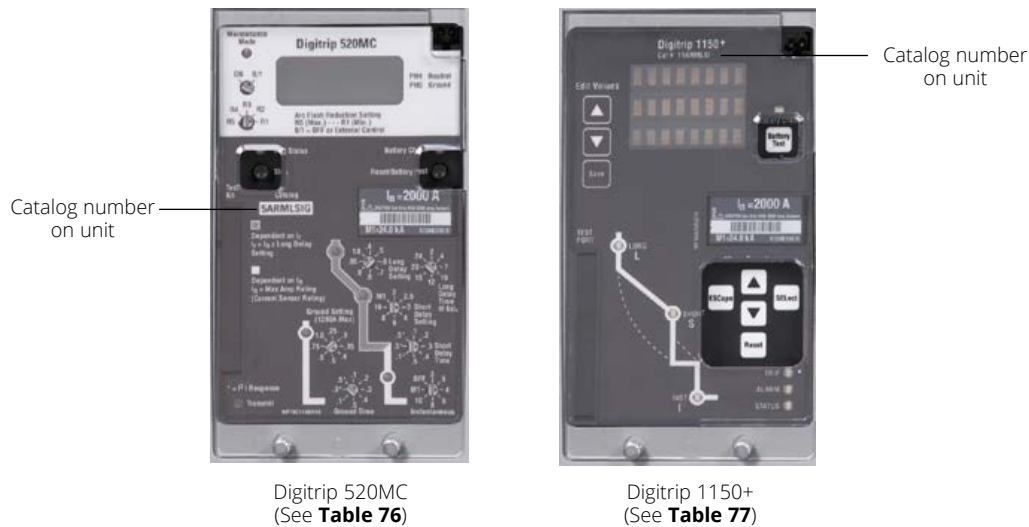

**Table 75. Digitrip 520M trip unit field install kits**

Digitrip	Functions <sup>①</sup>	Communications	Equipped with Arcflash Reduction Maintenance System	Catalog number on unit <sup>②</sup>	Style number
520M	LSI	—	No	5MLSI	2A11799G20
520M	LSIG	—	No	5MLSIG	2A11799G21

<sup>①</sup> Refer to **Table 80** for details on the trip unit functions.

<sup>②</sup> The catalog number on the trip unit cannot be used for ordering. Use the corresponding style number.

**Table 76. Digitrip 520MC trip unit field install kits**

Digitrip	Functions <sup>①</sup>	Communications	Equipped with Arcflash Reduction Maintenance System	Catalog number on unit <sup>②</sup>	Style number
520MC	LSI	INCOM	Yes	5ARMLSI	2A11799G34 <sup>③</sup>
520MC	LSIG	INCOM	Yes	5ARMLSIG	2A11799G35 <sup>③</sup>

<sup>①</sup> Refer to **Table 80** for details on the trip unit functions.

<sup>②</sup> The catalog number on the trip unit cannot be used for ordering. Use the corresponding style number.

<sup>③</sup> Does not replace a Digitrip without Arcflash Reduction Maintenance System. Contact Eaton for upgrade kits.

**Table 77. Digitrip 1150+ trip unit field install kits**

Digitrip	Functions <sup>①</sup>	Communications	Equipped with Arcflash Reduction Maintenance System	Catalog number on unit <sup>②</sup>	Style number
1150+	LSI	INCOM	Yes	11ARMLSI	2A11799G51
1150+	LSIG	INCOM	Yes	11ARMLSIG	2A11799G52

<sup>①</sup> Refer to **Table 80** for details on the trip unit functions.

<sup>②</sup> The catalog number on the trip unit cannot be used for ordering. Use the corresponding style number.

**Table 78. IEC Digitrip 520Mi trip unit field install kits**

Digitrip	Functions <sup>①</sup>	Communications	Equipped with Arcflash Reduction Maintenance System	Catalog number on unit <sup>②</sup>	Style number
520Mi	LSIG	—	No	5MWLSIG	2A11799G22

<sup>①</sup> Refer to **Table 80** for details on the trip unit functions.

<sup>②</sup> The catalog number on the trip unit cannot be used for ordering. Use the corresponding style number.

**Table 79. IEC Digitrip 1150i trip unit field install kits**

Digitrip	Functions ①	Communications	Equipped with Arcflash Reduction Maintenance System	Catalog number on unit ②	Style number
1150i	LSI	INCOM	Yes	11ARMIEC	2A11799G54
1150i	LSIG/LSIA	INCOM	Yes	11ARMIECEF	2A11799G55

① Refer to **Table 80** for details on the trip unit functions.

② The catalog number on the trip unit cannot be used for ordering. Use the corresponding style number.

**Table 80. Trip unit functions**

Symbol	Meaning
L	Long time trip (overload)
S	Short time trip
I	Instantaneous trip
G	Ground (earth) fault trip
A	Ground (earth) fault alarm

**Table 81. 520M and 520MC ground (earth) fault alarm/power relay module (automatic trip relay) ①②**



Description	Voltage	Catalog/ style number
520M/520MC power relay module	24/48 Vdc	MPRMH
520M/520MC power relay module	120 Vac	MPRMA
520M/520MC power relay module	240 Vac	MPRMR
520M/520MC power relay module	125 Vdc	70C1081G04

① For use with Digitrip 520M, 520MC, 520Mi, and 520MCi trip units only.

② Includes required wiring harnesses for control power, Arcflash Reduction Maintenance System, and relay connections.

**Table 82. 1150 power relay module (automatic trip relay) ①**



Description	Voltage	Style number
1150/1150+ power relay module	24/48 Vdc	2A11772G11
1150/1150+ power relay module	120 Vac	2A11772G12
1150/1150+ power relay module	240 Vac	2A11772G13
1150/1150+ power relay module	125 Vdc	2A11772G14

① For use with Digitrip 1150, 1150+, 1150i trip units only.

**Table 83. Auxiliary power module ①**



Description	Catalog number
120–240 Vac input 50/60 Hz—32 Vdc output	PRTBAPMDV

① For use with Digitrip trip units only.

**Table 84. Current sensors (CTs) and rating plugs for 520/520M/520MC/1150 trip units** ①②③④



Sensor and rating plug (I <sub>n</sub> ) ampere rating (A)	Number of poles	Number of sensors	Narrow frame	Standard frame	Double-narrow frame	Double-standard frame	IEC 4000 A standard frame
200	3	3	M3NRG0200	M3SRG0200	—	—	—
250	3	3	M3NRG0250	M3SRG0250	—	—	—
300	3	3	M3NRG0300	M3SRG0300	—	—	—
400	3	3	M3NRG0400	M3SRG0400	—	—	—
600	3	3	M3NRG0600	M3SRG0600	—	—	—
630	3	3	M3NRG0630	M3SRG0630	—	—	—
800	3	3	M3NRG0800	M3SRG0800	—	—	—
1000	3	3	M3NRG1000	M3SRG1000	—	—	—
1200	3	3	M3NRG1200	M3SRG1200	—	—	—
1250	3	3	M3NRG1250	M3SRG1250	—	—	—
1600	3	3	M3NRG1600	M3SRG1600	—	—	—
2000	3	3 or 6 ⑤	M3NRG2000	M3SRG2000	M3DNG2000	M3RRG2000	M3ERG2000 ⑦
2500	3	3 or 6 ⑤	—	M3SRG2500	M3DNG2500	M3RRG2500	M3ERG2500 ⑦
3000	3	3	—	M3SRG3000	—	—	M3ERG3000 ⑦
3200	3	3 or 6 ⑤	—	M3SRG3200	M3DNG3200	M3RRG3200	M3ERG3200 ⑦
4000	3	3 or 6 ⑤	—	—	M3DNG4000	M3RRG4000	M3ERG4000 ⑦
5000	3	6	—	—	M3DNG5000	M3RRG5000	—
6000	3	6	—	—	—	M3RRG6000	—
6300	3	6	—	—	—	M3RRG6300 ⑦	—
200	4	4	M4NRG0200	M4SRG0200	—	—	—
250	4	4	M4NRG0250	M4SRG0250	—	—	—
300	4	4	M4NRG0300	M4SRG0300	—	—	—
400	4	4	M4NRG0400	M4SRG0400	—	—	—
600	4	4	M4NRG0600	M4SRG0600	—	—	—
630	4	4	M4NRG0630	M4SRG0630	—	—	—
800	4	4	M4NRG0800	M4SRG0800	—	—	—
1000	4	4	M4NRG1000	M4SRG1000	—	—	—
1200	4	4	M4NRG1200	M4SRG1200	—	—	—
1250	4	4	M4NRG1250	M4SRG1250	—	—	—
1600	4	4	M4NRG1600	M4SRG1600	—	—	—
2000	4	4 or 8 ⑥	M4NRG2000	M4SRG2000	M4DNG2000	M4RRG2000	M4ERG2000 ⑦
2500	4	4 or 8 ⑥	—	M4SRG2500	M4DNG2500	M4RRG2500	M4ERG2500 ⑦
3000	4	4	—	M4SRG3000	—	—	M4ERG3000 ⑦
3200	4	4 or 8 ⑥	—	M4SRG3200	M4DNG3200	M4RRG3200	M4ERG3200 ⑦
4000	4	4 or 8 ⑥	—	—	M4DNG4000	M4RRG4000	M4ERG4000 ⑦
5000	4	8	—	—	M4DNG5000	M4RRG5000	—
6000	4	8	—	—	—	M4RRG6000	—
6300	4	8	—	—	—	M4RRG6300 ⑦	—

① For use with Digitrip trip units only.

② Each kit includes one rating plug.

③ Sensor/rating plug size cannot exceed breaker frame rating.

④ If there is a neutral sensor, it needs to match the breaker sensors. Refer to **Table 86**.

⑤ Standard and narrow-frame kits include three sensors; double-standard and double-narrow frame kits include six sensors.

⑥ Standard and narrow-frame kits include four sensors; double-standard and double-narrow frame kits include eight sensors.

⑦ IEC only.

**Table 85. Rating plugs only** ①



Rating plug ampere rating (A)	Frame size	Style number
200	Narrow, standard	<b>2A11891G01</b>
250	Narrow, standard	<b>2A11891G02</b>
300	Narrow, standard	<b>2A11891G03</b>
400	Narrow, standard	<b>2A11891G04</b>
600	Narrow, standard	<b>2A11891G05</b>
630	Narrow, standard	<b>2A11891G06</b>
800	Narrow, standard	<b>2A11891G07</b>
1000	Narrow, standard	<b>2A11891G08</b>
1200	Narrow, standard	<b>2A11891G09</b>
1250	Narrow, standard	<b>2A11891G10</b>
1600	Narrow, standard	<b>2A11891G11</b>
2000	Narrow, standard	<b>2A11891G12</b>
2500	Standard	<b>2A11891G13</b>
3000	Standard	<b>2A11891G14</b>
3200	Standard	<b>2A11891G15</b>
2000	Double narrow, double standard	<b>2A11891G16</b>
2500	Double narrow, double standard	<b>2A11891G17</b>
3200	Double narrow, double standard	<b>2A11891G18</b>
4000	Double narrow, double standard	<b>2A11891G19</b>
5000	Double narrow, double standard	<b>2A11891G20</b>
6000	Double standard	<b>2A11891G23</b>
6300	Double standard ②	<b>2A11891G21</b>

① For use with Digitrip trip units only.

② IEC only.

**Table 86. Digitrip neutral sensors** ①②



Description	Style number
Digitrip neutral sensor—200 A	<b>9253C03H01</b>
Digitrip neutral sensor—250 A	<b>9253C03H02</b>
Digitrip neutral sensor—300 A	<b>9253C03H03</b>
Digitrip neutral sensor—400 A	<b>9253C03H04</b>
Digitrip neutral sensor—600 A	<b>9253C03H05</b>
Digitrip neutral sensor—630 A	<b>9253C03H14</b>
Digitrip neutral sensor—800 A	<b>9253C03H06</b>
Digitrip neutral sensor—1000 A	<b>9253C03H07</b>
Digitrip neutral sensor—1200 A	<b>9253C03H08</b>
Digitrip neutral sensor—1250 A	<b>9253C03H15</b>
Digitrip neutral sensor—1600 A	<b>9253C03H09</b>
Digitrip neutral sensor—2000 A	<b>9253C03H10</b>
Digitrip neutral sensor—2500 A	<b>9253C03H11</b>
Digitrip neutral sensor—3000 A	<b>9253C03H12</b>
Digitrip neutral sensor—3200 A	<b>9253C03H13</b>

① For use with Digitrip trip units only.

② Double-frame breakers require quantity of two neutral sensors where the rating is equal to half of the  $I_n$  rating listed on the rating plug.

**Table 87. Digitrip 1150 PT module parts** ①

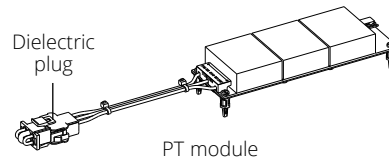

Description	Style number
PT module replacement	<b>2A11772G01</b>
PT module dielectric plug	<b>5723B50G41</b>
Reverse-feed metering kit	<b>2A10726G01</b>

① For use with Digitrip 1150, 1150+, 1150i/ trip units only.

**Table 88. Digitrip covers** ①

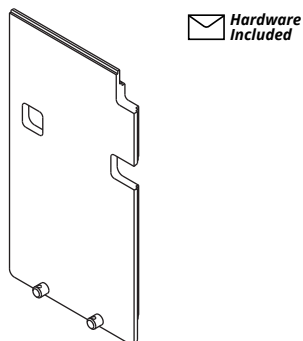

Digitrip type	Catalog number
520/520M/520MC	<b>M220520CVR</b>
1150/1150+/1150i	<b>M1150CVR</b>

① For use with Digitrip trip units only.

**Table 89. Non-automatic Digitrip covers**

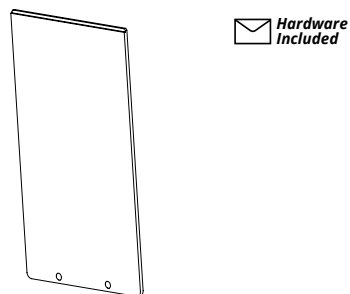

Breaker type	Color	Catalog number
Magnum DS (MDS/MDN)	Medium grey	<b>MTUNACA</b>
Magnum IEC (MWI/MWN)	Dark grey	<b>MTUNACI</b>

**Table 90. Digitrip mounting deck** ①

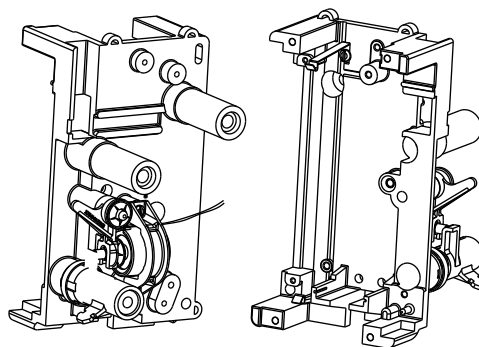

Digitrip type	Frame size	Current rating (A)	Interrupting rating (kA)	Style number
520/520M/520MC	Narrow	800–2000	Up to 100	<b>2A11898G01</b>
520/520M/520MC	Double narrow	4000–5000	Up to 100	<b>2A11898G01</b>
520/520M/520MC	Standard	800–4000	Up to 85	<b>2A11898G01</b>
520/520M/520MC	Standard	800–4000	100, 130, 200 (MDSX)	<b>2A11898G04</b>
520/520M/520MC	Standard	800–2000	200 (MDSL)	<b>6D33491G07</b>
520/520M/520MC	Double standard	4000–5000	Up to 130	<b>2A11898G01</b>
520/520M/520MC	Double standard	4000–5000	150 (MDSE, SBSE), 200 (MDSX, MDDX)	<b>2A11898G04</b>
520/520M/520MC	Double standard	6000–6300	Up to 100	<b>2A11898G05</b>
1150/1150+/1150i	Narrow	800–2000	Up to 100	<b>6D33491G66</b>
1150/1150+/1150i	Double narrow	4000–5000	Up to 100	<b>6D33491G66</b>
1150/1150+/1150i	Standard	800–4000	Up to 85	<b>2A11898G11</b>
1150/1150+/1150i	Standard	800–4000	100, 130, 200 (MDSX)	<b>2A11898G14</b>
1150/1150+/1150i	Standard	800–2000	200 (MDSL)	<b>6D33491G17</b>
1150/1150+/1150i	Double standard	4000–5000	Up to 130	<b>2A11898G11</b>
1150/1150+/1150i	Double standard	4000–5000	150 (MDSE, SBSE), 200 (MDSX, MDDX)	<b>2A11898G14</b>
1150/1150+/1150i	Double standard	6000–6300	Up to 100	<b>2A11898G15</b>
None (non-auto)	All	All	All	<b>2A11898G03</b>

① For use with Digitrip trip units only.

**Table 91. Digitrip direct trip actuators (DTA) ①**

Description	Style number
Digitrip DTA	1B92793G01
Digitrip DTA for use with high instantaneous module	1B92793G04

① For use with Digitrip trip units only.

**Table 92. Digitrip 520MC Arcflash Reduction Maintenance System wire harnesses ①**

Description	Style number
Magnum DS (except MDN 100 kA)	2A10493G17
Magnum SB and MDN 100 kA	2A10493G18

① For use with Digitrip 520MC trip units with ground alarm/power supplies from 2006 or newer only. If the ground alarm/power supply is pre-2006, a full ground alarm/power supply kit is required (Table 81).

**Table 93. Digitrip test and communications accessories ①**



Description	Catalog number
Functional test kit (handheld trip unit tester)	MTST230V
Trip link cable (used with 1150/1150+/1150/ trip units)	TRIPLINK
Digital relay module (used with 1150/1150+/1150/ trip units)	DRAM
Modbus mMINT translator module (translates INCOM to Modbus RTU)	MMINT

① For use with Digitrip trip units only.

**Table 94. Magnum DS/SB/IEC current sensor door**

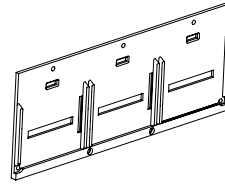

Hardware Included

Frame size	Breaker continuous ampere rating (A)	Style number	
		Three-pole ①	Four-pole ②
Standard	800–2000	2A10853G04	2A10853G03
Standard	2500–3200	2A10853G02	2A10853G01
Double standard	4000–6000	2A10853G02 ③	2A10853G01 ③
Narrow	800–2000	2A10853G05	2A10853G06
Double narrow	4000–5000	2A10853G04 ③	2A10853G03 ③

① Three-pole double-frame breakers have six poles.

② Four-pole double frame breakers have eight poles.

③ Quantity of two required for double-frame breakers.

This page intentionally left blank.

**Eaton**  
1000 Eaton Boulevard  
Cleveland, OH 44122  
United States  
Eaton.com

©2025 Eaton  
All Rights Reserved  
Printed in USA  
Publication No. TD013013EN / Z30133  
March 2025

For more information, visit  
**Eaton.com/magnum**

Eaton is a registered trademark.

All other trademarks are property  
of their respective owners.