

Surge Protection



Powering Business Worldwide



We make what matters work.*



At Eaton, we believe that power is a fundamental part of just about everything people do. That's why we're dedicated to helping our customers find new ways to manage electrical, hydraulic and mechanical power more efficiently, safely and sustainably. To improve people's lives, the communities where we live and work, and the planet our future generations depend upon. Because this is what really matters. And we're here to make sure it works.

To learn more go to: [Eaton.com/whatmatters](https://www.eaton.com/whatmatters)

EATON

Powering Business Worldwide

We make what matters work.

EATON CORPORATION CA010001EN

Surge Protection

Combined class 1/2/3 tested SPD without fused supply for 40 mm busbar, SPZ01

Accessories fitting the SPZT-S within the ZSD enclosure family11

Combined class 1/2 tested SPD , SPH15

Combined class 1/2 tested SPD, SPB20

Class 2 tested SPD, SPCT226

Test class 3 tested SPD, SPDT3.....39

Busbar42

DC SPDs for photovoltaic systems44

Class 1 and 2 combined tested DC SPDs for photovoltaic systems45

2 MPPT DC SPDs for photovoltaic systems.....52

Class 2 tested DC SPDs for photovoltaic systems55

Type Overview

SP B T12 - 280 - 3+NPE / BB

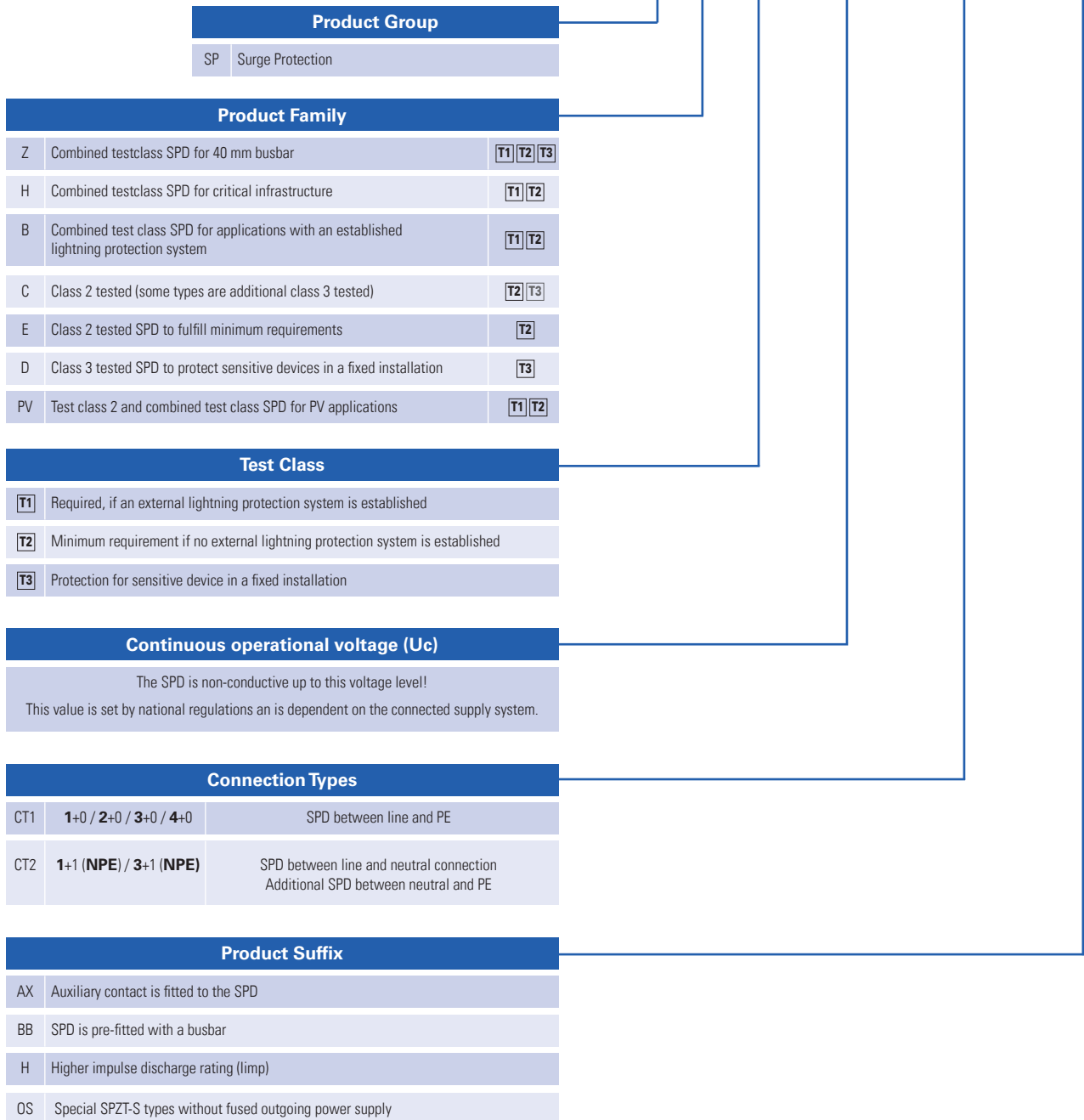

Connection of SPDs

Connection Type 1 (CT1)

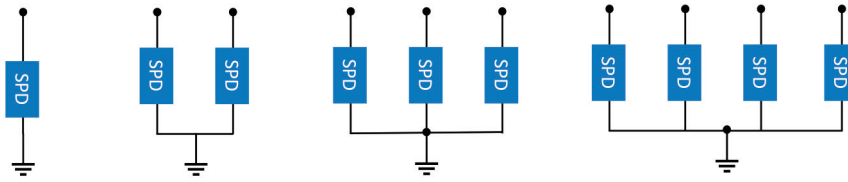

SPD between every live connection and earth potential!

- To be fitted in-front of an RCD
- The „3+0“ connection is used in TN-C and TN-C-S systems (if the PEN connection is established within 0.5 m)
- 2+0 / 4+0 connections are used in TN-S systems, given that no RCD is in-front of the SPD

Connection Type 2 (CT2)

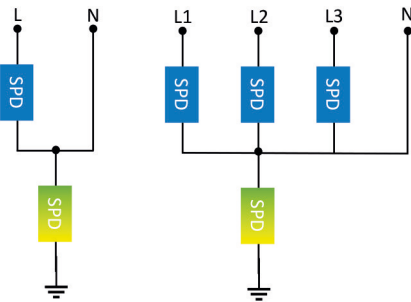

An additional SPD is installed between neutral and protective earth (galvanic separation is ensured).

- Can be installed behind an RCD (various conditions need to be met)
- 1+1 connection suited for TN-C-S and TT networks (single phase)
- 3+1 suited for TN-C-S and TT systems (three phase)
- Easy application due to the possibility to be fitted in front or after an RCD (dependent on supply network, test class and type of RCD)

Connection of an SPD after an RCD

- It is not recommended (or forbidden by local regulations) to install a test class 1 tested SPD after an RCD
- The minimum surge current capabilities for an RCD in-front of an SPD shall be 3 kA (established by type S/G/F/B RCDs)
- Please be aware that even a surge current proof RCD can trip if an SPD is placed in series
- Connecting neutral and protective Earth behind an RCD is forbidden. Galvanic separation is needed (1+1/3+1 connection)

Installation of an SPD

Cross-section of the connected cables

Class 1 tested / class 1 and 2 tested SPDs

- At least **16 mm²** to earth potential
- Possibility to be reduced to 6 mm²*

Class 2 tested SPDs

- At least **6 mm²** to earth potential
- Possibility to be reduced to 2 mm²*

* IEC-60364-4-43 allows a smaller cross-section, if the installation is performed in such a way, that damages due to short circuits are minimized

Cable length

The complete length of connecting cables shall not exceed 0.5 m!

If this is not possible:

- The installed SPD shall provide a sufficient voltage protection level (lower than the minimum required protection level for the installation)
- Installation of a second coordinated SPD which then fulfills the needed voltage protection level of the installation.

Max. back-up fuse

- Every SPD shall have back-up protection
- The back-up fuse shall establish a safe state of the installation after an SPD fails/reaches it's end of life
- This protection device shall be capable of handling the short circuit of the installation
- The internal resistance of the protection device influences the voltage protection level and shall be chosen accordingly

Endurance of an SPD

Every SPD has endurance capabilities which rely on following factors:

- Amount of discharges
- Amplitude of discharges
- Duration/waveform of discharges

A higher I_{max} value can therefore offer a prolonged endurance of an SPD in an installation

Possible failure modes of SPDs

- High impedance fault, where the disconnection is done by the SPD itself.
- Low impedance failure, which requires the back-up protection to disconnect the SPD from the installation
- Interchanging fault

It should be noted, that the mode of disconnection of the SPD depends on the behaviour at it's end of life.

WA_REN_SG_00422



Description

- Combined class 1/2/3 tested SPD
- Intended to be used within meter boards according to VDE 0100-443/-534
- Narrowest design with highest functionality for the 40 mm busbar in only 2 modular units
- To be placed in an Eaton ZSD for a complete solution

Types

SPZ „H“

- Higher limp rating of 12.5 kA
- To be used in applications with an external lightning protection system (LPS III/IV)

SPZ „NPE“

- Suitable for TT and TN-S systems due to the 3+1 connection
- Also available as “H” types with higher limp rating

SPZ „OS“

- SPD without fused outgoing supply
- “H”-Types offer improved impulse surge capabilities limp of 12.5 kA

Surge Protection SPZT123 Slim - without fuse (S-OS)

The SPZT123 surge protection from Eaton is intended in particular for installations in buildings in accordance with VDE 0100-443/-534. The installation is plug-in on the 40 mm busbar of the meter distribution board in the mains-side connection compartment (NAR). Neither screws nor tools are required for installation. A corresponding housing design prevents incorrect positioning and automatically adapts to the 5 mm or 10 mm busbar.

Poles Type	Max. Continuous Operating Voltage U_c	Type Designation	Article No.	Units per package
------------	--	---------------------	-------------	----------------------

Combined Surge Protective Device SPZT123-300/3+NPE-(H)-S-OS

- for TT /TN-S

WA_REN_SG_00422



3pole+NPE	300 VAC	SPZT123-300/3+NPE-S-OS	EP-501041	1
		SPZT123-300/3+NPE-H-S-OS	EP-501042	1

Description Surge Protective Class T1/T2/T3 for Busbar mounting (40 mm), SPZT123-300/3+NPE(-H)-S-

- Ready-to-connect Combined Surge Protection Device Type 1/2/3 on the basis of hybrid arrester
- For mounting on 40 mm busbar
- Field of application:
 - For the protection of low voltage distribution systems against transient overvoltage caused by direct and indirect lightning stroke and switching operations
- Lightning protection classes III and IV according to IEC 62305
- Meets all requirements for installing surge protection according to DIN VDE 0100-534
- For TT & TN-S grid type

Technical Data**OS**

		SPZT123-300/3+NPE-S-OS	SPZT123-300/3+NPE-H-S-OS
General data			
Standards/regulations		IEC 61643-11 2011, EN 61643-11: 2012+A11: 2018	IEC 61643-11 2011, EN 61643-11: 2012+A11: 2018
IEC-Testklassifizierung		$\overline{T1} / \overline{T2} / \overline{T3}$	$\overline{T1} / \overline{T2} / \overline{T3}$
EN type		T1 / T2 / T3	T1 / T2 / T3
Number of ports		1	1
SPD design		Hybrid	Hybrid
Mode of protection		L-N, N-PE	L-N, N-PE
Mounting type		40 mm busbar	40 mm busbar
Surge protection fault message		visual	visual
Color		Light grey RAL 7035	Light grey RAL 7035
Housing material		Thermoplastic	Thermoplastic
Flammability rating according to UL 94		V-0	V-0
Degree of protection		IP20 / IP40 in combination with cover	IP20 / IP40 in combination with cover
Ambient temperature (operation)		-40 °C ... 85 °C	-40 °C ... 85 °C
Ambient temperature (storage/transport)		-40 °C ... 85 °C	-40 °C ... 85 °C
Permissible humidity (operation)		5 % ... 95 %	5 % ... 95 %
Altitude		≤ 4000 m (amsl (above mean sea level))	≤ 4000 m (amsl (above mean sea level))
Width		38 mm	38 mm
Height		233.4 mm	234.4 mm
Depth		102.3 mm	102.3 mm
Horizontal pitch (inkl. 5 mm)		2 Module units	2 Module units
Electrical data			
Nominal voltage AC		U_0 / U_N 240 V	240 V
Maximum continuous operating voltage	L-N	U_C 300 V AC	300 V AC
	N-PE	U_C 305 V AC	305 V AC
Max. discharge current (8/20) μ s	L-N / N-PE	I_{max} 40 kA / 100 kA	40 kA / 100 kA
Nominal discharge current (8/20) μ s	L-N / N-PE	I_n 20 kA / 80 kA	20 kA / 80 kA
Impulse current (10/350) μ s	L-N / N-PE	I_{imp} 7.5 kA / 30 kA	12.5 kA / 50 kA
Short-circuit current rating (AC)	L-N / N-PE	I_{SCCR} 25 kA	25 kA
Open Circuit Voltage of Combination Wave Generator		U_{OC} 6 kV	6 kV
Voltage protection level	L-N / N-PE	U_p 1500 V / 1500 V	1500 V / 1500 V
Follow Current Interrupt Rating	N-PE	I_{fi} 100 A _{RMS}	100 A _{RMS}
Responding time	L-N / N-PE	t_a < 100 ns / < 100 ns	< 100 ns / < 100 ns
Overcurrent protection (max)		315 A gG	160 A gG
TOV Withstand 120 min.	L-N	U_T 442 V	442 V
TOV Withstand 200 ms	N-PE	U_T 1200 V	1200 V
Number of ports		1	1
Leakage current		I_{PE} ≤ 5 μ A	≤ 5 μ A
Connection data			
Connection method		Screw terminal blocks	Screw terminal blocks
Conductor cross section (max.)			
solid, stranded		35 mm ²	35 mm ²
flexible		25 mm ²	25 mm ²
Stripping length		18 mm	18 mm
Tightening torque		4.5 Nm	4.5 Nm

1.4

Surge Protection

xPole

Combined class 1/2/3 tested SPD without fused supply for 40 mm busbar, SPZ

Connection diagram

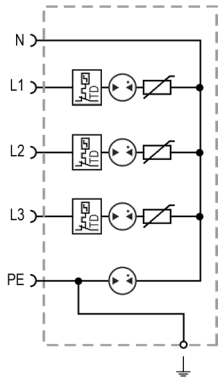

Dimensions (mm)

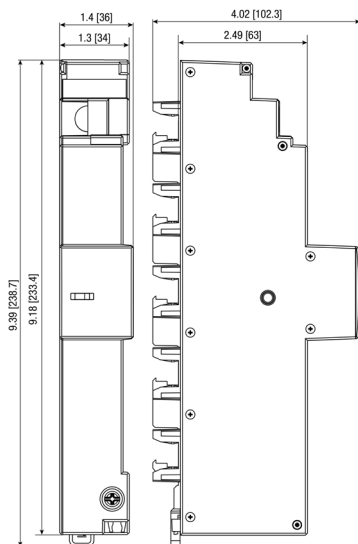

WA_REN_SG_00122



Description

- Combined class 1/2/3 tested SPD
- Intended to be used within meter boards according to VDE 0100-443/-534
- Fulfils the requirement of VDE-AR-N 4100 Chapter 7.8.2 for the power supply of an intelligent metering device from the mains-side connection compartment (NAR)
- Narrowest design with highest functionality for the 40 mm busbar in only 2 modular units
- To be placed in an Eaton ZSD for a complete solution

Types

SPZ „H“

- Higher limp rating of 12.5 kA
- To be used in applications with an external lightning protection system (LPS III/IV)

SPZ „NPE“

- Suitable for TT and TN-S systems due to the 3+1 connection
- Also available as “H” types with higher limp rating

Surge Protection SPZT123 Slim - with fuse

The SPZT123 surge protection from Eaton is particularly intended for installations in buildings in accordance with VDE 0100-443/-534. It can be plugged into the 40 mm busbar of the meter distribution board (ZSD). The innovative phase tap saves costs and space: The SPZT123 can provide the power supply for a gateway and the APZ space via its phase tap without the need for an extra extension of the busbar system for a separate phase tap. Neither screws nor tools are required for installation. An appropriate housing design prevents incorrect positioning and automatically adapts to the 5 mm or 10 mm busbar.

Poles Type	Max. Continuous Operating Voltage U_c	Type Designation	Article No.	Units per package
------------	--	---------------------	-------------	----------------------

Combined Surge Protective Device SPZT123-300/3+NPE-(H)-S

- for TT /TN-S

WA_REN_SG_00122



3pole+NPE	300 VAC	SPZT123-300/3+NPE-S	EP-501043	1
		SPZT123-300/3+NPE-H-S	EP-501044	1

Combined Surge Protective Device SPZT123-300-(H)-S

- for TN-C

WA_REN_SG_00522



3pole	300 VAC	SPZT123-300/3-S	EP-501045	1
		SPZT123-300/3-H-S	EP-501046	1

Description Surge Protective Class T1/T2/T3 for Busbar mounting (40 mm), SPZT123-300-(H)-S

- Ready-to-connect Combined Surge Protection Device Type 1/2/3 on the basis of hybrid arrester
- Field of application:
For the protection of low voltage distribution systems against transient overvoltage caused by direct and indirect lightning stroke and switching operations
- Lightning protection classes III and IV according to IEC 62305
- Meets all requirements for installing surge protection according to DIN VDE 0100-534
- For TN-C grid type

Technical Data

	SPZT123-300/3-S	SPZT123-300/3-H-S
General data		
Standards/regulations	IEC 61643-11 2011, EN 61643-11: 2012+A11: 2018	IEC 61643-11 2011, EN 61643-11: 2012+A11: 2018
IEC-Testklassifizierung	T1 / T2 / T3	T1 / T2 / T3
EN type	T1 / T2 / T3	T1 / T2 / T3
Number of ports	1	1
SPD design	Hybrid	Hybrid
Mode of protection	L-PEN	L-PEN
Mounting type	40 mm busbar	40 mm busbar
Surge protection fault message	visual	visual
Color	Light grey RAL 7035	Light grey RAL 7035
Housing material	Thermoplastic	Thermoplastic
Flammability rating according to UL 94	V-0	V-0
Degree of protection	IP20 / IP40 in combination with cover	IP20 / IP40 in combination with cover
Ambient temperature (operation)	-40 °C ... 85 °C	-40 °C ... 85 °C
Ambient temperature (storage/transport)	-40 °C ... 85 °C	-40 °C ... 85 °C
Permissible humidity (operation)	5 % ... 95 %	5 % ... 95 %
Altitude	≤ 4000 m (amsl (above mean sea level))	≤ 4000 m (amsl (above mean sea level))
Width	36 mm	36 mm
Height	233.4 mm	233.4 mm
Depth	102.3 mm	102.3 mm
Horizontal pitch (incl. 5 mm)	2 Module units	2 Module units
Electrical data		
Nominal voltage AC	U_o / U_N 240 V	240 V
Maximum continuous operating voltage	U_C 300 V AC	300 V AC
Max. discharge current (8/20) μ s	I_{max} 50 kA	50 kA
Nominal discharge current (8/20) μ s	I_n 40 kA	40 kA
Impulse current (10/350) μ s	I_{imp} 7.5 kA	12.5 kA
Short-circuit current rating (AC)	I_{SCCR} 25 kA	25 kA
Open Circuit Voltage of Combination Wave Generator	U_{OC} 6 kV	6 kV
Voltage protection level	U_p 1500 V	1500 V
Responding time	t_a < 100 ns	< 100 ns
TOV behavior at U_T	442 V	442 V
Max. backup fuse	160 A (gG)	160 A (gG)
Number of ports	1	1

1.8

Surge Protection

xPole

Combined class 1/2/3 tested SPD with a fused supply for 40 mm busbar, SPZ

	SPZT123-300/3-S	SPZT123-300/3-H-S
Technical Data		
Connection method	Screw terminal blocks	Screw terminal blocks
Conductor cross section (max.)		
solid, stranded	2 AWG, 35 mm ²	2 AWG, 35 mm ²
flexible	4 AWG, 25 mm ²	4 AWG, 25 mm ²
Stripping length	18 mm	18 mm
Tightening torque	4.5 Nm	4.5 Nm
Additional supply terminal (LA)		
Rated current integrierter Abgang	I _n 6.3 A	6.3 A
Back-up fuse 5 x 20 mm	FF 6.3 A	6.3 A
Wire connection method	2x Push-In	2x Push-In
Conductor cross section (max.)		
solid, stranded, flexible	14 AWG, 2.5 mm ²	14 AWG, 2.5 mm ²

Connection diagram

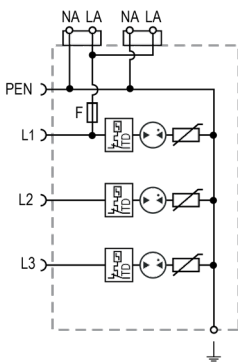

Dimensions (mm)

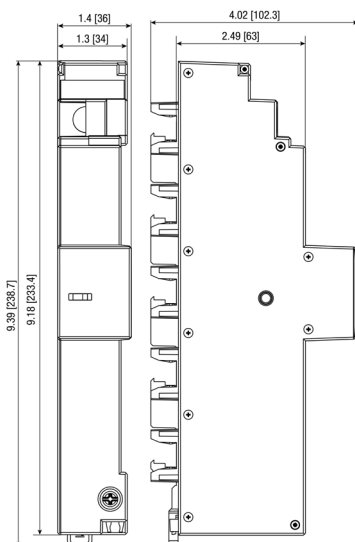

Description Surge Protective Class T1/T2/T3 for Busbar mounting (40 mm), SPZT123-300/3+NPE(-H)-S-OS

- Ready-to-connect Combined Surge Protection Device Type 1/2/3 on the basis of hybrid arrester
- For mounting on 40 mm busbar
- Field of application:
For the protection of low voltage distribution systems against transient overvoltage caused by direct and indirect lightning stroke and switching operations
- Lightning protection classes III and IV according to IEC 62305
- Meets all requirements for installing surge protection according to DIN VDE 0100-534
- For TT & TN-S grid type

Technical Data

		SPZT123-300/3+NPE-S	SPZT123-300/3+NPE-H-S
General data			
Standards/regulations		IEC 61643-11 2011, EN 61643-11: 2012+A11: 2018	IEC 61643-11 2011, EN 61643-11: 2012+A11: 2018
IEC-Testklassifizierung		T1 / T2 / T3	T1 / T2 / T3
EN type		T1 / T2 / T3	T1 / T2 / T3
Number of ports		1	1
SPD design		Hybrid	Hybrid
Mode of protection		L-N, N-PE	L-N, N-PE
Mounting type		40 mm busbar	40 mm busbar
Surge protection fault message		visual	visual
Color		Light grey RAL 7035	Light grey RAL 7035
Housing material		Thermoplastic	Thermoplastic
Flammability rating according to UL 94		V-0	V-0
Degree of protection		IP20 / IP40 in combination with cover	IP20 / IP40 in combination with cover
Ambient temperature (operation)		-40 °C ... 85 °C	-40 °C ... 85 °C
Ambient temperature (storage/transport)		-40 °C ... 85 °C	-40 °C ... 85 °C
Permissible humidity (operation)		5 % ... 95 %	5 % ... 95 %
Altitude		≤ 4000 m (amsl (above mean sea level))	≤ 4000 m (amsl (above mean sea level))
Width		38 mm	38 mm
Height		233.4 mm	234.4 mm
Depth		102.3 mm	102.3 mm
Horizontal pitch (inkl. 5 mm)		2 Module units	2 Module units
Electrical data			
Nominal voltage AC		U_0 / U_N 240 V	240 V
Maximum continuous operating voltage	L-N	U_C 300 V AC	300 V AC
	N-PE	U_C 305 V AC	305 V AC
Max. discharge current (8/20) μ s	L-N / N-PE	I_{max} 40 kA / 100 kA	40 kA / 100 kA
Nominal discharge current (8/20) μ s	L-N / N-PE	I_n 20 kA / 80 kA	20 kA / 80 kA
Impulse current (10/350) μ s	L-N / N-PE	I_{imp} 7.5 kA / 30 kA	12.5 kA / 50 kA
Short-circuit current rating (AC)	L-N / N-PE	I_{SCCR} 25 kA	25 kA
Open Circuit Voltage of Combination Wave Generator		U_{OC} 6 kV	6 kV
Voltage protection level	L-N / N-PE	U_p 1500 V / 1500 V	1500 V / 1500 V
Follow Current Interrupt Rating	N-PE	I_f 100 A _{RMS}	100 A _{RMS}
Responding time	L-N / N-PE	t_a < 100 ns / < 100 ns	< 100 ns / < 100 ns
Overcurrent protection (max)		315 A gG	160 A gG
TOV Withstand 120 min.	L-N	U_T 442 V	442 V
TOV Withstand 200 ms	N-PE	U_T 1200 V	1200 V
Number of ports		1	1
Leakage current		I_{PE} ≤ 5 μ A	≤ 5 μ A
Connection data			
Connection method		Screw terminal blocks	Screw terminal blocks
Conductor cross section (max.)			
solid, stranded		35 mm ²	35 mm ²
flexible		25 mm ²	25 mm ²
Stripping length		18 mm	18 mm
Tightening torque		4.5 Nm	4.5 Nm

1.10

Surge Protection

xPole

Combined class 1/2/3 tested SPD with a fused supply for 40 mm busbar, SPZ

	SPZT123-300/3-S	SPZT123-300/3-H-S
Technical Data		
Connection method		
Conductor cross section (max.)		
solid, stranded	2 AWG, 35 mm ²	2 AWG, 35 mm ²
flexible	4 AWG, 25 mm ²	4 AWG, 25 mm ²
Stripping length	18 mm	18 mm
Tightening torque	4.5 Nm	4.5 Nm
Additional supply terminal (LA)		
Rated current integrierter Abgang	I _n 6.3 A	6.3 A
Back-up fuse 5 x 20 mm	FF 6.3 A	6.3 A
Wire connection method	2x Push-In	2x Push-In
Conductor cross section (max.)		
solid, stranded, flexible	14 AWG, 2.5 mm ²	14 AWG, 2.5 mm ²

Connection diagram

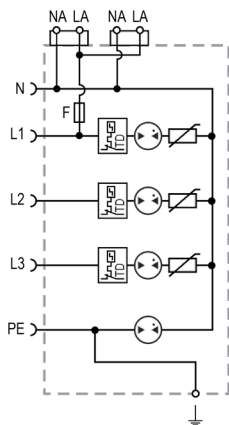

Dimensions (mm)

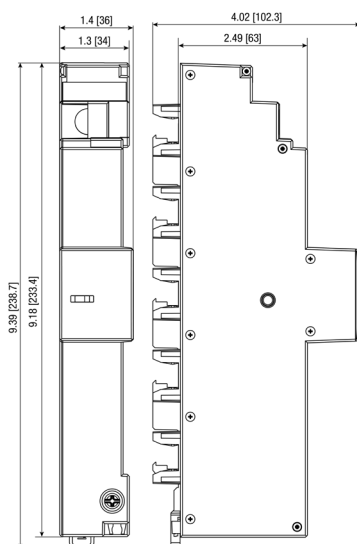

Accessories fitting the SPZT-S within the ZSD enclosure family

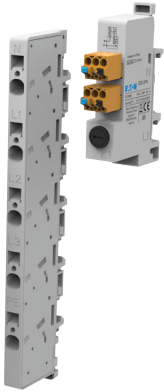

Description

- Accessories fitting the SPZT-S within the ZSD enclosure family

Feed in Terminal ZSD-ESK-25-SPZT

- Feed In terminal for a 40 mm busbar
- Perfect fit for the SPZT-S inside an ZSD enclosure
- Enables more space in the pre-meter area inside the enclosure
- Terminal according to IEC/(DIN) EN 61984 which can be deployed as mentioned in VDE-AR-N 4100
- 25 kA short circuit tested as required for pre-meter application

Poles / cross section	Rated Current In	Type Designation	Article No.	Units per package (Pcs.)
• Fits the 40 mm busbar				
5x25 mm ² (solid/stranded) 5x16 mm ² (flexible)	125 A	ZSD-ESK-25-SPZT	EP-501394	1

WA_REN_SG_02022



Technical Data

ZSD-ESK-25-SPZT	
General data	
Standards/regulations	IEC/(DIN) EN 61984 DIN VDE 0603-1 DIN VDE 0603-2-1 DIN VDE 18015-1
Pollution degree	2
Housing material	UL 94 V-0 (Thermoplast)
Ambient temperature (operation)	Ta -25°C ... 55 °C
Permissible humidity (operation)	RH 5% ... 95%
Max. altitude	4000 m
Electrical data	
Poles	5 (TN-S)
Nominal Voltage	Un 240/400 V
Rated current	In 125 A
Rated operational current	Inc 101 A
Rated short circuit current	Isc 25 kA
Max. permissible fuse	100 A gG
Rated isolation voltage	Ui 400 V
Rated impulse voltage	Uimp 6 kV
Degree of protection	IP20 (build in)
Technical data	
Mounting	12 x 5 mm Busbar (40 mm distance between busbars)
Number of conductors per terminal	5 (one conductor per connection point)
Type of terminal	Tension clamp
Permissible conductor cross section	Solid/stranded 1.5 – 25 mm ² Flexible 1.5 – 16 mm ²

Dimensions (mm)

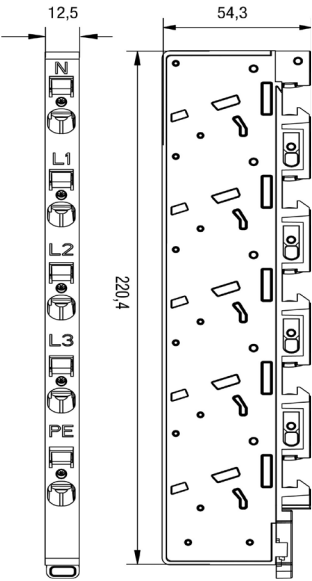

Fuse holder ZSD-SPA

- Fuse holder for the 40 mm busbar
- To be used if additional voltage supply for Gateways or similar devices need to be established in an ZSD enclosure
- 2 outgoing ways per fuse holder
- Perfect fit for the SPZT-S inside an ZSD enclosure
- Enables more space in the pre-meter area inside the enclosure
- Tested according to IEC/(DIN) EN 61984 which can be deployed as mentioned in VDE-AR-N 4100
- 25 wkA short circuit tested as required for pre-meter applications

Mounting	Rated Current In	Type Designation	Article No.	Units per package (Pcs.)
• Fits the 40mm busbar				
12x5 mm busbar	6.3A	ZSD-SPA	EP-501974	1



Technical Data

ZSD-SPA	
General data	
Standards/regulations	IEC/EN 61984 DIN VDE 0603-1 VDE-AR-N 4100
Pollution degree	2
Housing material	UL 94 V-0 (Thermoplast)
Ambient temperature (operation)	Ta -25°C ... 55 °C
Permissible humidity (operation)	RH 5% ... 95%
Max. altitude	4000 m
Electrical data	
Mounting on the busbar	Between L1 und N
Nominal Voltage	Un 240 V
Rated current	In 6.3 A
Rated short circuit current	Isc 25 kA
Rated isolation voltage	Ui 400 V
Rated impulse voltage	Uimp 6 kV
Degree of protection	IP20 (built in)
Technical data	
Mounting	12 x 5 mm Busbar (40 mm distance between busbars)
Outgoing ways	2 per fuse holder with L/N connection per outgoing way
Type of terminal	Push-In
Permissible conductor cross section	Solid/stranded 2.5 mm ² Flexible 2.5 mm ²

Dimensions (mm)

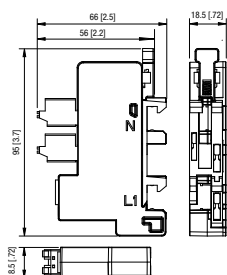

EP-502635_L



Description

- Combined class 1/2 tested SPD
- Suitable for critical infrastructure which is fitted with an external lightning protection system
- Integrated auxiliary contact to provide the status of the SPD
- Double terminal offers the possibility to connect the SPD in series to the installation
- More compact design (3 pole type in 3 units, 3+1 type in 4 units)

Types

SPH „AX“

- Base, insert and auxiliary contact in one device
- I_{imp} of 25 kA per phase
- Suitable for applications with external lightning protection system (LPS I/II/III/IV)

SPH „NPE“

- Suitable for TT and TN-S systems due to the 3+1 connection
- Galvanic separated SPD path between neutral and protective earth

Poles	Max. Continuous Operating Voltage U_c	Type Designation	Article No.	Units per package
-------	--	---------------------	-------------	----------------------

Combined Surge Protective Device SPHT12-350

- incl. FM contact (change-over contact)
- for TN-C

sg04518_r



3 pole	350 VAC	PHASED OUT	SPRT12-350/3-AX	195235	1
3 pole	275 VAC	NEW	SPHT12-350/3-AX	EP-502636	1

- incl. FM contact (change-over contact)
- for TN-S/TT

sg04418_r



3 pole+NPE	350 VAC	PHASED OUT	SPRT12-350/3+NPE-AX	195236	1
3 pole+NPE	275 VAC	NEW	SPHT12-350/3+NPE-AX	EP-502635	1

Range of protection	Max. Continuous Operating Voltage U_c	Type Designation	Article No.	Units per package
---------------------	--	---------------------	-------------	----------------------

Insert for SPHT12-350

sg04318_r



L-N / L-PEN	350 VAC	PHASED OUT	SPRT12-350	195237	1
N-PE	350 VAC	PHASED OUT	SPRT12-350/NPE	195238	1
L-N / L-PEN	275 VAC	NEW	SPHT12-350	EP-502637	1
N-PE	305 VAC	NEW	SPHT12-350/NPE	EP-502638	1

Description Surge Protective Class T1/T2

- Ready-to-connect Combined Surge Protection Device Type 1/2 on the basis of spark gaps
- Consisting of the base unit and plug-type modules
- Scope of application:
To protect consumer systems against transient overvoltages caused by direct and indirect lightning strikes, as well as switching operations
- Lightning protection class I and II according to IEC 62305

Technical Data

	SPHT12-350/3+NPE-AX	SPHT12-350/3+AX
General data		
Standards/regulation	IEC 61643-11:2011; EN 61643-11:2012+A11:2018	IEC 61643-11:2011; EN 61643-11:2012+A11:2018
IEC test classification	T1 / T2	T1 / T2
EN type	T1 / T2	T1 / T2
Number of ports	1	1
SPD design	Phase GDT	Phase GDT
Mode of protection	L-N, N-PE	L-PEN
Mounting type	DIN rail 35 mm	DIN rail 35 mm
Surge protection fault message	Optical, remote indicator contact	Optical, remote indicator contact
Color Light	Light grey RAL 7035	Light grey RAL 7035
Insulating material	Thermoplastics	Thermoplastics
Housing material	PA6, 30% GF	PA6, 30% GF
Air clearances and creepage distances (according to EN 60664-1 and EN 61643-11)		
Degree of pollution	2	2
Overvoltage category	II, III, IV	II, III, IV
Material group	I	I
CTI value of material	600	600
U_{max}	1624 V	1624 V
Flammability rating according to UL 94	V-0	V-0
Degree of protection	IP20 (built-in)	IP20 (built-in)
Shock (operation)	3 M4 (11ms), 3 M5 (6ms)	3 M4 (11ms), 3 M5 (6ms)
Vibration (operation)	3 M5	3 M5
Ambient temperature (operation)	-40 °C to +85 °C	-40 °C to +85 °C
Ambient temperature (storage/transport)	-40 °C to +85 °C	-40 °C to +85 °C
Permissible humidity (operation)	5%...95%	5%...95%
Altitude	2000 m	2000 m
Width	72	54
Height	86	86
Depth	105	105
Horizontal pitch	4 Module units	3 Module units
Electrical data		
Nominal voltage	U_N 240 V	240 V
Nominal frequency	f_N 50 Hz	50 Hz
Maximum continuous operating voltage	U_C 275 V (L-N), 305 V (N-PE)	275 V
Nominal discharge current (8/20) μ s	I_n	
(L-PEN)	/	25 kA
(L-N)	25 kA	/
(N-PE)	100 kA	/
Maximum discharge current (8/20) μ s	I_{max}	
(L-PEN)	/	65 kA
(L-N)	65 kA	/
(N-PE)	150 kA	/
Impulse discharge current (10/350) μ s	(L-N)	
Peak value	I_{imp} 25 kA	/
Impulse discharge current (10/350) μ s (L-PE(PEN))		
Peak value	I_{imp} /	25 kA
Impulse discharge current (10/350) μ s (N-PE)		
Peak value	I_{imp} 100 kA	/
Follow current interrupt rating	I_{fi}	
(L-PEN)	/	50 kA
(L-N)	50 kA	/
(N-PE)	100 A	/
Short-circuit current rating	I_{SCCR} 50 kA	50 kA

		SPHT12-350/3+NPE-AX	SPHT12-350/3+AX
Voltage protection level	U_p		
(L-PEN)		/	1500 V
(L-N)		1700 V	/
(N-PE)		1500 V	/
Residual voltage U_{res} (min 250A gG)	U_{res}		
(L-PEN)		/	1400 V
(L-N)		1400 V	/
(N-PE)		305 V	/
TOV behavior at	U_T		
(L-PEN)		/	442 V
(L-N)		442 V	/
(N-PE)		1200 V	/
Response time		< 100 ns	< 100 ns
Max. backup fuse with branch wiring		315 A gG	315 A gG
Additional technical data			
Follow current interrupt rating	I_{fi}	50 kA (L-N); 100 A (N-PE)	50 kA
Short-circuit current rating	I_{SCCR}	100 kA	100 kA
Remote signaling			
Connection name		Remote fault indicator contact	Remote fault indicator contact
Switching function		changeover contact	changeover contact
Connection method		Plug-in	Plug-in
Operating voltage		125 V AC ... 250 V AC; 12 V DC ... 48 V DC	125 V AC ... 250 V AC; 12 V DC ... 48 V DC
Operating current		1A AC; 0.5 A DC	1A AC; 0.5 A DC
Conductor cross section			
flexible		0.25 mm ² ... 1.5 mm ²	0.25 mm ² ... 1.5 mm ²
solid		0.25 mm ² ... 1.5 mm ²	0.25 mm ² ... 1.5 mm ²
AWG		23 AWG ... 16 AWG	23 AWG ... 16 AWG
Stripping length		10 mm	10 mm
Connection data			
Connection method		Screw terminal blocks	Screw terminal blocks
Connection method		Screw terminal blocks	Screw terminal blocks
Screw thread		M6	M6
Connection technology		Screw terminal blocks	Screw terminal blocks
Conductor cross section			
flexible, solid		1.5 mm ² ... 35 mm ² (solid, stranded), 25 mm ² (flexible)	1.5 mm ² ... 35 mm ² (solid, stranded), 25 mm ² (flexible)
AWG		15 AWG ... 2 AWG (solid, stranded), 4 AWG (flexible)	15 AWG ... 2 AWG (solid, stranded), 4 AWG (flexible)
Stripping length		18 mm	18 mm
Tightening torque		4.5 Nm	4.5 Nm

Circuit diagrams

SPHT12-350/3-AX

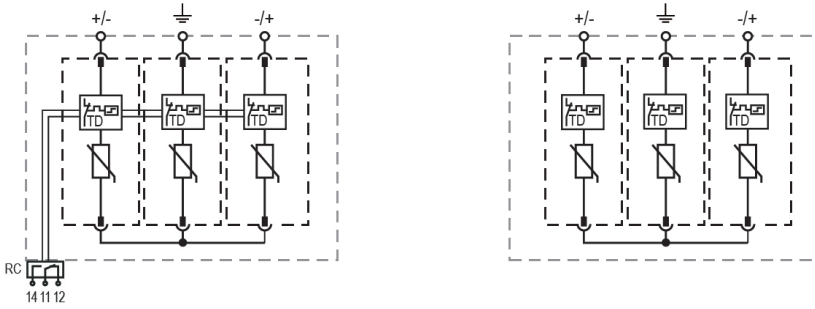

Dimensions (mm)

SPHT12-350/3-AX

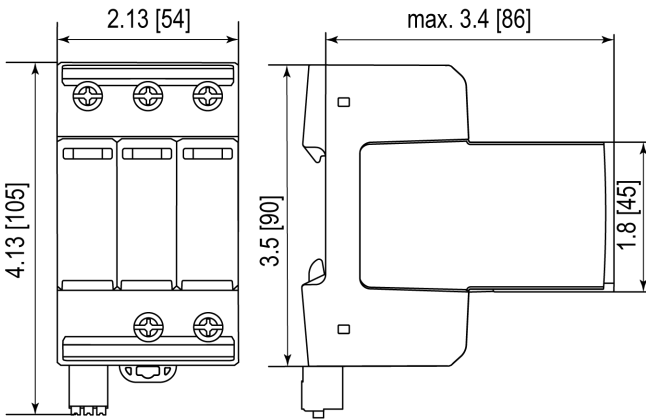

SPHT12-350/3+NPE-AX

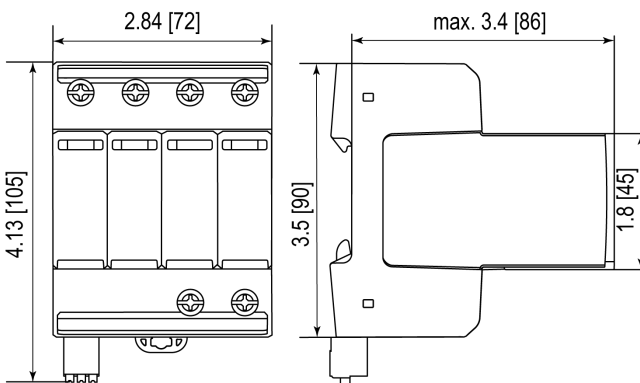

SPHT12-350, SPHT12-350/NPE

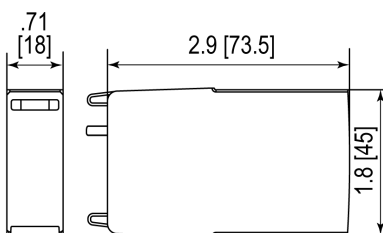

184750_L



Description

- Combined test class 1/2 tested SPD
- Suitable for applications with an external lightning protection system (where also a limp of 12.5 kA per phase is needed)
- For TT, TN-C and TN-S supply systems
- Auxiliary contact and busbar available as an accessory

Types

SPB „BB“

- SPD which can be connected via busbar to a 4pole protective device/ switch disconnector

SPB „NPE“

- Galvanic separated SPD path between neutral and protective earth
- Suitable for TT and TN-S systems due to the 3+1 connection

Description	Type Designation	Article No.	Units per package
-------------	------------------	-------------	-------------------

Lightning current arrester - surge arrester sets, Lightning protection classes III, IV

sg28912



Single phase supply / 2+0 connection

TN-S-Set 2pole	SPBT12-280/2	158309	1 / 60
----------------	--------------	--------	--------

184752.L



Single phase supply / 1+1 connection

TN-S/TT Set 1+N Set 50 kA	SPBT12-280-1+NPE50	184752	1 / 30
TN-S/TT-Set 1+1pole 100 kA	SPBT12-280-1+NPE	158308	1 / 40

sg29612



Three phase supply

TN-C-Set 3pole (3+0 connection)	SPBT12-280/3	158330	1 / 40
TN-S-Set 4pole (4+0 connection)	SPBT12-280/4	158331	1 / 30

184750.L



Three phase supply / 3+1 connection (50 kA)

TN-S/TT Set 3+N Set	SPBT12-280-3+NPE50	184750	1 / 80
TN-S/TT Set 3+N Set with busbar	SPBT12-280-3+NPE50/BB	184751	1

sg65112



Three phase supply / 3+1 connection (100 kA)

TN-S/TT-Set 3+1pole	SPBT12-280-3+NPE	158332	1 / 80
TN-S/TT-Set 3+1pole with busbar	SPBT12-280-3+NPE/BB	158333	1

Description	Type Designation	Article No.	Units per package
-------------	------------------	-------------	-------------------

Accessories

Auxiliary switch for SPBT12-280	ASAUWSC-SPM	131785	4/120
Busbar	ZV-KSBL...		

Impulse current I_{imp} (10/350) μ s	Type Designation	Article No.	Units per package
---	------------------	-------------	-------------------

Lightning current arrester - surge arrester SPBT12

Complete

12.5 kA L - (PE) N	SPBT12-280/1	158306	12/120
50 kA N-PE	SPBT12-NPE50	184749	1/60
100 kA N-PE	SPBT12-NPE100	158307	1/60

Insert

12.5 kA Insert	SPBT12-280	167341	2/120
----------------	------------	--------	-------

sg63312



Description Surge Protective Class T1&T2

- Field of application:
For the protection of low voltage distribution systems against transient overvoltage caused by direct and indirect lightning stroke and switching operations
- Application according to IEC 60364-5-53 Clause 534
- Test class **I**, **II** according to IEC 61643-11
- SPD-type **T1**, **T2** according to EN 61643-11
- Lightning protection classes III and IV according to IEC 62305
- Busbars ZV-KSBI are available for all customary applications

Technical Data

		SPBT12-280...	SPBT12-NPE50	SPBT12-NPE100
Electrical	per pole			
Responding time (rate of voltage rise 5 kV/μs)		< 25 ns	< 100 ns	< 100 ns
Voltage protection level	U_p	≤ 1.5 kV	< 1.4 kV	< 1.5 kV
Voltage protection level at 5 kA (8/20) μs	U_p	950 V	–	–
Max. continuous operating voltage	U_c	280 VAC	260 VAC	255 VAC
TOV test value	U_T	335 VAC (5 s)	1200 VAC (200 ms)	1200 VAC (200 ms)
Rated frequency		50 Hz	50 Hz	50 Hz
Open circuit voltage	U_{oc}	10 kV	–	20 kV
Nominal discharge current (8/20) μs	I_n	25 kA	50 kA	100 kA
Max. discharge current	I_{max}	50 kA	100 kA	100 kA
Impulse current (10/350) μs	I_{imp}			
Peak current		12.5 kA	50 kA	100 kA
Follow current interrupt rating	I_{fi}	–	100 A _{r.m.s.}	100 A _{r.m.s.}
Maximum back-up fuse		160 AgL/gG	–	–
Maximum short-circuit current		50 kA _{r.m.s.}	–	–
Connection diagram				

Mechanical

Frame size		45 mm	45 mm	45 mm
Device height		80 mm	80 mm	80 mm
Device width		17.5 mm	17.5 mm	35 mm
Weight		121 g	93 g	250 g
Permitted ambient temperature		-40°C to +70°C	-40°C to +70°C	-40°C to +70°C
Degree of protection		IP20	IP20	IP20
Upper and lower lift terminal capacity		4 - 25 mm ²	top 4 - 50 mm ² , bottom 4 - 35 mm ²	4 - 35 mm ²
Upper and lower open mouthed terminals for busbar thickness up to		1.5 mm	top - / bottom 1.5 mm	1.5 mm
Tightening torque of terminal screws		2.4 - 3 Nm	2.4 - 3 Nm	2.4 - 3 Nm
Quick fastening on DIN rail according to		IEC/EN 60715	IEC/EN 60715	IEC/EN 60715
Accessories: busbars 16 mm ²		Type ZV-KSBI ...	Type ZV-KSBI ...	Type ZV-KSBI ...

Dimensions (mm)

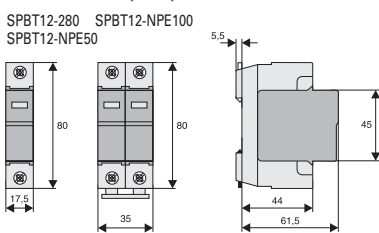

Lightning current arrester - surge arrester sets, Lightning protection classes III, IV

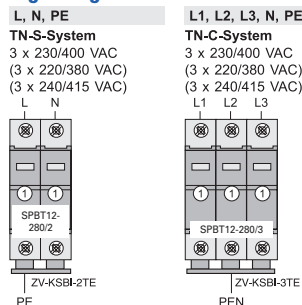

① ... SPBT12-280

Technical Data

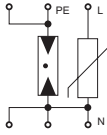
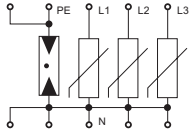
		SPBT12-280-1+NPE50	SPBT12-280-3+NPE50
Electrical	per pole		
Responding time (rate of voltage rise 5 kV/μs)	L-N / N-PE	< 25 ns / < 100 ns	< 25 ns / < 100 ns
Voltage protection level	L-N / L-PE / N-PE	U_p < 1.5 kV	< 1.5 kV
Max. continuous operating voltage	L-N / N-PE	U_C 280 VAC / 260 VAC	280 VAC / 260 VAC
TOV test value		U_T	
5 s	L-N / L-PE	348 VAC / 370 VAC	348 VAC / 370 VAC
200 ms	N-PE	1200 VAC	1200 VAC
Rated frequency		50/60 Hz	50/60 Hz
Open circuit voltage		U_{oc} 10 kV	20 kV
Nominal discharge current (8/20) μs	L-N / N-PE	I_n 25 kA / 50 kA	3x25 kA / 50 kA
Max. discharge current	L-N / N-PE	I_{max} 50 kA / 100 kA	3x50 kA / 100 kA
Impulse current (10/350) μs		I_{imp}	
Peak current	L-N / N-PE	12.5 kA / 50 kA	3x12.5 kA / 50 kA
Follow current interrupt rating	N-PE	I_{fi} 100 A _{r.m.s.}	100 A _{r.m.s.}
Maximum back-up fuse		—	—
Maximum short-circuit current		—	—
Connection diagram			

Mechanical

Frame size	45 mm	45 mm
Device height	80 mm	80 mm
Device width	35 mm	70 mm
Weight	218 g	470 g
Permitted ambient temperature	-40°C to +70°C	-40°C to +70°C
Degree of protection (built-in)	IP40	IP40
Upper and lower lift terminal capacity		
L, N	4 - 25 mm ²	4 - 25 mm ²
N, PE	4 - 50 mm ²	4 - 50 mm ²
Upper and lower open mouthed terminals for busbar thickness up to	1.5 mm	1.5 mm
Tightening torque of terminal screws	2.4 - 3 Nm	2.4 - 3 Nm
Quick fastening on DIN rail according to	IEC/EN 60715	IEC/EN 60715
Accessories: busbars 16 mm ²	Type ZV-KSBI ...	Type ZV-KSBI ...

Lightning current arrester - surge arrester sets, Lightning protection classes III, IV

L, N, PE

TN-S-System
3 x 230/400 VAC
(3 x 220/380 VAC)
(3 x 240/415 VAC)



L1, L2, L3, N, PE

TN-S/TT-System
3 x 230/400 VAC
(3 x 220/380 VAC)
(3 x 240/415 VAC)

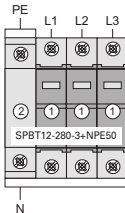

TN-S/TT-System
3 x 230/400 VAC
(3 x 220/380 VAC)
(3 x 240/415 VAC)

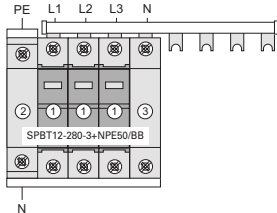

- ① ... SPBT12-280
- ② ... SPBT12-NPE50
- ③ ... ASLTT-63

Technical Data

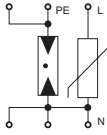
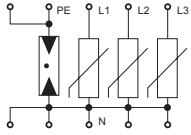
		SPBT12-280-1+NPE	SPBT12-280-3+NPE
Electrical	per pole		
Responding time (rate of voltage rise 5 kV/μs)	L-N / N-PE	< 25 ns / < 100 ns	< 25 ns / < 100 ns
Voltage protection level	L-N / L-PE / N-PE	U_p < 1.5 kV	< 1.5 kV
Max. continuous operating voltage	L-N / N-PE	U_c 280 VAC / 255 VAC	280 VAC / 255 VAC
TOV test value		U_T	
5 s	L-N / L-PE	348 VAC / 370 VAC	348 VAC / 370 VAC
200 ms	N-PE	1200 VAC	1200 VAC
Rated frequency		50 Hz	50 Hz
Open circuit voltage		U_{oc} 10 kV	20 kV
Nominal discharge current (8/20) μs	L-N / N-PE	I_n 25 kA / 100 kA	3x25 kA / 100 kA
Max. discharge current	L-N / N-PE	I_{max} 50 kA / 100 kA	3x50 kA / 100 kA
Impulse current (10/350) μs		I_{imp}	
Peak current	L-N / N-PE	12.5 kA / 100 kA	3x12.5 kA / 100 kA
Follow current interrupt rating	N-PE	100 $A_{r.m.s.}$	100 $A_{r.m.s.}$
Maximum back-up fuse		160 AgL/gG	160 AgL/gG
Maximum short-circuit current		50 $kA_{r.m.s.}$	50 $kA_{r.m.s.}$
Connection diagram			
Mechanical			
Frame size		45 mm	45 mm
Device height		80 mm	80 mm
Device width		52.5 mm	87.5 mm
Weight		375 g	626 g
Permitted ambient temperature		-40°C to +70°C	-40°C to +70°C
Degree of protection (built-in)		IP40	IP40
Upper and lower lift terminal capacity			
L, N		4 - 25 mm ²	4 - 25 mm ²
N, PE		4 - 35 mm ²	4 - 35 mm ²
Upper and lower open mouthed terminals for busbar thickness up to		1.5 mm	1.5 mm
Tightening torque of terminal screws		2.4 - 3 Nm	2.4 - 3 Nm
Quick fastening on DIN rail according to		IEC/EN 60715	IEC/EN 60715
Accessories: busbars 16 mm ²		Type ZV-KSBI ...	Type ZV-KSBI ...

Lightning current arrester - surge arrester sets, Lightning protection classes III, IV

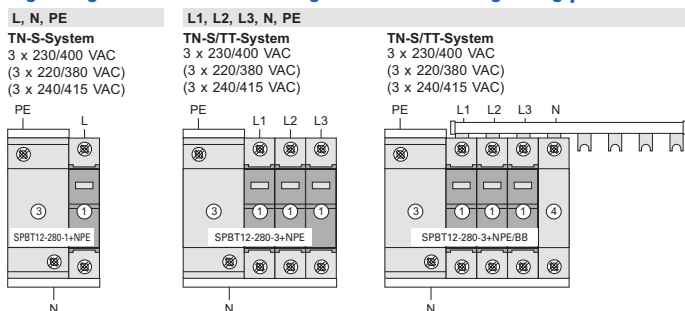

- ① ... SPBT12-280
- ② ... ASAXSC-SPM
- ③ ... SPBT12-NPE100
- ④ ... ASLTT-63

SG04913



Description

- Class 2 tested SPD
- Suitable for applications without an external lightning protection system
- For TT, TN-C and TN-S supply systems
- Auxiliary contact and busbar available as an accessory
- SPCT 280 and 335 (inserts and combinations) are additional class 3 tested

Types

SPC „BB“

- SPD which can be connected via busbar to a 4pole protective device/switch disconnector

SPC „NPE“

- Galvanic separated SPD path between neutral and protective earth
- Suitable for TT and TN-S systems due to the 3+1 connection

Poles	Max. Continuous Operating Voltage U_c	I_n (8/20) μ s	Type Designation	Article No.	Units per package
-------	---	----------------------	------------------	-------------	-------------------

Plug-in surge arrester SPCT2

sg04413



Single phase supply / 1+0 connection

1pole	280 VAC	20 kA	SPCT2-280/1	T3 tested	167593	12/120
1pole	335 VAC	20 kA	SPCT2-335/1	T3 tested	167598	12/120
1pole	385 VAC	20 kA	SPCT2-385/1		167603	12/120
1pole	460 VAC	20 kA	SPCT2-460/1		167608	12/120
1pole	580 VAC	20 kA	SPCT2-580/1	PHASED OUT	167613	12/120
1pole	260 VAC	40 kA	SPCT2-NPE60/1	T3 tested	167618	12/120

sg04613



Single phase supply / 1+1 connection

1+N	280 VAC	20 kA	SPCT2-280-1+NPE	T3 tested	167619	1/60
1+N	335 VAC	20 kA	SPCT2-335-1+NPE	T3 tested	167621	1/60
1+N	385 VAC	20 kA	SPCT2-385-1+NPE		167623	1/60
1+N	460 VAC	20 kA	SPCT2-460-1+NPE		167625	1/60

sg04513



Single phase supply / 2+0 connection

2pole	280 VAC	2x20 kA	SPCT2-280/2	T3 tested	167594	1/60
2pole	335 VAC	2x20 kA	SPCT2-335/2	T3 tested	167599	1/60
2pole	385 VAC	2x20 kA	SPCT2-385/2		167604	1/60
2pole	460 VAC	2x20 kA	SPCT2-460/2		167609	1/60

sg04713



Three phase supply / 3+0 connection (TN-C)

3pole	280 VAC	3x20 kA	SPCT2-280/3	T3 tested	167595	1/40
3pole	335 VAC	3x20 kA	SPCT2-335/3	T3 tested	167600	1/40
3pole	385 VAC	3x20 kA	SPCT2-385/3		167605	1/40
3pole	460 VAC	3x20 kA	SPCT2-460/3		167610	1/40

sg04913



Three phase supply / 3+1 connection (TN-S/TT)

3+N	280 VAC	20 kA	SPCT2-280-3+NPE	T3 tested	167620	1/30
3+N	335 VAC	20 kA	SPCT2-335-3+NPE	T3 tested	167622	1/30
3+N	385 VAC	20 kA	SPCT2-385-3+NPE		167624	1/30
3+N	460 VAC	20 kA	SPCT2-460-3+NPE		167626	1/30
3+N	580 VAC	20 kA	SPCT2-580-3+NPE	PHASED OUT	167628	1/30

sg06514

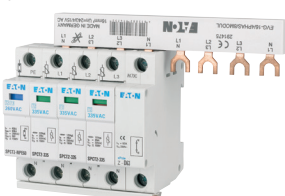

Three phase supply / 3+1 connection with additional busbar

3+N/BB	280 VAC	3x20 kA	SPCT2-280-3+NPE/BB	T3 tested	167629	1
3+N/BB	335 VAC	3x20 kA	SPCT2-335-3+NPE/BB	T3 tested	167630	1
3+N/BB	385 VAC	3x20 kA	SPCT2-385-3+NPE/BB		167631	1
3+N/BB	460 VAC	3x20 kA	SPCT2-460-3+NPE/BB		167632	1

sg04813



Poles	Max. Continuous Operating Voltage U_c	I_n (8/20) μ s	Type Designation		Article No.	Units per package
Three phase supply / 4+0 connection (TN-S)						
4pole	280 VAC	4x20 kA	SPCT2-280/4	T3 tested	167596	1/30
4pole	335 VAC	4x20 kA	SPCT2-335/4	T2 tested	167601	1/30
4pole	385 VAC	4x20 kA	SPCT2-385/4		167606	1/30
4pole	460 VAC	4x20 kA	SPCT2-460/4		167611	1/30

sg08213



Plug-in surge arrester SPCT2. Insert

Insert (1pole/path)

Insert	280 VAC	20 kA	SPCT2-280	T3 tested	167592	2/120
Insert	335 VAC	20 kA	SPCT2-335	T2 tested	167597	2/120
Insert	385 VAC	20 kA	SPCT2-385		167602	2/120
Insert	460 VAC	20 kA	SPCT2-460		167607	2/120
Insert	260 VAC	40 kA	SPCT2-NPE60		167617	2/120

Description Surge Protective Class T2

- Field of application:
For the protection of low voltage distribution systems against transient overvoltage caused by direct and indirect lightning stroke and switching operations
- Test class **[II]** according to IEC 61643-11
- SPD-type **[T2]**, according to EN 61643-11
- Auxiliary switch ASAXSC-SPM for remote message transmission can be mounted onto the device
- SPCT 280 and 335 are additional class 3 tested

Technical Data

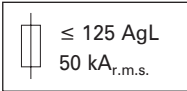
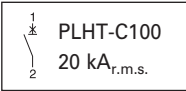
Inserts	SPCT2-280	SPCT2-335	SPCT2-385	SPCT2-460
Electrical				
Mechanical coding	x	x	x	x
Responding time (rate of voltage rise 5 kV/μs)	< 25 ns	< 25 ns	< 25 ns	< 25 ns
Voltage protection level at nominal discharge current / U_{oc}	U_p < 1.4 kV	< 1.5 kV	< 1.7 kV	< 1.9 kV
Voltage protection level at 5 kA (8/20) μs	U_p 1000 V	1200 V	1350 V	1700 V
Max. continuous operating voltage	U_c 280 VAC	335 VAC	385 VAC	460 VAC
TOV test value (5 s)	U_T 348 VAC	348 VAC	348 VAC	580 VAC
Rated frequency	50 Hz	50 Hz	50 Hz	50 Hz
Open circuit voltage	U_{oc} 10 kV	5 kV	–	–
Nominal discharge current (8/20) μs	I_n 20 kA	20 kA	20 kA	20 kA
Max. discharge current	I_{max} 40 kA	40 kA	40 kA	40 kA
Follow current interrupt rating	I_{fi} –	–	–	–
Open Circuit Voltage	U_{oc} [T3] 6 kV	6 kV	–	–
Voltage protection level	U_p [T3] 900 V	1000 V	–	–
Maximum back-up fuse				
Maximum short-circuit current				

Connection diagram

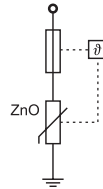

Mechanical

Frame size	45 mm
Device height	80 mm
Device width	
1pole	17.5 mm (1MU)
1+1pole, 2pole	35 mm (2MU)
3pole	52.5 mm (3TE)
3+1pole, 4pole	70 mm (4TE)
Mechanical coding	
1pole	x
1+1pole	yx
2pole	xx
3pole	xxx
3+1pole	yxxx
4pole	xxxx
Weight base 1P, 1+1P, 2P, 3P, 3+1P, 4P	53/120/120/180/240/240 g
Weight complete devices 1P, 1+1P, 2P, 3P, 3+1P, 4P	110/201/220/330/412/440 g
Permitted ambient temperature	-40°C to +70°C
Degree of protection	IP20
Upper and lower lift terminal capacity	4 - 25 mm ²
Upper and lower open mouthed terminals for busbar thickness up to	1.5 mm
Tightening torque of terminal screws	2.4 - 3 Nm
Quick fastening on DIN rail according to	IEC/EN 60715
Accessories: busbars 16 mm ²	Type ZV-KSBI ...

Technical Data

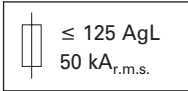
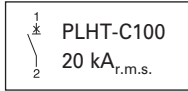
Inserts	SPCT2-NPE60	
Electrical		
Mechanical coding	y	
Responding time (rate of voltage rise 5 kV/ μ s)	< 100 ns	
Voltage protection level at nominal discharge current / U_{oc}	U_p	< 1.5 kV
Voltage protection level at 5 kA (8/20) μ s	U_p	–
Max. continuous operating voltage	U_c	260 VAC
TOV test value	U_T	1200 VAC (200 ms)
Rated frequency	50 Hz	
Open circuit voltage	U_{oc}	6 kV
Nominal discharge current (8/20) μ s	I_n	40 kA
Max. discharge current	I_{max}	60 kA
Follow current interrupt rating	I_{fi}	100 A _{r.m.s.}
Maximum back-up fuse		
Maximum short-circuit current		

Connection diagram

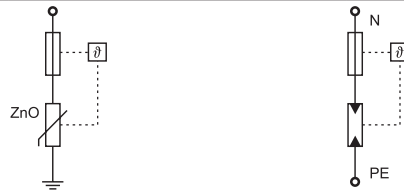



Mechanical

Frame size	45 mm
Device height	80 mm
Device width	
1pole	17.5 mm (1MU)
1+1pole, 2pole	35 mm (2MU)
3pole	52.5 mm (3TE)
3+1pole, 4pole	70 mm (4TE)
Mechanical coding	
1pole	x
1+1pole	yx
2pole	xx
3pole	xxx
3+1pole	yxxx
4pole	xxxx
Weight base 1P, 1+1P, 2P, 3P, 3+1P, 4P	53/120/120/180/240/240 g
Weight complete devices 1P, 1+1P, 2P, 3P, 3+1P, 4P	110/201/220/330/412/440 g
Permitted ambient temperature	-40°C to +70°C
Degree of protection	IP20
Upper and lower lift terminal capacity	4 - 25 mm ²
Upper and lower open mouthed terminals for busbar thickness up to	1.5 mm
Tightening torque of terminal screws	2.0 - 3 Nm
Quick fastening on DIN rail according to	IEC/EN 60715
Accessories: busbars 16 mm ²	Type ZV-KSBI ...

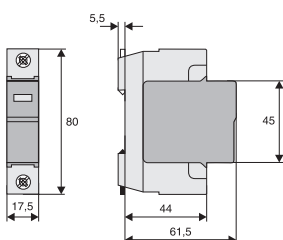
Dimensions (mm)



Technical Data

	SPCT2-1+NPE		SPCT2-3+NPE	
Electrical				
Mechanical coding			yX	yxxx
Responding time (rate of voltage rise 5 kV/μs)	L-N/N-PE/L-PE		< 25ns/< 100ns/< 100ns	< 25ns/< 100ns/< 100ns
Max. continuous operating voltage	L-N/N-PE	U_C	335VAC/260VAC	280VAC/260VAC
TOV test value		U_T		
5 s	L-N		415 VAC	350 VAC
200 ms	N-PE		1200 VAC	1200 VAC
Rated frequency			50 Hz	50 Hz
Nominal discharge current (8/20) μs	L-N/N-PE/L-PE	I_n	20 kA	20 kA
Voltage protection level at I_n	L-N/N-PE/L-PE	U_D	≤ 1600V/≤ 1000V/≤ 1650V	≤ 1000V/≤ 1000V/≤ 1300V
Max. discharge current (8/20) μs	L-N/N-PE/L-PE	I_{max}	40 kA	40 kA
Follow current interrupt rating	N-PE	I_{fi}	100 A _{r.m.s.}	100 A _{r.m.s.}
Maximum back-up fuse			 ≤ 125 AgL	 PLHT-C100
Maximum short-circuit current			50 kA _{r.m.s.}	20 kA _{r.m.s.}

Connection diagram

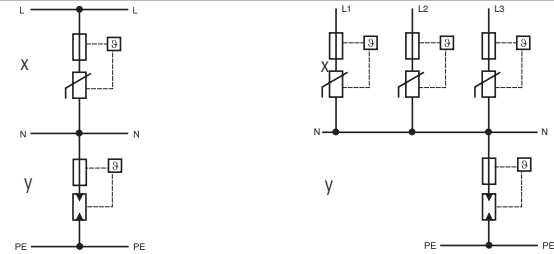

Mechanical

Mechanical coding of base	yX	yxxx
Frame size	45 mm	45 mm
Device height	80 mm	80 mm
Device width	35 mm	70 mm
Weight	201 g	412 g
Permitted ambient temperature	-40°C to +70°C	-40°C to +70°C
Degree of protection (built-in)	IP40	IP40
Upper and lower lift terminal capacity	1 - 25 mm ²	1 - 25 mm ²
Upper and lower open mouthed terminals for busbar thickness up to	1.5 mm	1.5 mm
Tightening torque of terminal screws	2.4 - 3 Nm	2.4 - 3 Nm
Quick fastening on DIN rail according to	IEC/EN 60715	IEC/EN 60715
Accessories: busbars 16 mm ²	Type ZV-KSBI ...	Type ZV-KSBI ...

Dimensions (mm)

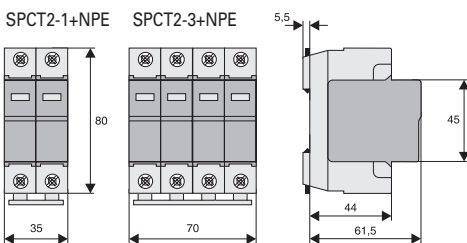

Application Examples

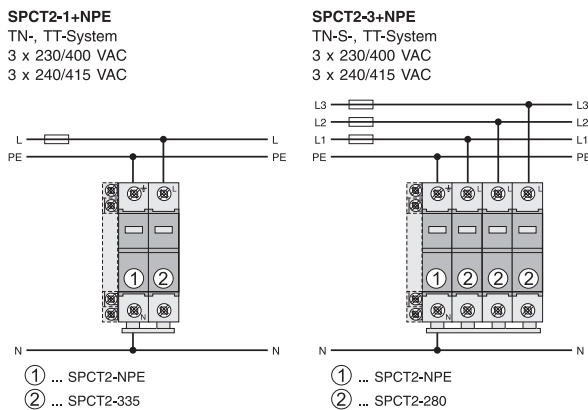

Surge arrester Sets

SPCT2 class 2/3 tested with pre-fitted busbar (BB)

Surge Arrester Set SPCT2-335-3+NPE/BB

- The 3+1 circuit offers a universal solution for surge protection in low voltage distribution systems
- Suitable for TT- and TN-S-systems according to IEC 60364-5-53 Clause 534
- Remote message transmission is possible by mounting auxiliary switch ASAXSC-SPM
- Busbar connected, minimum installation work required

Content**SPCT2-335-3+NPE/BB**

- | | |
|--------------------------|-----------------------|
| - 1 unit SPCT2-335-3+NPE | Surge arrester |
| - 1 unit ASLTT-63 | Lead-through terminal |
| - busbar included | |

sg64812



Description

- Test class 2 tested SPD
- Fulfills the minimum requirements for an application without external lightning protection system
- For TT, TN-C and TN-S supply systems
- Auxiliary contact and busbar available as an accessory

Types

SPE „NPE“

- Galvanic separated SPD path between neutral and protective earth
- Suitable for TT and TN-S systems due to the 3+1 connection

Poles	Max. Continuous Operating Voltage U_c	I_n (8/20) μ s	Type Designation	Article No.	Units per package
-------	---	----------------------	------------------	-------------	-------------------

Surge arrester SPET2, 1- to 4pole

SG64012



Single phase supply / 1+0 connection

1pole	280 VAC	10 kA	SPET2-280/1	168741	2/120
1pole	335 VAC	10 kA	SPET2-335/1	168695	2/120

Single phase supply / 1+1 connection

1pole+N	280 VAC	10 kA	SPET2-280/1+NPE	168699	1/60
1pole+N	335 VAC	10 kA	SPET2-335/1+NPE	168701	1/60

Single phase supply / 2+0 connection

2pole	280 VAC	2x10 kA	SPET2-280/2	168742	1/60
2pole	335 VAC	2x10 kA	SPET2-335/2	168696	1/60

SG64812



Three phase supply / 3+0 connection (TN-C)

3pole	280 VAC	3x10 kA	SPET2-280/3	168692	1/40
3pole	335 VAC	3x10 kA	SPET2-335/3	168697	1/40

Three phase supply / 3+1 connection (TN-S / TT)

3pole+N	280 VAC	10 kA	SPET2-280/3+NPE	168700	1/30
3pole+N	335 VAC	10 kA	SPET2-335/3+NPE	168702	1/30

Three phase supply / 4+0 connection (TN-S / TT)

4pole	280 VAC	4x10 kA	SPET2-280/4	168693	1/30
4pole	335 VAC	4x10 kA	SPET2-335/4	168698	1/30

Surge arrester SPET2, Insert

sg63412



Insert (1pole/path)

Insert	280 VAC	10 kA	SPET2-280	168740	2/120
Insert	335 VAC	10 kA	SPET2-335	168694	2/120

Accessories

SG83311



Auxiliary switch for SPBT12, SPCT2, SPET2, SPDT3	ASAUWSC-SPM	131785	8/80
--	-------------	--------	------

Description	Type Designation	Article No.	Units per package
-------------	------------------	-------------	-------------------

Lead-through terminal for SPB, ASLTT-63

SG59511





Lead-through terminal	ASLTT-63	131784	12/120
-----------------------	----------	--------	--------

Description Surge arrester SPET2

- Field of application:
For the protection of low voltage distribution systems against transient overvoltage caused by direct and indirect lightning stroke and switching operations
- Test class **II** according to IEC 61643-11
- SPD-type **T2**, according to EN 61643-11
- Busbars ZV-KSBI are available for all customary applications
- Suitable for busbar connection to all Xtra Combinations switchgear

Technical Data

	SPET2-280	SPET2-335	SPET2-NPE60
Electrical			
Responding time (rate of voltage rise 5 kV/μs)	< 25 ns	< 25 ns	< 100 ns
Voltage protection level at nominal discharge current	U_p < 1.2kV	< 1.3kV	< 1.5 kV
Voltage protection level at 5 kA (8/20) μs	U_p 1000 V	1200 V	-
Max. continuous operating voltage	U_c 280 VAC	335 VAC	260 VAC
TOV test value (5 s)	U_T 335 VAC	400 VAC	1200 VAC
Rated frequency	50 Hz	50 Hz	50 Hz
Nominal discharge current (8/20) μs	I_n 10 kA	10 kA	40 kA
Max. discharge current	I_{max} 20 kA	20 kA	60 kA
Follow current interrupt rating	I_{fi} -	-	100 A _{r.m.s.}
Maximum back-up fuse	 ≤ 125 AgL	 ≤ C63	
Maximum short-circuit current	50 kA _{r.m.s.}	10 kA _{r.m.s.}	

Connection diagram



Mechanical

Frame size	45 mm
Device height	80 mm
Device width	17.5 mm
Weight	87 g
Permitted ambient temperature	-40°C to +70°C
Degree of protection	IP20
Upper and lower lift terminal capacity	4 - 25 mm ²
Upper and lower open mouthed terminals for busbar thickness up to	1.5 mm
Tightening torque of terminal screws	2.4 - 2.5 Nm
Quick fastening on DIN rail according to	IEC/EN 60715
Accessories: busbars 16 mm ²	Type ZV-KSBI ...

Dimensions (mm)

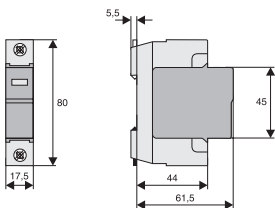

Application Examples SPET2 according to IEC 60364-5-53 Clause 534

TN-C-System
3 x 230/400 VAC
(3 x 220/380 VAC)
(3 x 240/415 VAC)

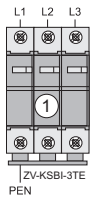

TN-S-System
3 x 230/400 VAC
(3 x 220/380 VAC)
(3 x 240/415 VAC)

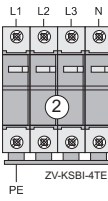

TT-System
3 x 230 VAC
(3 x 220 VAC)



TN-S-/TT-System
3 x 230/400 VAC
(3 x 220/380 VAC)
(3 x 240/415 VAC)



TN-S-System
1 x 230 VAC
(1 x 220 VAC)
(1 x 240 VAC)

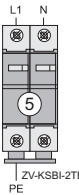

TN-S-/TT-System
1 x 230 VAC
(1 x 220 VAC)
(1 x 240 VAC)

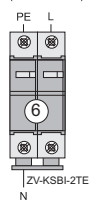

TN-S-/TT-System
1 x 230 VAC
(1 x 220 VAC) (1 x 240 VAC)

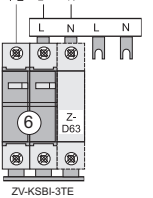

TN-S-/TT-System
230 VAC

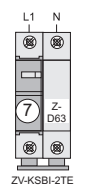

TN-S-/TT-System
3 x 230/400 VAC

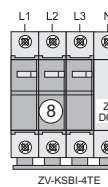

		①	②	③	④	
	IEC 60364-5-53 Clause 534	SPET2-280/3	SPET2-280/4	—	SPET2-335/3+NPE	
(A)	ÖVE ÖNORM E8101	SPET2-335/3	SPET2-335/4	—	SPET2-335/3+NPE	
(D)	VDE V 0100-534	SPET2-280/3	SPET2-280/4	—	SPET2-335/3+NPE	
(N)		SPET2-280/3	SPET2-280/4	SPET2-280/3	—	

		⑤	⑥	⑦	⑧	
	IEC 60364-5-53 Clause 534	SPET2-280/2	SPET2-335/1+NPE	—	—	
(A)	ÖVE ÖNORM E8101	SPET2-335/2	SPET2-335/1+NPE	—	—	
(D)	VDE V 0100-534	SPET2-280/2	SPET2-335/1+NPE	—	—	
(F)	UTE C 20-443	—	—	SPET2-280/1	SPET2-280/3	

Description Auxiliary switch for Surge arrester ASAUXSC-SPM

- Field of application:
For mounting onto surge protective devices for external defect message transmission
- Design basically in accordance with IEC 60947-5-1
- Can be mounted subsequently
- Suitable with SPBT12, SPCT2, SPET2, SPDT3, SP-B+C

Technical Data

	ASAUXSC-SPM
Electrical	
Rated insulation voltage	250 V
Rated frequency	50 Hz
Switching contact	1 CO
Minimum voltage per contact	24 VAC
Rated operational current AC12	2 A / 250 VAC
Maximum back-up fuse	2 A gL
Overvoltage category	IV
Pollution degree	2
Mechanical	
Frame size	45 mm
Device height	80 mm
Device width	8.8 mm
Mounting	Screw-mounting
Degree of protection, built-in	IP40
Terminal protection	finger and hand touch safe according to DGUV VS3, EN 50274
Upper and lower terminals	lift terminals
Terminal capacity	2 x 2.5 mm ²
Tightening torque of terminal screws	0.8 - 1 Nm

Connection diagram



Dimensions (mm)

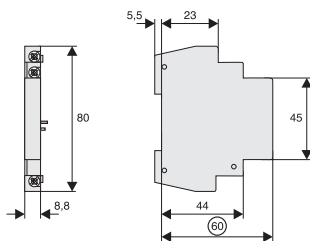

Application Examples

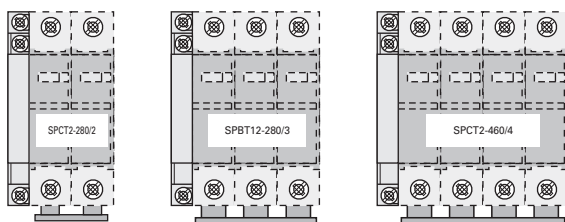

Description Lead-Through Terminal for Surge Protective Devices, SPD-type 2 (Surge Protective Class C), ASLTT-63

- The lead-through terminal permits orderly wiring of SPDs types 2 (Surge Protective Class C).
It serves as lead-through terminal in circuits requiring vertical connections from the upper to the lower SPD connection level.
- 1pole
- Suitable for standard busbar connection to EATON switchgear

Technical Data

	ASLTT-63
Electrical	
Rated voltage	690 V AC/DC
Rated current	63 A
Rated frequency	50 Hz
Mechanical	
Frame size	45 mm
Device height	80 mm
Device width	17.5 mm
Mounting	quick fastening on DIN rail IEC/EN 60715
Degree of protection, built-in	IP40
Terminal protection	finger and hand touch safe according to DGUV VS3, EN 50274
Upper and lower terminals	Lift- and Maulklemme
Terminal capacity	1 - 25 mm ²
Busbar thickness	0.8 - 2 mm
Tightening torque of terminal screws	2.4 - 3 Nm

Connection diagram



Dimensions (mm)

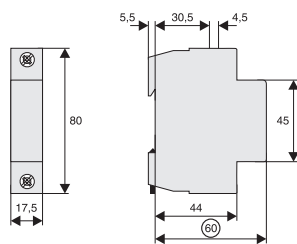

Application Example / Connection type 2 according to IEC 60364-5-53 Clause 534

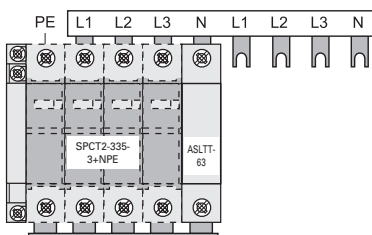

sg03213



Beschreibung

- Test class 3 tested SPD
- Suitable to protect sensitive devices in your installation
- To be placed on a DIN-rail in the near vicinity of sensitive devices
- Auxiliary contact available as accessory

Types

SPD „NPE“

- Galvanic separated SPD path between neutral and protective earth
- Suitable to be placed behind an RCD due to the 1+1 connection

Test class 3 tested SPD, SPDT3

Poles	Max. Continuous Operating Voltage U_c	Type Designation	Article No.	Units per package
-------	--	---------------------	-------------	----------------------

Surge arrester SPDT3

Single phase supply / 1+1 connection

1pole+N	335 VAC	SPDT3-335-1+NPE	170487	1/60
---------	---------	-----------------	--------	------

Single phase supply / 2+0 connection

2pole	280 VAC	SPDT3-280/2	170485	1/60
-------	---------	-------------	--------	------

SG03213



Max. Continuous Operating Voltage U_c	Type Designation	Article No.	Units per package
--	---------------------	-------------	----------------------

Surge arrester SPDT3, Insert

Insert (1pole/path)

280 VAC	SPDT3-280	170484	2/120
335 VAC	SPDT3-335	170486	2/120



sg03413



Description Surge Protective Class T3

- Field of application:
For fine protection of user equipment against transient overvoltage
- For mounting on DIN rails in distribution boxes for electrical installation
- No decoupling from upstream surge protection in the low voltage distribution system required
- Test class III according to IEC 61643-11
- SPD-type T3 according to EN 61643-11
- Suitable for high back-up fuse 63 A gL / C 63
- Auxiliary switch ASAXSC-SPM for remote message transmission can be mounted onto the device

Technical Data

		SPDT3-335-1+NPE		SPDT3-280/2	
Electrical					
Mechanical coding			yx		xx
Responding time (rate of voltage rise 5 kV/μs)		L-N/N-PE/L-PE	< 25ns/< 100ns/< 100ns	L1-L2(N)/L2(N)-PE/L1-PE	< 25ns
Max. continuous operating voltage	U_C	L-N/N-PE	335VAC/260VAC	L1-L2(N)/L2(N)-PE	280VAC
TOV test value	U_T				
5 s		L-N/L-PE	348VAC/416VAC	L-N/L-PE	348VAC/416VAC
200 ms		N-PE	1200VAC	N-PE	1200VAC
Rated frequency			50 Hz		50 Hz
Open circuit voltage	U_{OC}	L-N/N-PE/L-PE	6kV	L1-L2(N)/L2(N)-PE/L1-PE	6kV
Voltage protection level at UOC	U_p	L-N/N-PE/L-PE	$\leq 1000V/\leq 1500V/\leq 1000V$	L1-L2(N)/L2(N)-PE	$\leq 900V$
Nominal discharge current (8/20) μs	I_n	L-N/N-PE/L-PE	2.5kA	L1-L2(N)/L2(N)-PE	5kA
Voltage protection level at I_n	U_p	L-N/N-PE/L-PE	$\leq 1000V/\leq 1500V/\leq 1000V$	L1-L2(N)/L2(N)-PE	$\leq 950V$
Max. discharge current (8/20) μs	I_{max}	L-N/N-PE/L-PE	10kA	L1-L2(N)/L2(N)-PE/L1-PE	10kA
Follow current interrupt rating	I_{fi}	N-PE	100 $A_{r.m.s.}$		—
Maximum back-up fuse			 $\leq 125 AgL$ 50 $kA_{r.m.s.}$		
Maximum short-circuit current				 $\leq C63$ 10 $kA_{r.m.s.}$	

Connection diagram



Mechanical

Mechanical coding of base	yx	xx
Frame size	45 mm	45 mm
Device height	80 mm	80 mm
Device width	35 mm	35 mm
Weight	220 g	220 g
Permitted ambient temperature	-40°C to +70°C	-40°C to +70°C
Degree of protection	IP20	IP20
Upper and lower lift terminal capacity	1 - 25 mm ²	1 - 25 mm ²
Upper and lower open mouthed terminals for busbar thickness up to	1.5 mm	1.5 mm
Tightening torque of terminal screws	2.4 - 3 Nm	2.4 - 3 Nm
Quick fastening on DIN rail according to	IEC/EN 60715	IEC/EN 60715

Dimensions (mm)

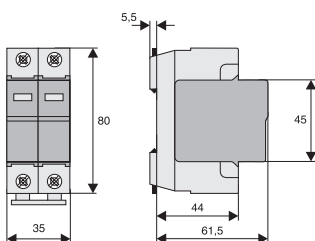

Application Examples

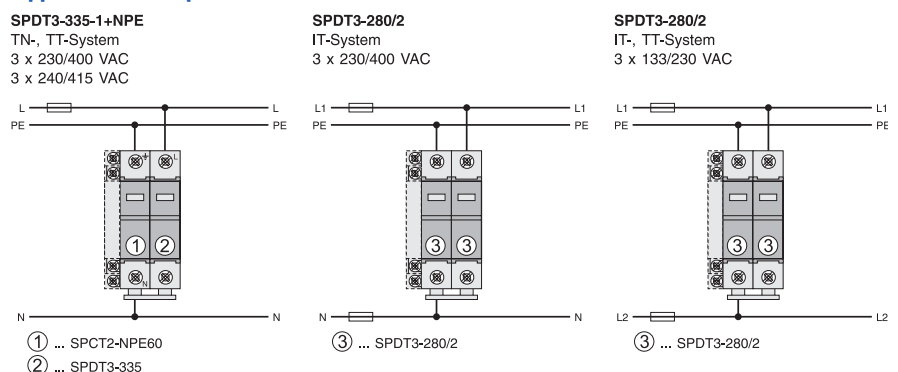







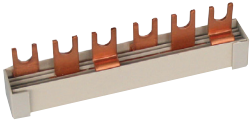







Busbar

Used for	Type Designation	Article No.	Units per package
Busbar Z-GV-16/3P-3TE/6			
for SPBT12 & SPCT2	Z-GV-16/3P-3TE/6	267511	12/240

WA_SG11202



Poles	Type Designation	Article No.	Units per package
Busbar ZV-KSBI for SPBT12 & SPCT2			
	2MU	ZV-KSBI-2MU	263961 10/600
	3MU	ZV-KSBI-3TE	263962 10/600
	3MU	ZV-KSBI-3TE/S	263963 10/600
	2MU+1.5MU	ZV-KSBI-3TE+HI	112370 50/150
	4MU	ZV-KSBI-4TE	263964 10/600
	5MU	ZV-KSBI-5TE	263965 10/200
	5MU	ZV-KSBI-5TE/N	263966 10/200
	2MU+3x1.5MU	ZV-KSBI-5TE+HI	112371 50/150
	6MU	ZV-KSBI-6TE	113118 50/500
	7MU	ZV-KSBI-7TE	263967 50/500
	7MU	ZV-KSBI-7TE/S	263968 10/100
	7MU	ZV-KSBI-7TE/N	263969 10/100
	9MU	ZV-KSBI-9TE/N	266874 50/500
	11MU	ZV-KSBI-11MU	263970 50/500

Description busbar ZV-KSBI

- With the ZV KSBI busbar bracket you can realize the common combinations of arrestors.
- Used for SPB-..., SPC-..., Z-D63
- The rated cross-section of the ZV-KSBI bridge metals is 16 mm²
- The busbar mounting bracket can be shortened

Technical Data

ZV-KSBI	
Electrical	
Rated voltage	230/400 V, 50/60 Hz
Rated current	63 A
Mechanical	
Busbar cross section	16 mm ² Cu

Design

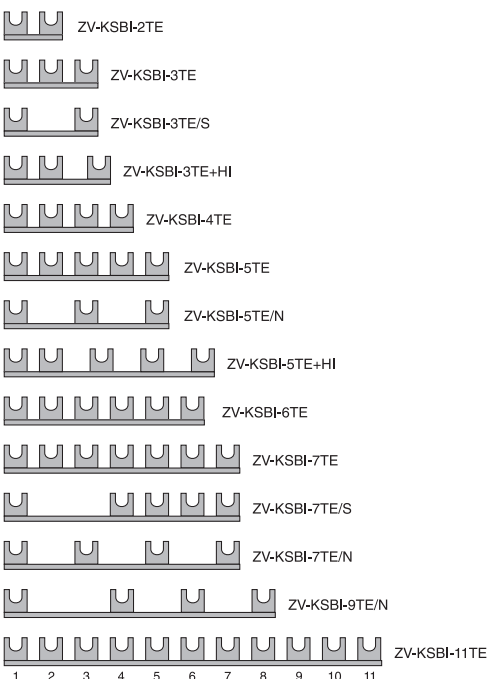

SPPVR Family Overview

The SPPVR family of surge protection devices (SPD) is Eaton's answer to the rising need for safe and reliable PV installations in residential and commercial applications.

Powerful protection for your inverter is the first step to ensure a long lifetime of your equipment and inverter: Surge protection ensures that your system is not damaged by any overvoltage event that this happening on the DC side of your PV application.

With the SPPVR family Eaton enables you to establish a PV application from one source, specialized for decades on providing you safety above the standard in a sustainable way.

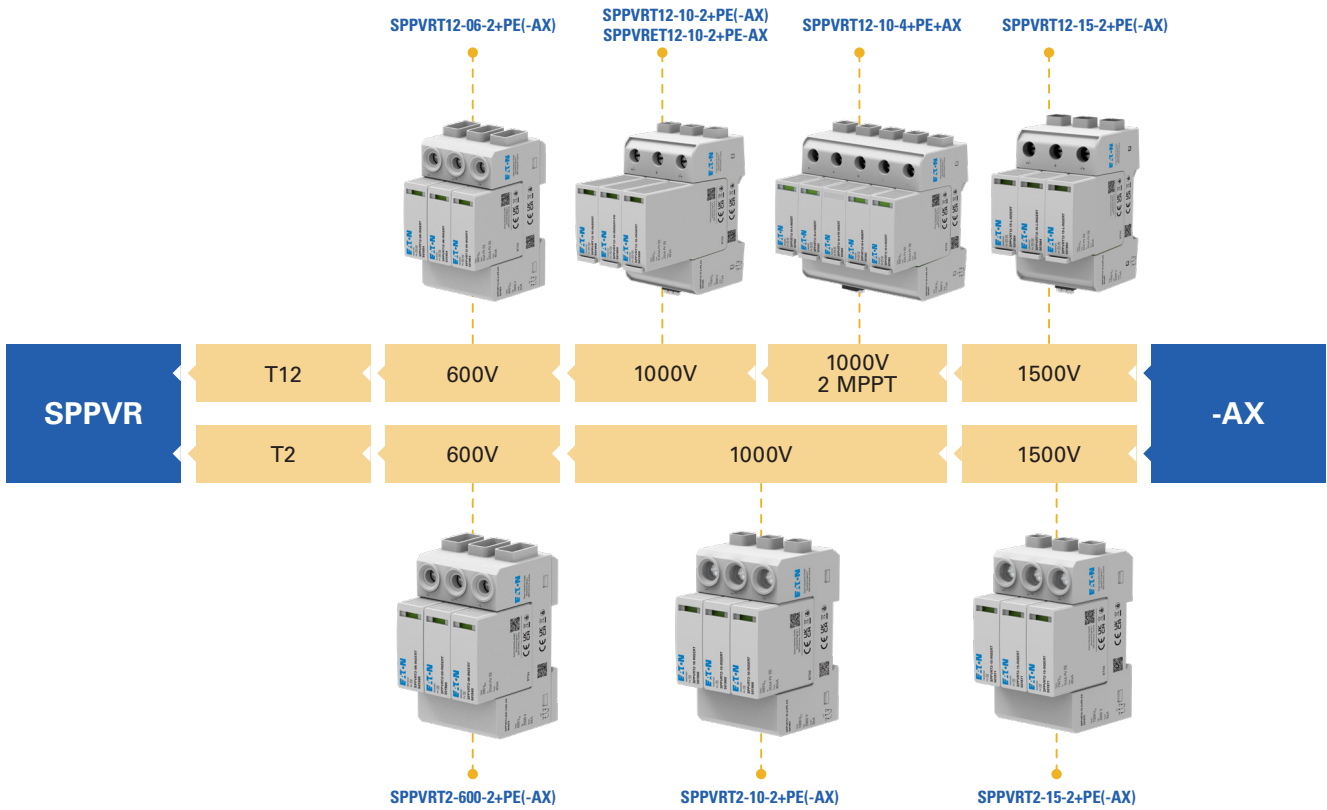

Class 1 and 2 combined tested DC SPDs for photovoltaic systems

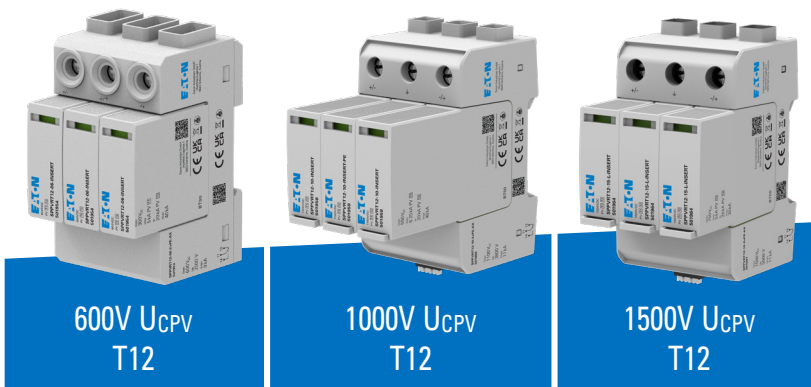

Description

- DC Surge Protection Devices (SPD) for photovoltaic systems
- Versatile product range covering 600 - 1500 V DC applications
- Test class 1 and 2 combined devices for applications with a risk of damage from direct lightning strikes
- Remote contact available for all types (-AX)

Types

SPPVR – “AX”

- These types come with an auxiliary contact

Test class 1 and 2 combined SPD for 600 V DC applications

- Powerful yet compact solution for 600 V DC applications
- Perfect fit for enclosures such as CI-Safety
- Replacement plugs available
- Available as -AX type which comes already equipped with an auxiliary contact
- Operational temperature range up to 85°C to perform well under harsh conditions

U_{CPV} (Voltage per MPPT)	Test class	Type Designation	Article No.	Units per package (Pcs.)
-AX type with integrated auxiliary contact				
600 V	T12	SPPVRT12-06-2+PE	EP-501952	1
600 V	T12	SPPVRT12-06-2+PE-AX	EP-501953	1

EP-501953_L



Replacement inserts for SPPVRT12-06-2+PE(-AX)

(+) / (-) / PE	SPPVRT12-06-INSERT	EP-501954	1
----------------	--------------------	-----------	---

EP-501954_L



Technical Data

		SPPVRT12-06-2+PE(-AX)
General data		
Standards/regulations		IEC 61643-31:2018 EN 61643-31:2019
Pollution degree		2
Housing material		UL 94 V-0 (Thermoplastic)
Degree of protection		IP20
Ambient temperature (operation)	Ta	-40°C up to +85 °C
Permissible humidity (operation)	RH	5% up to 95%
Max. altitude		2000 m
Electric data		
Mode of Protection		(+) – PE / (-) – PE / (+) – (-)
Number of Ports		1
Nominal Voltage	U_{CPV}	600 V DC
Nominal Discharge Current (8/20 μ s)	I_n	20 kA
Maximum Discharge Current (8/20 μ s)	I_{max}	40 kA
Impulse Discharge Current (10/350 μ s)	I_{imp}	5 kA
Total Discharge Current (8/20 μ s)	I_{total}	40 kA
Total Discharge Current (10/350 μ s)	I_{total}	5 kA
Rated short circuit current rating	I_{SCPV}	9 kA
Specific energy	W/R	1.56 kJ/ Ω
Charge	Q	1.25 As
Response Time	tA	< 25 ns
Voltage protection level	(+) - (-)	< 2.5 kV
	(+) - PE	< 2.5 kV
	(-) – PE	< 2.5 kV
Thermal Protection		Yes (integrated)

SPPVRT12-06-2+PE(-AX)

Electric data (-AX contact)

Switching capabilities	AC	1 A @ 120 – 250 V
	DC	0.5 A @ 12 – 48 V
Permissible conductor cross section (max)	Solid	1.5 mm ²

Technical data

Mounting	Din-Rail (35 mm, EN 60715)	
Connections	1x (+), 1x (-), 1x PE	
Permissible conductor cross section (max)	Solid	6 mm ²
	Stranded	35 mm ²
	Flexible	25 mm ²

Dimensions (mm)

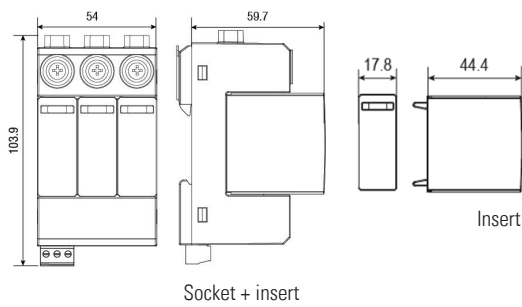

Internal Configuration

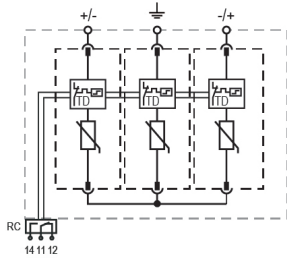

Test class 1 and 2 combined SPD for 1000 V DC applications

- Powerful yet compact solution for 1000 V DC applications
- High I_{imp} / I_{total} rating to omit the need for a risk assessment of the application
- Perfect fit for enclosures such as CI-Safety
- Replacement plugs available
- Available as -AX type which comes already equipped with an auxiliary contact
- Operational temperature range up to 85°C to perform well under harsh conditions
- Could be mounted in:
 - xEnergy Safety Ci: Types AV...-200
 - xEnergy Basic EWK: Types EWK-G...
 - xComfort IKA: Types IKA-1/12... or bigger, only when mounted in middle position

U_{CPV} (Voltage per MPPT)	Test class	Type Designation	Article No.	Units per package (Pcs.)
---------------------------------	------------	---------------------	-------------	-----------------------------

-AX type with integrated auxiliary contact



1000 V	T12	SPPVRT12-10-2+PE	EP-501955	1
1000 V	T12	SPPVRT12-10-2+PE-AX	EP-501956	1
1000 V	T12	SPPVRET12-10-2+PE	EP-502585	1
1000 V	T12	SPPVRET12-10-2+PE-AX	EP-502586	1

Replacement inserts for SPPVRT12-10-2+PE(-AX)

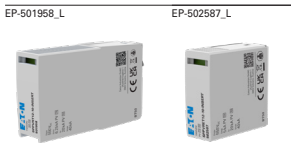

(+) / (-)		SPPVRT12-10-INSERT	EP-501958	1
PE		SPPVRT12-10-INSERT-PE	EP-501959	1
(+) / (-)		SPPVRET12-10-2-INSERT	EP-502587	1

Technical Data

		SPPVRT12-10-2+PE(-AX) / SPPVRET12-10-2+PE(-AX)	
General data			
Standards/regulations		IEC 61643-31:2018 EN 61643-31:2019	
Pollution degree		2	
Housing material		UL 94 V-0 (Thermoplastic)	
Degree of protection		IP20	
Ambient temperature (operation)	Ta	-40°C up to +85 °C	
Permissible humidity (operation)	RH	5% up to 95%	
Max. altitude		4000 m	
Electric data			
Mode of Protection		(+) – PE / (-) – PE / (+) – (-)	
Number of Ports		1	
Nominal Voltage	U_{CPV}	1100 V DC	
Nominal Discharge Current (8/20 μ s)	I_n	20 kA	
Maximum Discharge Current (8/20 μ s)	I_{max}	40 kA	
Impulse Discharge Current (10/350 μ s)	I_{imp}	6.25 kA (5 kA for SPPVRET12-10-2+PE-AX)	
Total Discharge Current (8/20 μ s)	I_{total}	50 kA	
Total Discharge Current (10/350 μ s)	I_{total}	12.5 kA	
Rated short circuit current rating	I_{SCPV}	11 kA	
Specific energy	W/R	9.77 kJ/ Ω	
Charge	Q	3.12 As	
Response Time	t _A	< 25 ns	
Voltage protection level		(+) - (-)	< 3.8 kV
		(+) - PE	< 3.8 kV
		(-) – PE	< 3.8 kV
Thermal Protection		Yes (integrated)	

SPPVRT12-10-2+PE(-AX) / SPPVRET12-10-2+PE(-AX)

Electric data (-AX contact)

Switching capabilities	AC	1 A @ 120 – 250 V
	DC	0.5 A @ 12 – 48 V
Permissible conductor cross section (max)	Solid	1.5 mm ²

Technical data

Mounting	Din-Rail (35 mm, EN 60715)	
Connections	1x (+), 1x (-), 1x PE	
Permissible conductor cross section (max)	Solid	35 mm ²
	Stranded	35 mm ²
	Flexible	25 mm ²

Dimensions (mm)

SPPVRT12-10-...

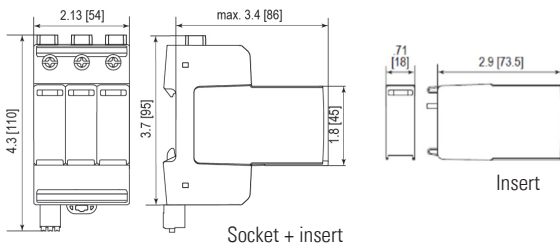

SPPVRET12-10-...

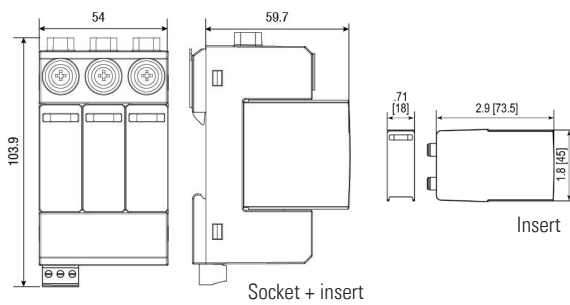

Internal Configuration

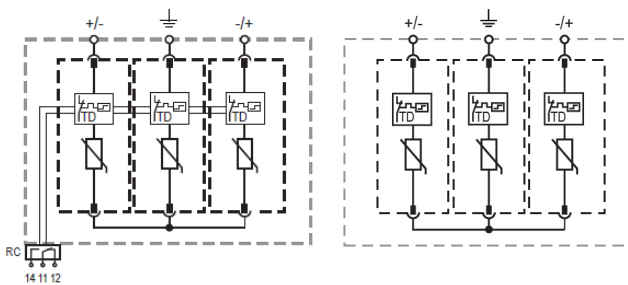

Test class 1 and 2 combined SPD for 1500 V DC applications

- Powerful yet compact solution for 1500 V DC applications
- High I_{imp} / I_{total} rating to omit the need for a risk assessment of the application
- Perfect fit for enclosures such as CI-Safety
- Replacement plugs available
- Available as -AX type which comes already equipped with an auxiliary contact
- Operational temperature range up to 85°C to perform well under harsh conditions

U_{CPV} (Voltage per MPPT)	Test class	Type Designation	Article No.	Units per package (Pcs.)
---------------------------------	------------	---------------------	-------------	-----------------------------

-AX type with integrated auxiliary contact

EP-501961_L



1500 V	T12	SPPVRT12-15-2+PE	EP-501960	1
1500 V	T12	SPPVRT12-15-2+PE-AX	EP-501961	1

Replacement inserts for SPPVRT12-15-2+PE(-AX)

EP-501964_L



(+) / (-) / PE		SPPVRT12-15-L-INSERT	EP-501964	1
----------------	--	----------------------	-----------	---

Technical Data

SPPVRT12-15-2+PE(-AX)

General data

Standards/regulations		IEC 61643-31:2018 EN 61643-31:2019
Pollution degree		2
Housing material		UL 94 V-0 (Thermoplastic)
Degree of protection		IP20
Ambient temperature (operation)	Ta	-40°C up to +85 °C
Permissible humidity (operation)	RH	5% up to 95%
Max. altitude		4000 m

Electric data

Mode of Protection		(+) – PE / (-) – PE / (+) – (-)
Number of Ports		1
Nominal Voltage	U_{CPV}	1500 V DC
Nominal Discharge Current (8/20 μ s)	I_n	20 kA
Maximum Discharge Current (8/20 μ s)	I_{max}	30 kA
Impulse Discharge Current (10/350 μ s)	I_{imp}	5 kA
Total Discharge Current (8/20 μ s)	I_{total}	40 kA
Total Discharge Current (10/350 μ s)	I_{total}	5 kA
Rated short circuit current rating	I_{SCPV}	11 kA
Specific energy	W/R	6.25 kJ/ Ω
Charge	Q	2.5 As
Response Time	t_A	< 25 ns
Voltage protection level	(+) - (-)	< 5 kV
	(+) - PE	< 5 kV
	(-) – PE	< 5 kV
Thermal Protection		Yes (integrated)

SPPVRT12-15-2+PE(-AX)

Electric data (-AX contact)

Switching capabilities	AC	1 A @ 120 – 250 V
	DC	0.5 A @ 12 – 48 V
Permissible conductor cross section (max)	Solid	1.5 mm ²

Technical data

Mounting	Din-Rail (35 mm, EN 60715)	
Connections	1x (+), 1x (-), 1x PE	
Permissible conductor cross section (max)	Solid	35 mm ²
	Stranded	35 mm ²
	Flexible	25 mm ²

Dimensions (mm)

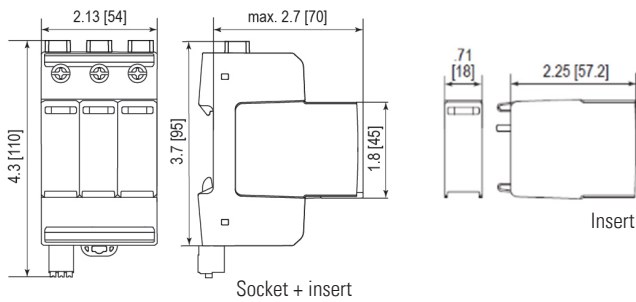

Internal Configuration

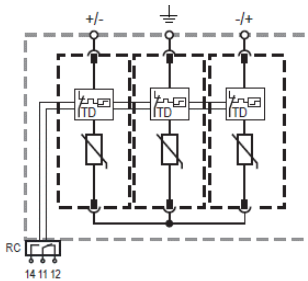



Description

- DC Surge Protection Device (SPD) for photovoltaic systems
- One SPD protects 2 MPPT, offering a compact yet powerful solution
- Test class 1 and 2 combined tested device for applications with a risk of damage from direct lightning strikes
- Remote contact integrated

Type SPPVR-“AX”

- These types come with an auxiliary contact

Test class 1 and 2 combined 2 MPPT SPD for 1000 V DC applications

- Powerful yet compact solution for 1000 V DC applications
- Space saving solution to protect 2 MPPT in one protection device
- Replacement plugs available for easy replacement
- This type already comes equipped with an auxiliary contact

U_{CPV} (Voltage per MPPT)	Test class	Type Designation	Article No.	Units per package (Pcs.)
---------------------------------	------------	---------------------	-------------	-----------------------------

-AX type with integrated auxiliary contact

EP-501957_L



1100 V	T12	SPPVRT12-10-4+PE+AX	EP-501957	1
--------	-----	---------------------	-----------	---

Replacement inserts for SPPVRT12-10-4+PE+AX

EP-501962_L



(+) / (-)		SPPVRT12-10-4-INSERT	EP-501962	1
PE		SPPVRT12-10-4-PE-INSERT	EP-501963	1

Technical Data

		SPPVRT12-10-4+PE+AX	
General data			
Standards/regulations		IEC 61643-31:2018 EN 61643-31:2019	
Pollution degree		2	
Housing material		UL 94 V-0 (Thermoplastic)	
Degree of protection		IP20	
Ambient temperature (operation)	Ta	-40°C up to +70 °C	
Permissible humidity (operation)	RH	5% up to 95%	
Max. altitude		4000 m	
Electric data			
Mode of Protection		(+) – PE / (-) – PE / (+) – (-)	
Number of Ports		1	
Nominal Voltage	U_{CPV}	1100 V DC	
Nominal Discharge Current (8/20 μ s)	I_n	20 kA	
Maximum Discharge Current (8/20 μ s)	I_{max}	40 kA	
Impulse Discharge Current (10/350 μ s)	I_{imp}	5 kA	
Total Discharge Current (8/20 μ s)	I_{total}	50 kA	
Total Discharge Current (10/350 μ s)	I_{total}	10 kA	
Rated short circuit current rating	I_{SCPV}	11 kA	
Specific energy	W/R	6.25 kJ/ Ω	
Charge	Q	2.5 As	
Response Time	t_A	< 25 ns	
Voltage protection level		(+) - (-)	< 3.8 kV
		(+) - PE	< 3.8 kV
		(-) – PE	< 3.8 kV
Thermal Protection		Yes (integrated)	

SPPVRT12-10-4+PE+AX

Electric data (-AX contact)

Switching capabilities	AC	1 A @ 120 – 250 V
	DC	0.5 A @ 12 – 48 V
Permissible conductor cross section (max)	Solid	1.5 mm ²

Technical data

Mounting	Din-Rail (35 mm, EN 60715)	
Connections	2x (+), 2x (-), 1x PE	
Permissible conductor cross section (max)	Solid	35 mm ²
	Stranded	35 mm ²
	Flexible	25 mm ²

Dimensions (mm)

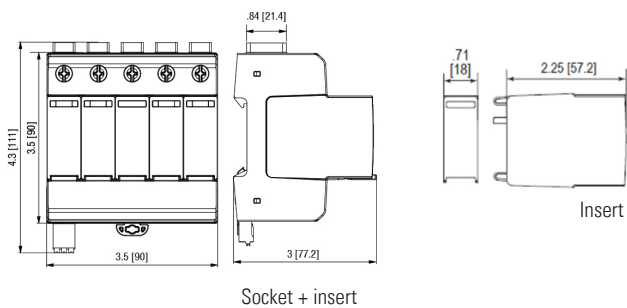

Internal Configuration

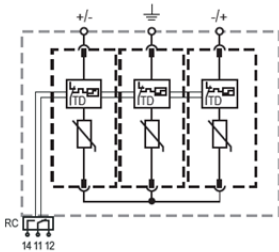

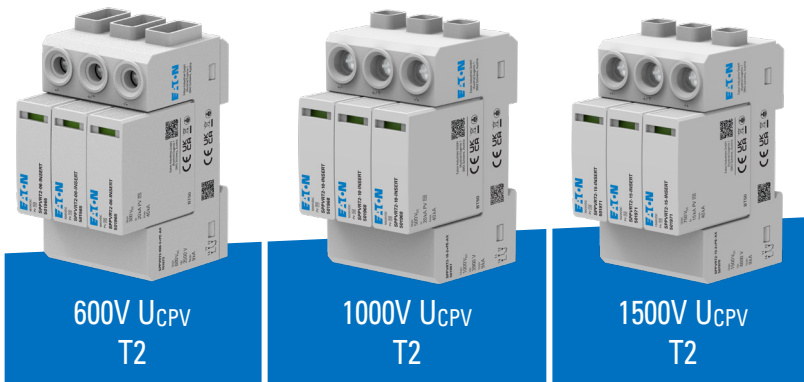

Description

- DC Surge Protection Devices (SPD) for photovoltaic systems
- Versatile product range covering 600 - 1500 V DC applications
- Class 2 tested devices for the majority of applications
- Remote contact available for all types (-AX)

Types

SPPVR – “AX”

- These types come with an auxiliary contact

Test class 2 SPD for 600 V DC applications

- Powerful yet compact solution for 600 V DC applications
- Perfect fit for enclosures such as IKA, CI-Safety or similar
- Replacement plugs available
- Available as -AX type which comes already equipped with an auxiliary contact
- Operational temperature range up to 85°C to perform well under harsh conditions

U_{CPV} (Voltage per MPPT)	Test class	Type Designation	Article No.	Units per package (Pcs.)
---------------------------------	------------	---------------------	-------------	-----------------------------

-AX type with integrated auxiliary contact

EP-501973_L



600 V	T2	SPPVRT2-600-2+PE	EP-501972	1
600 V	T2	SPPVRT2-600-2+PE-AX	EP-501973	1

Replacement inserts for SPPVRT2-600-2+PE(-AX)

EP-501965_L



(+) / (-) / PE		SPPVRT2-06-INSERT	EP-501965	1
----------------	--	-------------------	-----------	---

Technical Data

		SPPVRT2-600-2+PE(-AX)
General data		
Standards/regulations		IEC 61643-31:2018 EN 61643-31:2019
Pollution degree		2
Housing material		UL 94 V-0 (Thermoplastic)
Degree of protection		IP20
Ambient temperature (operation)	Ta	-40°C up to +85 °C
Permissible humidity (operation)	RH	5% up to 95%
Max. altitude		2000 m
Electric data		
Mode of Protection		(+) – PE / (-) – PE / (+) – (-)
Number of Ports		1
Nominal Voltage	U_{CPV}	600 V DC
Nominal Discharge Current (8/20 μ s)	I_n	20 kA
Maximum Discharge Current (8/20 μ s)	I_{max}	40 kA
Total Discharge Current (8/20 μ s)	I_{total}	40 kA
Rated short circuit current rating	I_{SCPV}	9 kA
Response Time	t_A	< 25 ns
Voltage protection level	(+) - (-)	< 2.5 kV
	(+) - PE	< 2.5 kV
	(-) – PE	< 2.5 kV
Thermal Protection		Yes (integrated)

SPPVRT2-600-2+PE-(AX)

Electric data (-AX contact)

Switching capabilities	AC	1 A @ 120 – 250 V
	DC	0.5 A @ 12 – 48 V
Permissible conductor cross section (max)	Solid	1.5 mm ²

Technical data

Mounting	Din-Rail (35 mm, EN 60715)	
Connections	1x (+), 1x (-), 1x PE	
Permissible conductor cross section (max)	Solid	6 mm ²
	Stranded	35 mm ²
	Flexible	25 mm ²

Dimensions (mm)

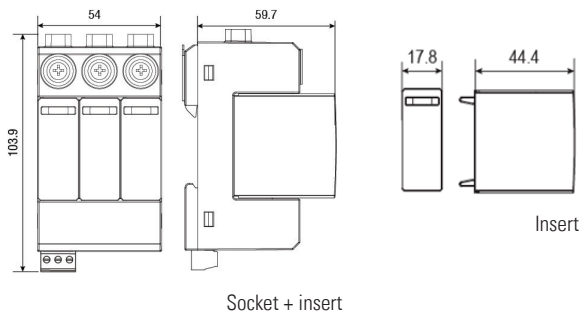

Internal Configuration

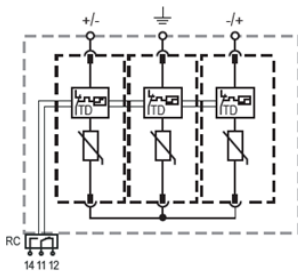

Test class 2 SPD for 1000 V DC applications

- Powerful yet compact solution for 1000 V DC applications
- Perfect fit for enclosures such as IKA, CI-Safety or similar
- Replacement plugs available
- Available as -AX type which comes already equipped with an auxiliary contact
- Operational temperature range up to 85°C to perform well under harsh conditions

U_{CPV} (Voltage per MPPT)	Test class	Type Designation	Article No.	Units per package (Pcs.)
---------------------------------	------------	---------------------	-------------	-----------------------------

-AX type with integrated auxiliary contact

EP-501967_L



1000 V	T2	SPPVRT2-10-2+PE	EP-501966	1
1000 V	T2	SPPVRT2-10-2+PE-AX	EP-501967	1

Replacement inserts for SPPVRT2-10-2+PE(-AX)

EP-501968_L



(+) / (-) / PE		SPPVRT2-10-INSERT	EP-501968	1
----------------	--	-------------------	-----------	---

SPPVRT2-10-2+PE(-AX)

General data

Standards/regulations		IEC 61643-31:2018 EN 61643-31:2019
Pollution degree		2
Housing material		UL 94 V-0 (Thermoplastic)
Degree of protection		IP20
Ambient temperature (operation)	Ta	-40°C up to +85 °C
Permissible humidity (operation)	RH	5% up to 95%
Max. altitude		2000 m

Electric data

Mode of Protection		(+) – PE / (-) – PE / (+) – (-)
Number of Ports		1
Nominal Voltage	U_{CPV}	1000 V DC
Nominal Discharge Current (8/20 μ s)	I_n	20 kA
Maximum Discharge Current (8/20 μ s)	I_{max}	40 kA
Total Discharge Current (8/20 μ s)	I_{total}	40 kA
Rated short circuit current rating	I_{SCPV}	9 kA
Response Time	t_A	< 25 ns
Voltage protection level	(+) - (-)	< 3.9 kV
	(+) - PE	< 3.9 kV
	(-) – PE	< 3.9 kV
Thermal Protection		Yes (integrated)

SPPVRT2-10-2+PE(-AX)

Electric data (-AX contact)

Switching capabilities	AC	1 A @ 120 – 250 V
	DC	0.5 A @ 12 – 48 V
Permissible conductor cross section (max)	Solid	1.5 mm ²

Technical data

Mounting	Din-Rail (35 mm, EN 60715)	
Connections	1x (+), 1x (-), 1x PE	
Permissible conductor cross section (max)	Solid	6 mm ²
	Stranded	35 mm ²
	Flexible	25 mm ²

Dimensions (mm)

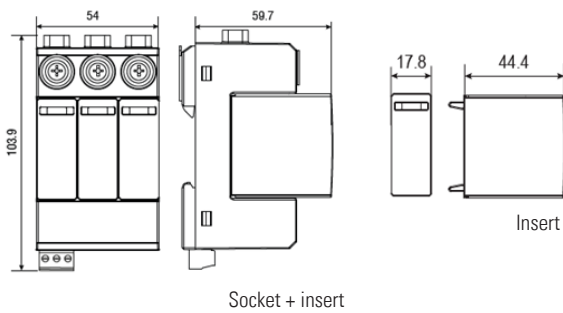

Internal Configuration

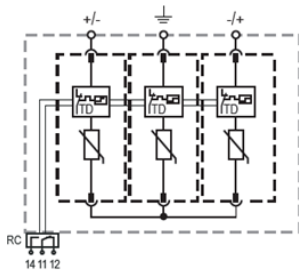

Test class 2 SPD for 1500 V DC applications

- Powerful yet compact solution for 1500 V DC applications
- Perfect fit for enclosures such as IKA, CI-Safety or similar
- Replacement plugs available
- Available as -AX type which comes already equipped with an auxiliary contact
- Operational temperature range up to 85°C to perform well under harsh conditions

U_{CPV} (Voltage per MPPT)	Test class	Type Designation	Article No.	Units per package (Pcs.)
---------------------------------	------------	---------------------	-------------	-----------------------------

-AX type with integrated auxiliary contact

EP-501970_L



1500 V	T2	SPPVRT2-15-2+PE	EP-501969	1
1500 V	T2	SPPVRT2-15-2+PE-AX	EP-501970	1

Replacement inserts for SPPVRT2-15-2+PE(-AX)

EP-501971_L



(+) / (-) / PE		SPPVRT2-15-INSERT	EP-501971	1
----------------	--	-------------------	-----------	---

SPPVRT2-15-2+PE(-AX)

General data

Standards/regulations		IEC 61643-31:2018 EN 61643-31:2019
Pollution degree		2
Housing material		UL 94 V-0 (Thermoplastic)
Degree of protection		IP20
Ambient temperature (operation)	Ta	-40°C up to +85 °C
Permissible humidity (operation)	RH	5% up to 95%
Max. altitude		2000 m

Electric data

Mode of Protection		(+) – PE / (-) – PE / (+) – (-)
Number of Ports		1
Nominal Voltage	U_{CPV}	1500 V DC
Nominal Discharge Current (8/20 μ s)	I_n	20 kA
Maximum Discharge Current (8/20 μ s)	I_{max}	40 kA
Total Discharge Current (8/20 μ s)	I_{total}	40 kA
Rated short circuit current rating	I_{SCPV}	9 kA
Response Time	t_A	< 25 ns
Voltage protection level		(+) - (-) < 4.8 kV (+) - PE < 4.8 kV (-) – PE < 4.8 kV
Thermal Protection		Yes (integrated)

SPPVRT2-15-2+PE(-AX)

Electric data (-AX contact)

Switching capabilities	AC	1 A @ 120 – 250 V
	DC	0.5 A @ 12 – 48 V
Permissible conductor cross section (max)	Solid	1.5 mm ²

Technical data

Mounting	Din-Rail (35 mm, EN 60715)	
Connections	1x (+), 1x (-), 1x PE	
Permissible conductor cross section (max)	Solid	6 mm ²
	Stranded	35 mm ²
	Flexible	25 mm ²

Dimensions (mm)

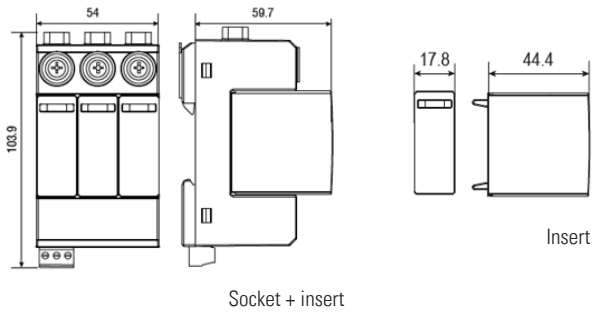

Internal Configuration

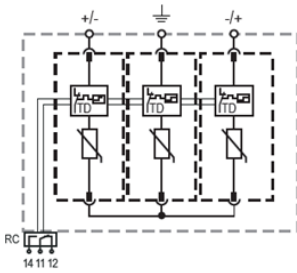

Eaton's electrical business is a global leader with deep regional application expertise in power distribution and circuit protection; power quality, backup power and energy storage; control and automation; life safety and security; structural solutions; and harsh and hazardous environment solutions. Through end-to-end services, channel and an integrated digital platform & insights Eaton is powering what matters across industries and around the world, helping customers solve their most critical electrical power management challenges.

For more information, visit [Eaton.com](https://www.eaton.com).



Eaton Industries (Austria) GmbH
Schedygasse 42
1210 Vienna
Austria

Eaton
EMEA Headquarters
Route de la Longeraie 7
1110 Morges, Switzerland

© 2023 Eaton
All Rights Reserved
Publication No. CA010001EN
Article number 301969-MK
October 2024

Changes to the products, to the information contained in this document, and to prices are reserved; as are errors and omissions. Only order confirmations and technical documentation by Eaton is binding. Photos and pictures also do not warrant a specific layout or functionality. Their use in whatever form is subject to prior approval by Eaton. The same applies to trademarks (especially Eaton, Moeller, and Cutler-Hammer). The Terms and Conditions of Eaton apply, as referenced on Eaton Internet pages and Eaton order confirmations.

Eaton is a registered trademark.

All other trademarks are property of their respective owners.

