



Powering Business Worldwide

Power Defense™

Circuit Breaker Accessory

For PDG1 Frame

IL012165EN H03

PDG1 Box Terminal (Steel) 125 amps,
AWG 14-3/0, 3 poles
Cat. no. PDG1X3T125
Style no. 66A3613G17
Quantity - 3

Instructions for assembling collar
to circuit breaker

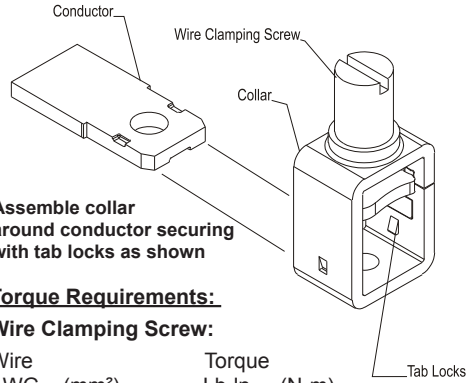

Assemble collar
around conductor securing
with tab locks as shown

Torque Requirements:

Wire Clamping Screw:

Wire AWG (mm ²)	Torque Lb-In (N-m)
14-10 (2.5-6)	35 (4.0)
8 (10)	40 (4.5)
6-4 (16-25)	45 (5.1)
3-3/0 (35-95)	50 (5.6)

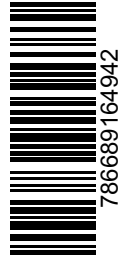

Powering Business Worldwide

Power Defense™

Circuit Breaker Accessory

For PDG1 Frame

IL012165EN H03

PDG1 Box Terminal (Steel) 125 amps,
AWG 14-3/0, 3 poles
Cat. no. PDG1X3T125
Style no. 66A3613G17
Quantity - 3

Instructions for assembling collar
to circuit breaker

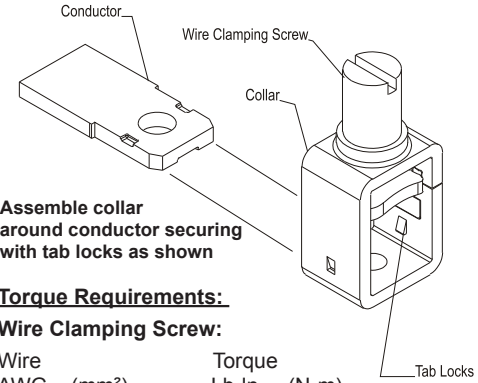

Assemble collar
around conductor securing
with tab locks as shown

Torque Requirements:

Wire Clamping Screw:

Wire AWG (mm ²)	Torque Lb-In (N-m)
14-10 (2.5-6)	35 (4.0)
8 (10)	40 (4.5)
6-4 (16-25)	45 (5.1)
3-3/0 (35-95)	50 (5.6)

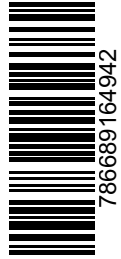

Powering Business Worldwide

Power Defense™

Circuit Breaker Accessory

For PDG1 Frame

IL012165EN H03

PDG1 Box Terminal (Steel) 125 amps,
AWG 14-3/0, 3 poles
Cat. no. PDG1X3T125
Style no. 66A3613G17
Quantity - 3

Instructions for assembling collar
to circuit breaker

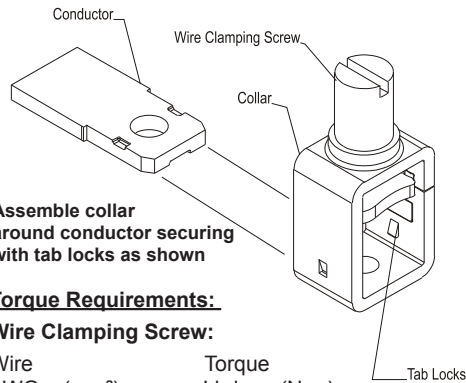

Assemble collar
around conductor securing
with tab locks as shown

Torque Requirements:

Wire Clamping Screw:

Wire AWG (mm ²)	Torque Lb-In (N-m)
14-10 (2.5-6)	35 (4.0)
8 (10)	40 (4.5)
6-4 (16-25)	45 (5.1)
3-3/0 (35-95)	50 (5.6)

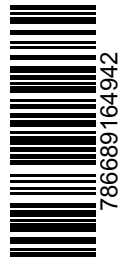

Powering Business Worldwide

Power Defense™

Circuit Breaker Accessory

For PDG1 Frame

IL012165EN H03

PDG1 Box Terminal (Steel) 125 amps,
AWG 14-3/0, 3 poles
Cat. no. PDG1X3T125
Style no. 66A3613G17
Quantity - 3

Instructions for assembling collar
to circuit breaker

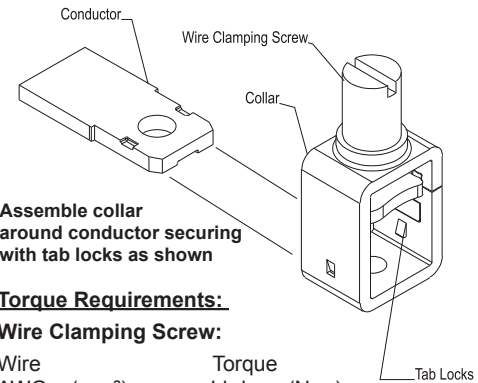

Assemble collar
around conductor securing
with tab locks as shown

Torque Requirements:

Wire Clamping Screw:

Wire AWG (mm ²)	Torque Lb-In (N-m)
14-10 (2.5-6)	35 (4.0)
8 (10)	40 (4.5)
6-4 (16-25)	45 (5.1)
3-3/0 (35-95)	50 (5.6)

