

Power Over Ethernet (PoE)/PD

Configurable forward transformer

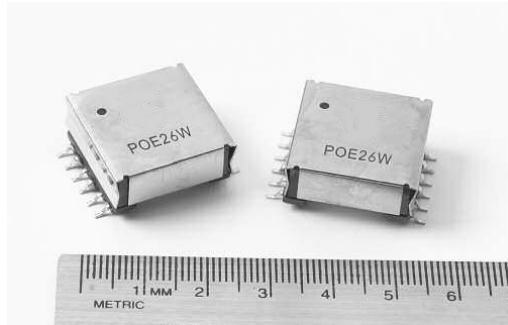

Product features

- Versatile design allows multiple output variations
- Forward topology, 300 kHz switching frequency
- Input range from 29.5 V - 60.0 V
- 1500 Vac isolation between primary and secondary
- Power 26 watts
- Low leakage inductance

Applications

- For IEEE 802.3af-compliant Power over Ethernet applications
- UPS, VoIP phone, Wireless LAN access point, Bluetooth access point, Network camera, Building access systems
- Retail Point-of-information systems
- Vending and gaming machines

Environmental data

- Storage temperature range (component): -40 °C to +125 °C
- Operating temperature range: -40 °C to +125 °C (ambient plus self-temperature rise)
- Solder reflow temperature: J-STD-020 (latest revision) compliant



Product specifications

Part Number	Watts	Primary Induct. (uH)	Output	Bias	Sync	DCR/ Pri (ohms) max	DCR/ Sec (ohms) max	DCR/ Bias (ohms) max	DCR/ Sync (ohms) max	Leakage Induct. (uh) typ.	Pri Current Pk (Adc)	Turns ratio pins Pri (2 - 4): V1 (12 - 10): V2 (11 - 9): Bias (1 - 6): Sync (7 - 8)
PoE26W3.3VS5-R	26	160	(2)x3.3V@4.0A	10.0V@0.1A	5V@0.1A	0.100	0.025	0.90	0.42	1.0	2.6	1:0.29:0.29:0.83:0.42 +/-2%
PoE26W3.3VS10-R	26	160	(2)x3.3V@4.0A	10.0V@0.1A	10V@0.1A	0.100	0.025	0.90	0.90	1.0	2.6	1:0.29:0.29:0.83:0.83 +/-2%
PoE26W5V-R	26	160	(2)x5.0V@2.6A	10.0V@0.1A	5.0V@0.1A	0.100	0.050	0.90	0.42	1.0	2.6	1:0.42:0.42:0.83:0.42 +/-2%

(1) Test parameters: 100 kHz, 0.100 Vrms, 0.0 Adc
(2) DCR limits maximum @ +20 °C

(3) Leakage Inductance 300 kHz, 0.01 Vrms, 0.0 Adc

Dimensions- mm

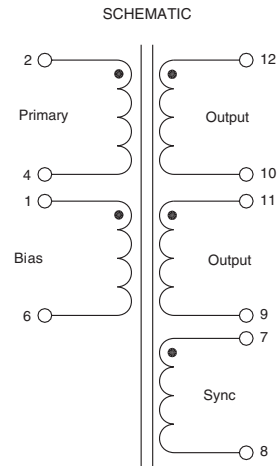
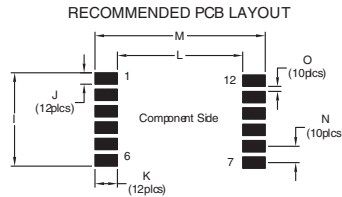
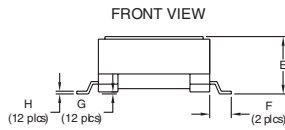
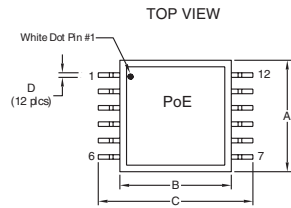

DIMENSIONS

	A mm max.	B mm ref.	C mm max.	D mm ref.	E mm max.	F mm ref.	G mm ref.	H mm ref.	I mm ref.	J mm	K mm	L mm ref.	M mm max.	N mm	O mm
	21.5	22.0	28.5	0.7	10.8	2.95	0.1	0.4	17.25	2.25	3.15	23.2	29.5	3.0	0.75

- 1) Tolerances A - H are ± 0.25 mm unless specified otherwise.
- 2) Tolerances I - O are ± 0.10 mm unless specified otherwise
- 3) All soldering surfaces are coplanar to within ± 0.102 mm.
- 4) Do not rout traces or vias underneath the transformer

Packaging information- mm

Parts packaged on 13" Diameter reel, 115 parts per reel.

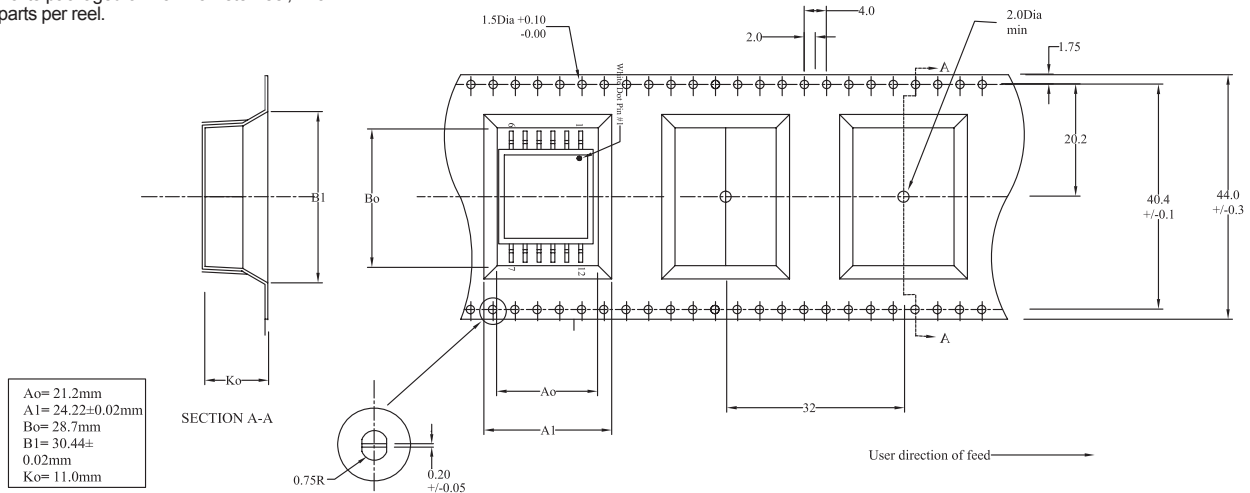

A0= 21.2mm
A1= 24.22±0.02mm
B0= 28.7mm
B1= 30.44±0.02mm
K0= 11.0mm

Solder Reflow Profile

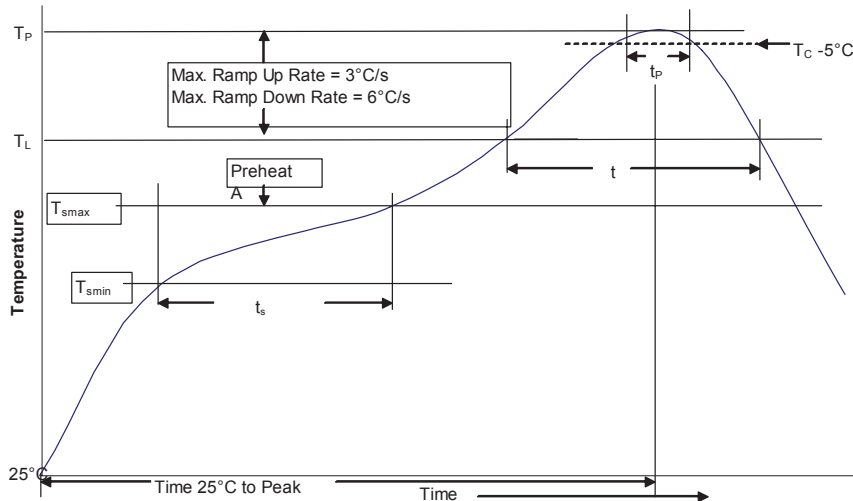

Table 1 - Standard SnPb Solder (T_C)

Package Thickness	Volume mm^3 <350	Volume mm^3 ≥ 350
<2.5mm	235°C	220°C
$\geq 2.5\text{mm}$	220°C	220°C

Table 2 - Lead (Pb) Free Solder (T_C)

Package Thickness	Volume mm^3 <350	Volume mm^3 350 - 2000	Volume mm^3 >2000
<1.6mm	260°C	260°C	260°C
1.6 – 2.5mm	260°C	250°C	245°C
>2.5mm	250°C	245°C	245°C

Reference JDEC J-STD-020

Profile Feature	Standard SnPb Solder	Lead (Pb) Free Solder
Preheat and Soak	• Temperature min. (T_{smin})	100°C
	• Temperature max. (T_{smax})	150°C
	• Time (T_{smin} to T_{smax}) (t_s)	60-120 Seconds
Average ramp up rate T_{smax} to T_P	3°C/ Second Max.	3°C/ Second Max.
Liquidous temperature (T_L)	183°C	217°C
Time at liquidous (t_L)	60-150 Seconds	60-150 Seconds
Peak package body temperature (T_P)*	Table 1	Table 2
Time (t_p)** within 5 °C of the specified classification temperature (T_C)	20 Seconds**	30 Seconds**
Average ramp-down rate (T_P to T_{smax})	6°C/ Second Max.	6°C/ Second Max.
Time 25°C to Peak Temperature	6 Minutes Max.	8 Minutes Max.

* Tolerance for peak profile temperature (T_P) is defined as a supplier minimum and a user maximum.

** Tolerance for time at peak profile temperature (t_p) is defined as a supplier minimum and a user maximum.

Life Support Policy: Eaton does not authorize the use of any of its products for use in life support devices or systems without the express written approval of an officer of the Company. Life support systems are devices which support or sustain life, and whose failure to perform, when properly used in accordance with instructions for use provided in the labeling, can be reasonably expected to result in significant injury to the user.

Eaton reserves the right, without notice, to change design or construction of any products and to discontinue or limit distribution of any products. Eaton also reserves the right to change or update, without notice, any technical information contained in this bulletin.

Eaton
Electronics Division
1000 Eaton Boulevard
Cleveland, OH 44122
United States
www.eaton.com/electronics

© 2017 Eaton
All Rights Reserved
Printed in USA
Publication No. 4081
July 2017