

# Series DU 635 DN65 PN32

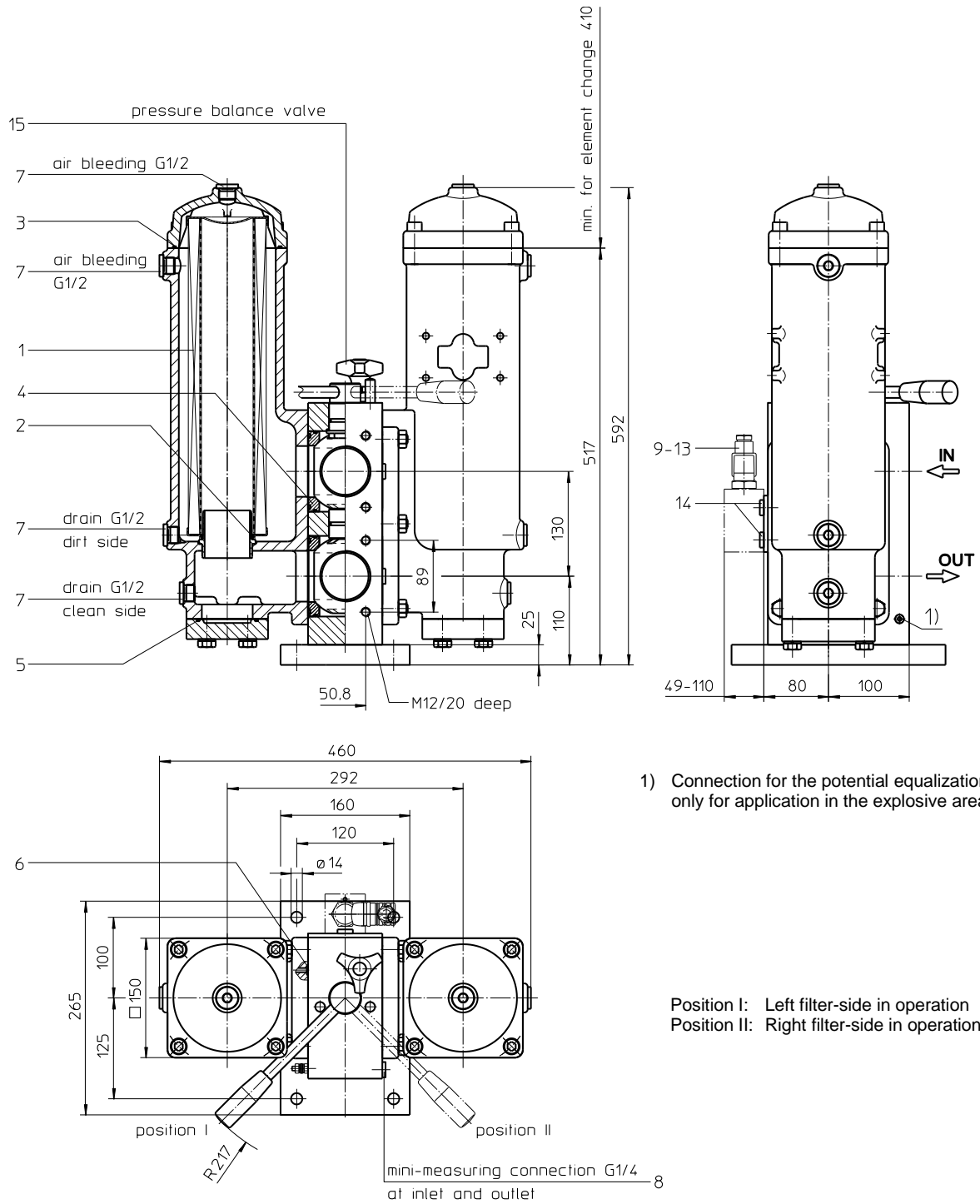

1) Connection for the potential equalization, only for application in the explosive area.

Position I: Left filter-side in operation  
Position II: Right filter-side in operation

weight: approx. 92 kg

Dimensions: mm

Designs and performance values are subject to change.

# Pressure Filter, change over Series DU 635 DN65 PN32

## Description:

Pressure filter change over series DU 635 have a working pressure up to 32 bar. Pressure peaks can be absorbed with a sufficient safety margin.

A changeover ball valve between the two filter housings makes it possible to switch from the dirty filter side to the clean filter side without interrupting operation. These filters can be installed as suction filters.

The filter element consists of star-shaped, pleated filter material, which is supported on the inside by a perforated core tube and is bonded to the end caps with a high-quality adhesive. The flow direction is from outside to inside.

For cleaning the stainless steel mesh element (see special leaflets 21070-4 and 39448-4) or changing the filter element, remove the cover and take out the element. The mesh elements are not guaranteed to maintain 100% performance after cleaning.

For filtration finer than 40 µm, use the disposable elements made of microglass. Filter elements as fine as 5 µm(c) are available; finer filter elements are available upon request.

Eaton filter elements are known for a high intrinsic stability and an excellent filtration capability, a high dirt-retaining capacity and a long service life.

Eaton filter can be used for petroleum-based fluids, HW emulsions, water glycols, most synthetic fluids and lubrication fluids. Consult factory for specific fluid applications.

Ship classifications available upon request.

## Type index:

**Complete filter:** (ordering example)

**DU. 635. 10VG. 30. E. P. -. FS. 9. -. -. -. AE**

1	2	3	4	5	6	7	8	9	10	11	12	13
---	---	---	---	---	---	---	---	---	----	----	----	----

**1 series:**

DU = pressure filter, change over

**2 nominal size:** 635

**3 filter-material:**

80G, 40G, 25G stainless steel wire mesh  
25VG, 16VG, 10VG, 6VG, 3VG microglass  
25API, 10API microglass according to API  
10P paper

**4 filter element collapse rating:**

30 = Δp 30 bar

**5 filter element design:**

E = single end open  
S = with bypass valve Δp 2,0 bar  
S1 = with bypass valve Δp 3,5 bar

**6 sealing material:**

P = Nitrile (NBR)  
V = Viton (FPM)

**7 filter element specification:**

- = standard  
VA = stainless steel  
IS06 = for HFC application, see sheet-no. 31601  
IS07 = for oil/amonia mixtures (NH<sub>3</sub>), see sheet-no. 31602

**8 process connection:**

FS = SAE-flange connection 3000 PSI

**9 process connection size:**

9 = 2 1/2"

**10 filter housing specification:**

- = standard  
IS12 = internal parts of change over armature stainless steel, see sheet-no. 41028

**11 pressure vessel specification:**

- = standard (PED 2014/68/EU)  
IS20 = ASME VIII Div.1 with ASME equivalent material, see sheet-no. 55217 (max. operating pressure 16 bar)  
IS14 = pressure vessel parts are calculated acc. to EN 13445 see sheet-no. 69828 (max. operating pressure 10 bar)

**12 internal valve:**

- = without

**13 clogging indicator or clogging sensor:**

- = without  
AOR = visual, see sheet-no.1606  
AOC = visual, see sheet-no.1606  
AE = visual-electric, see sheet-no.1609  
OP = visual, see sheet-no.1628  
OE = visual-electric, see sheet-no.1628  
VS5 = electronic, see sheet-no.1641

To add an indicator/sensor to your filter, use the corresponding indicator data sheet to find the indicator details and add them to the filter assembly model code.

**Filter element:** (ordering example)

**01NL. 630. 10VG. 30. E. P. -**

1	2	3	4	5	6	7
---	---	---	---	---	---	---

**1 series:**

01NL. = standard filter element according to DIN 24550, T3

**2 nominal size:** 630

**3 - 7** see type index complete filter

## Accessories:

- gauge port and bleeder connection, see sheet-no. 1650
- drain- and bleeder connection, see sheet-no. 1651
- SAE-counter flanges, see sheet-no. 1652
- shut-off valve, see sheet-no. 1655

## Technical data:

operating temperature:	-10°C to +100°C
operating medium:	mineral oil, other media on request
max. operating pressure:	32 bar
test pressure:	64 bar
max. operating pressure with IS20:	16 bar
test pressure with IS20:	32 bar
max. operating pressure with IS14:	10 bar
test pressure with IS14:	20 bar
process connection:	SAE-flange connection 3000 PSI
housing material:	EN-GJS-400-18-LT
switching housing material:	S355J2+N
sealing material:	Nitrile (NBR) or Viton (FPM), other materials on request
installation position:	vertical
measuring connections:	G ¼
drain- and bleeder connections:	G ½
volume tank:	2x 5,7 l

Classified under the Pressure Equipment Directive 2014/68/EU for mineral oil (fluid group 2), Article 4, Para. 3.  
 Classified under ATEX Directive 2014/34/EU according to specific application (see questionnaire sheet-no. 34279-4).

## Pressure drop flow curves:

### Filter calculation/sizing

The pressure drop of the assembly at a given flow rate Q is the sum of the housing  $\Delta p$  and the element  $\Delta p$  and is calculated as follows:

$$\Delta p_{assembly} = \Delta p_{housing} + \Delta p_{element}$$

$$\Delta p_{housing} = (\text{see } \Delta p = f(Q) \text{ - characteristics})$$

$$\Delta p_{Element} (mbar) = Q \left( \frac{l}{min} \right) \times \frac{MSK (mbar)}{10 \left( \frac{l}{min} \right)} \times v \left( \frac{mm^2}{s} \right) \times \frac{p}{0,876} \left( \frac{kg}{dm^3} \right)$$

For ease of calculation our Filter Selection tool is available online at

[www.eatonpowersource.com/calculators/filtration/](http://www.eatonpowersource.com/calculators/filtration/)

### Material gradient coefficients (MSK) for filter elements

The material gradient coefficients in mbar/(l/min) apply to mineral oil (HLP) with a density of 0,876 kg/dm<sup>3</sup> and a kinematic viscosity of 30 mm<sup>2</sup>/s (139 SUS). The pressure drop changes proportionally to the change in kinematic viscosity and density.

DU	VG					G			P	API	
	3VG	6VG	10VG	16VG	25VG	25G	40G	80G	10P	10API	25API
635	0,436	0,303	0,194	0,169	0,115	0,0142	0,0132	0,0091	0,092	0,099	0,045

### $\Delta p = f(Q)$ – characteristics according to ISO 3968

The pressure drop characteristics apply to mineral oil (HLP) with a density of 0,876 kg/dm<sup>3</sup>. The pressure drop changes proportionally to the density.

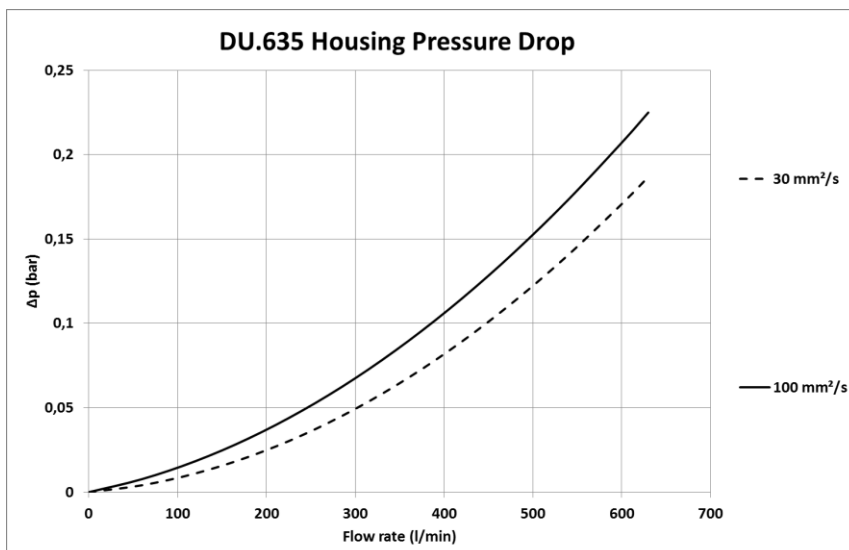

## Symbols:

without indicator

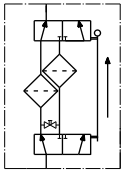

with electric indicator  
AE 30 and AE 40

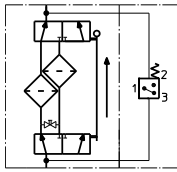

with visual-electric indicator  
AE 50 and AE 62

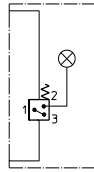

with visual-electric indicator  
AE 70 and AE 80

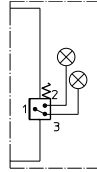

with visual indicator  
AOR/AOC/OP

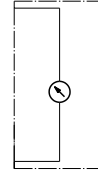

with visual-electric indicator  
OE

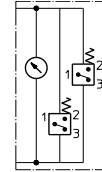

with electronic sensor  
VS5

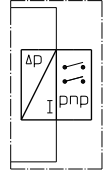

## Spare parts:

item	qty.	designation	dimension	article-no.	
1	2	filter element	01NL.630...		
2	2	O-ring	60 x 3,5	304377 (NBR)	304398 (FPM)
3	2	O-ring	125 x 3	306025 (NBR)	307358 (FPM)
4	4	gasket kit of change over UKK	2 1/2" (DN65)	322718 (NBR)	322719 (FPM)
5	2	O-ring	69,45 x 3,53	305868 (NBR)	307357 (FPM)
6	4	O-ring	8 x 2	310004 (NBR)	316530 (FPM)
7	8	screw plug	G 1/2	304678	
8	2	screw plug	G 1/4	305003	
9	1	clogging indicator, visual	AOR or AOC	see sheet-no. 1606	
10	1	clogging indicator, visual r, optisch	OP	see sheet-no. 1628	
11	1	clogging indicator, visual-electric	OE	see sheet-no. 1628	
12	1	clogging indicator, visual-electric	AE	see sheet-no. 1609	
13	1	clogging sensor, electronic	VS5	see sheet-no. 1641	
14	2	screw plug	G 1/4	305003	
15	1	pressure balance valve	DN10	305000	

item 14 execution only without clogging indicator or clogging sensor

## Test methods:

Filter elements are tested according to the following ISO standards:

ISO 2941	Verification of collapse/burst resistance
ISO 2942	Verification of fabrication integrity
ISO 2943	Verification of material compatibility with fluids
ISO 3723	Method for end load test
ISO 3724	Verification of flow fatigue characteristics
ISO 3968	Evaluation of pressure drop versus flow characteristics
ISO 16889	Multi-pass method for evaluating filtration performance

### North America

44 Apple Street  
Tinton Falls, NJ 07724  
Toll Free: 800 656-3344  
(North America only)  
Tel: +1 732 212-4700

### China

No. 3, Lane 280,  
Linhong Road  
Changning District, 200335  
Shanghai, P.R. China  
Tel: +86 21 5200-0099

### Europe/Africa/Middle East

Auf der Heide 2  
53947 Nettersheim, Germany  
Tel: +49 2486 809-0

Friedensstraße 41  
68804 Altlußheim, Germany  
Tel: +49 6205 2094-0

An den Nahewiesen 24  
55450 Langenlonsheim, Germany  
Tel: +49 6704 204-0

### Singapore

100G Pasir Panjang Road #07-08  
Singapore 118523  
Tel: +65 6825-1668

### Brazil

Av. Ermano Marchetti, 1435 -  
Água Branca, São Paulo - SP,  
05038-001, Brazil  
Tel: +55 11 3616-8461

For more information, please

email us at [filtration@eaton.com](mailto:filtration@eaton.com)

or visit [www.eaton.com/filtration](http://www.eaton.com/filtration)

© 2020 Eaton. All rights reserved. All trademarks and registered trademarks are the property of their respective owners. All information and recommendations appearing in this brochure concerning the use of products described herein are based on tests believed to be reliable. However, it is the user's responsibility to determine the suitability for his own use of such products. Since the actual use by others is beyond our control, no guarantee, expressed or implied, is made by Eaton as to the effects of such use or the results to be obtained. Eaton assumes no liability arising out of the use by others of such products. Nor is the information herein to be construed as absolutely complete, since additional information may be necessary or desirable when particular or exceptional conditions or circumstances exist or because of applicable laws or government regulations.