

LOGICDATA

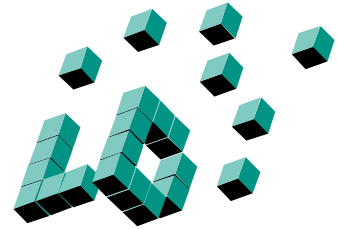

LOGICDATA Electronic & Software Entwicklungs GmbH
Hinterleitenstrasse 22a
A-8523 Frauental / Austria

Motor-Control for Height-Adjustable Desks

Before starting the system, please carefully read this manual and keep it safely for future reference.

CBS-2-xxx-xPx
CBB-3-xxx-xPx
CBB-4-xxx-xPx
HSU-OD-4
HSU-xxx-4M4

Contents

CONTENTS	22
SAFETY	23
CHARACTERISTICS AND FUNCTION	24
INSTALLATION UND STARTING UP	25
OPERATION	27
Handset	27
Drive 1 Up / Down	28
Drive 2 Up / Down	28
Saving of a Position	29
Moving to a Saved Position	30
Power fail	30
SETTINGS	31
Setting of indicated Height	31
Alignment of Limit of Travel	32
EXTENDED SETTING	33
Calibration	33
Without adjustment of the indicated height	33
Including adjustment of the indicated height	35
If you have a handset without a display	37
Setting of Number of Drives for Synchronous Operation	37
APPENDIX	39
Water Protection, Cleaning	39
Technical Data	39
Trouble-Shooting	40

Safety



**The safety instructions are to be observed under all circumstances!
If the system is inappropriately operated, it might cause danger for
persons and objects!**

- Any opening and exchange of electronic equipment may be carried out by appropriately trained personnel only.
- In case of malfunction, like e.g. development of smoke or gas, or unusual noises, all system components are to be turned off and all connecting cables and mains cables are to be disconnected.
- The operating time as written on the type plate may not be exceeded.
- Electric supply lines may not be exposed to danger of pinching, to bending or tensile stress.
- Modification of the control and of the operating element are not admissible.
- Components may not be operated in an explosive atmosphere!
- When operating the drive it must be watched that no objects (e.g. furniture) get caught!
- Fastening plates made of metal are to be grounded, res. insulated by the customer.
- Before plugging and unplugging the motor and handset cables, the mains cable has to be disconnected.
- Regarding to EMI standards the length of the motor cables must not exceed 2 meters.

Characteristics and Function

These synchronous control systems serve for the control of height-adjustable desk systems.

Depending on the type, up to 4 drives can be controlled, which are divided in 2 separate motor groups. The drives of each motor group are controlled synchronously.

Moving up and down are the basic functions of the desk. These two functions can be carried out with all handsets.

Additional functions are: memory function for positions and drive to these positions. For this purpose a handset with position keys is necessary however.

Installation und Starting Up

 Plug in handset and drives.

CBS-2-xxx: Type with 2 motors.

An 8-pin DIN socket is provided for each drive.

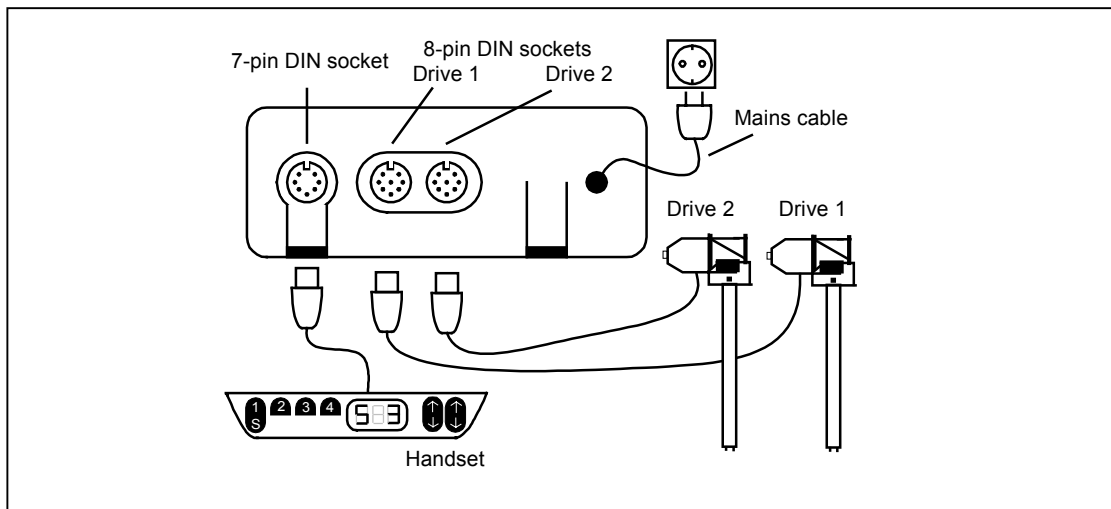

CBB-3-xxx: Type with 3 motors:

An 8-pin DIN socket is provided for each drive.

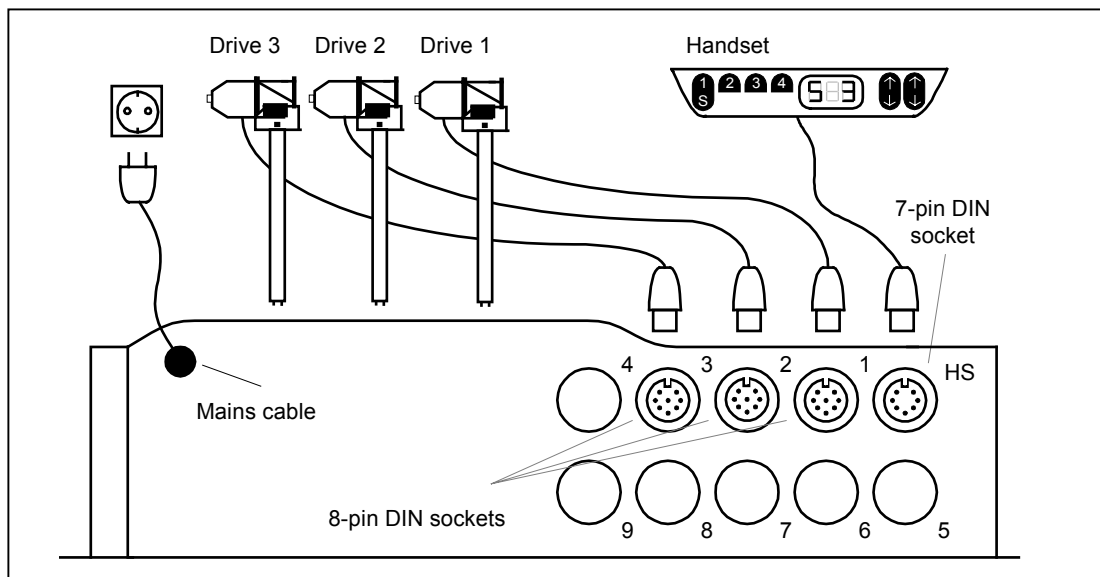

CBB-4-xxx: Type with 4 motors

An 8-pin DIN socket is provided for each drive.

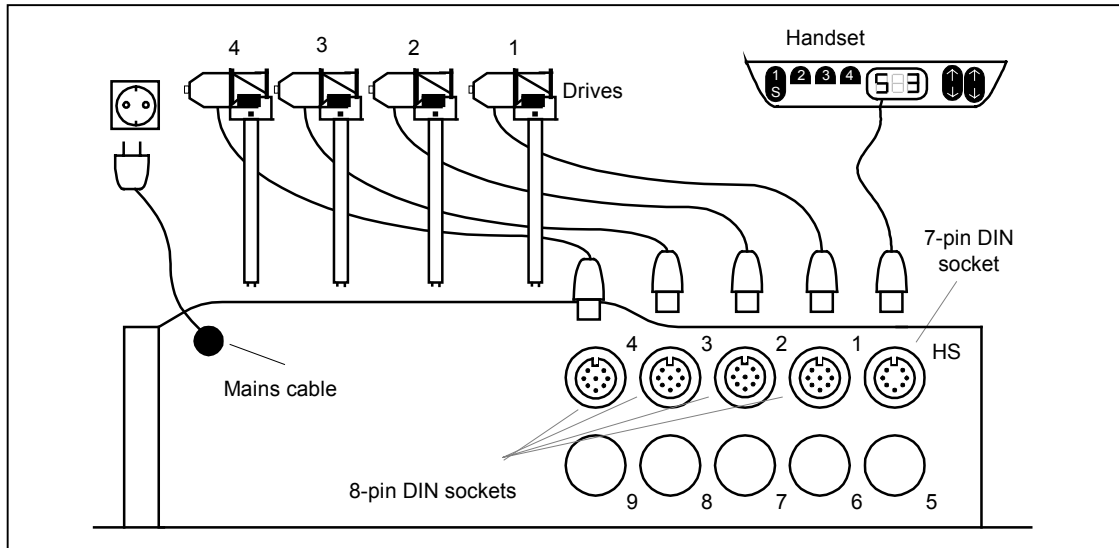

Plug in mains supply.



Attention:

Before starting the system, please make sure, that the operating voltage of the system conforms with the local power supply.

The system is operating as soon as the mains supply is plugged in.



When starting the system for the first time, a calibration sequence must be carried out by qualified personnel. This is only necessary, when the desk has no mechanical limit switches.



For the enduser, the basic functions of the desk are described particularly in the Operation menu.

Operation

Handset

HSU-OD-4:

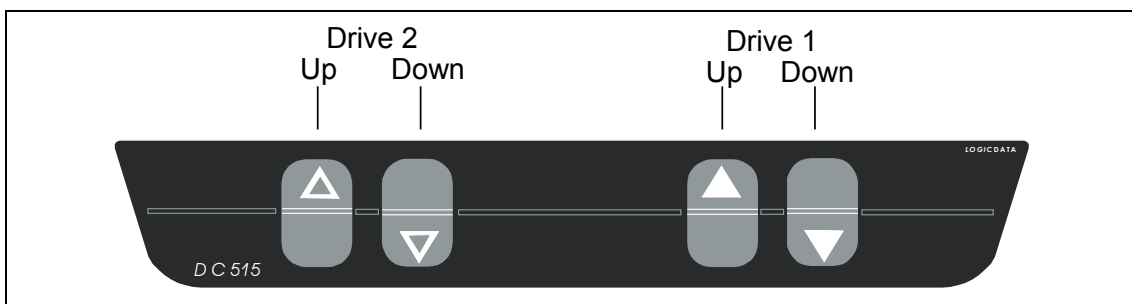

HSU-OD-4M4:

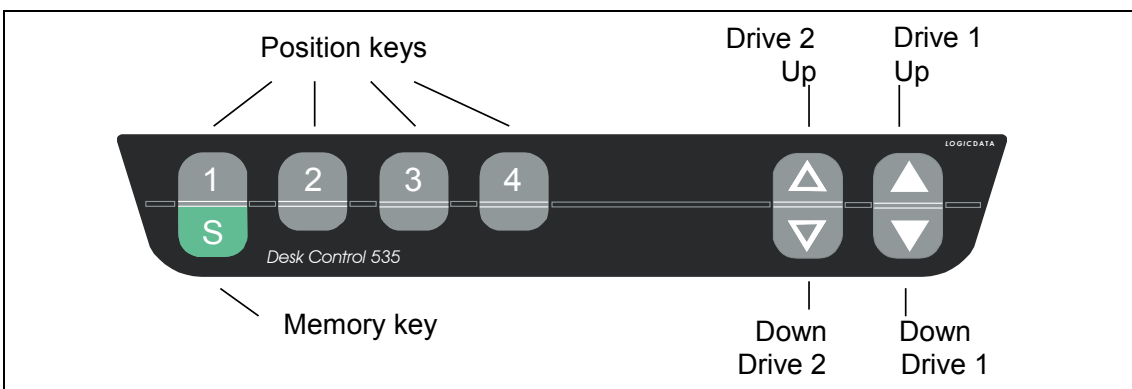

HSU-MDF-4M4:

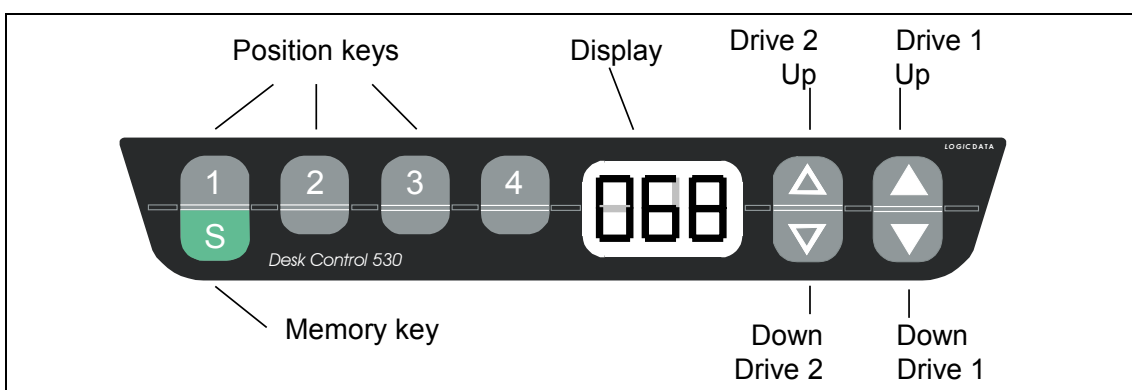

Drive 1 Up / Down

This function serves for an easy height adjustment of the first motor group.



Press  or .

The key is to be pressed until the desired height of the desk has been reached.

The display always shows the actual height.

Example:

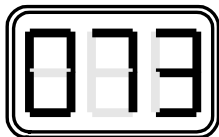

The desk moves as long as the key is pressed, or until the end position is reached.



Attention:

The desk stops, if an additional key is pressed.

Drive 2 Up / Down

This function serves for the control of the second motor group, e.g. for the inclination of the desk or for the monitor.



Press  or .

The desk moves as long as the key is pressed, or until the end position is reached.

For the following explanations:

- *The following functions only apply to handsets with position and memory keys. (HSU-OD-4M4 and HSU-MDF-4M4)*
- *All data concerning the display are applicable to the handset with display only. (HSU-MDF-4M4)*

Saving of a Position

This function allows the saving of a certain desk height. 4 different heights can be saved. These saved positions can be set later again. (See moving to a saved position)



Press  .



Attention:

If the memory key is pressed again, the actual height is indicated and nothing is saved.



Press one of the keys     .

After having pressed the position key, a “S” and the number of the position key is read on the display.

Example:



At the end of the memory procedure a double ‘Click’ is heard and after 2 seconds the actual height is read again.

Example:





Attention:

If the position key is not pressed again within 5 seconds after having pressed the memory key, the actual height is read again on the display and nothing is saved.

Moving to a Saved Position

→ *If the desk is turned on for the first time, all positions are corresponding with the lower end position.*

This function allows the desk to move to a saved height again. There are two opportunities to move to a saved height:

A

Press and hold one of the keys    .

The desk moves towards the position as long as the key is pressed. If the key is not pressed anymore, the desk stops.

The first motor group start moving, followed by the second.

B

Make a double click with one of the position keys (1-4).

(You can see in data sheet, if the double click is enabled.)

After double-clicking one of the keys, the desk automatically moves to the saved position. The first motor group start moving, followed by the second.



Attention:

If any other key is pressed while the desk is moving towards the saved position, the desk stops.

Power fail

After a disconnection of the power source, the first and the second¹ motor group have to be moved the the lower programmed end position.

¹ Depends on settings of the motor control

The display flashes and shows „000“.

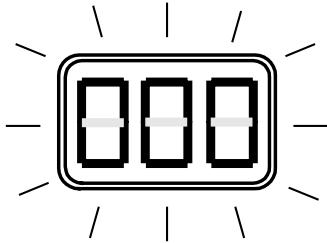

By pressing  move to the lower end position of the desk.

The desk moves down with half speed. Moving up is not possible.

After the desk has reached the lower end position, the display shows the actual height and the control box is ready for normal operation.

Settings

→ *If the sequences described below are not observed, the control returns to standard mode again and can be normally operated.*

Setting of indicated Height



With this function the indicated height can be changed.



Press  .





→ *If the next key is not pressed within 5 seconds, the control returns to standard mode again.*

 Press  now for about 5 seconds until the display starts flashing.

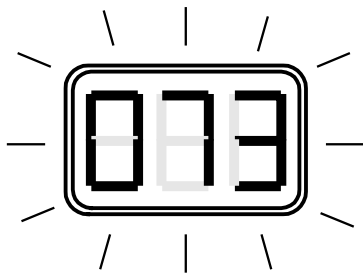
Example: (display flashes)



 Now you can set the height with  or with .

During this procedure the desk does not move.

 If the position is correctly set, the new height can be saved by pressing .

The position is saved and the display stops flashing.

The new height is also saved, if no key is pressed within 5 seconds and the display stops flashing automatically.

Alignment of Limit of Travel

If the desk gets misadjusted, or if you would like to use the set control with another desk of the same type, the lower limit of travel is to be aligned.

 Press .

Hold this key until the desk has reached the lower end position. The desk then stops automatically.

 Hold .

After about 5 seconds the desk slowly starts moving again until it has reached the absolute limit of travel. The desk stops automatically again.



Release the key.

Now the desk will not move to the limit stop again and can be operated normally again

Depending on the settings of the motor control, the second motor group has to be moved to the lower end position too.

Extended Setting



Attention:

These functions may be carried out by qualified personnel only!

If the sequences described below are not observed, the control returns to standard mode again and can be operated normally.

Calibration

The calibration sequence serves for the setting of the upper and the lower stop position, if there are no mechanical limit switches. The calibration sequence is not necessary, if the desk has mechanical limit switches.

When starting the system for the first time, this calibration sequence must be carried out, as the drive will be damaged if it always drives against the hard stop.

Depending of the settings of the motor control, 3 types of calibration modes are differed:

- Without adjustment of the indicated height (with HSU-MDF-4M4 only)
- Including adjustment of the indicated height (with HSU-MDF-4M4 only)
- If you have a handset without a display

Without adjustment of the indicated height





Press  ,  and  at the same time.

Hold this key combination for about 10 seconds, until “S 0”, “S 7”, “S 8” or “S 9” is read on the display:

Example:



Press  or , until “S 9” is shown on the display.



Press  to confirm.



By pressing  move to the lower end position of the desk.

The control automatically turns off as soon as the end position is reached.



By pressing  move to the upper end position of the desk.

The control turns off automatically as soon as the end position is reached.

Now one of the following three points can be chosen:



If you want to save a new end position, press .

The control now saves the input data and does not drive against the hard stop any more.



If you do not want to save any new end positions, but want to keep the old positions, press .

The control now finishes the calibration sequence without saving.



If you want to delete the end positions, press .

The control finishes the calibration sequence and deletes the saved end positions.

Including adjustment of the indicated height



Press ,  and  at the same time.

Hold this key combination for about 10 seconds, until “S 0”, “S 7”, “S 8” or “S 9” is read on the display:

Example:





Press  or , until “S 7” is shown on the display.



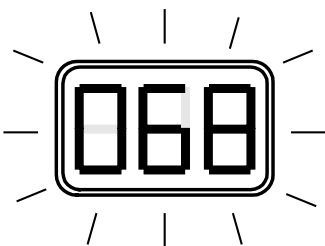

Press  to confirm.



The display starts flashing and shows “068”.



 By pressing  move to the lower end position of the desk.



The control automatically turns off as soon as the end position is reached.

 The indicated height can be incremented by pressing  and decremented by pressing .

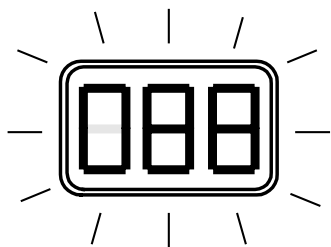

 Press  to confirm the adjusted height.



The displays continuous flashing and now shows "088".



 By pressing  move to the desired upper end position of the desk.

The control automatically turns off as soon as the end position is reached.

 The indicated height can be incremented by pressing  and decremented by pressing .

 Press  to confirm the adjusted height.

The displays stops flashing and shows the adjusted height.

Example:



If you have a handset without a display

(You can see in data sheet, if this calibration mode is enabled.)

 Press  .



Hold this key until the desk has reached the lower end position. The desk then stops automatically.

 Hold  .

After about 5 seconds the desk slowly starts moving again until it has reached the absolute limit of travel. The desk stops automatically again.

 Release the key.

Now the desk will not move to the limit stop again and can be operated normally again.

In the same way you can calibrate the upper end position. Instead of the key  you have to press  .

Setting of Number of Drives for Synchronous Operation

With this function, the number of synchronously operating drives can be set. The second motor group will be deleted!

 Press  ,  and  at the same time.

Hold this key combination for about 10 seconds, until “S 0”, “S 7”, “S 8” or “S 9” is read on the display:



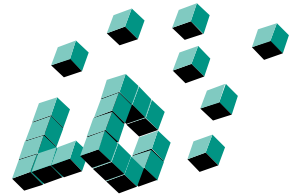

Example:





 Press  or , until "S 8" is shown on the display.



 By pressing , ,  or , the number of synchronously operating drives can be set.



Attention:

Do never set less drives on your handset than actually existing. The desk system could be destroyed then!

Appendix

Water Protection, Cleaning

- The control and the handset may only be cleaned with a dry or with a slightly wetted cloth.
Danger for persons!
- There may no liquid get into the plug-in connection.
Danger for persons!

Technical Data

See data sheet.

Trouble-Shooting

Error	Reason	Corrective Measure
Drives do not work	Control not plugged in	Plugging in mains cable
	Drive not plugged in	Plugging in motor cable
	Insufficient plug contact	Plugging in mains cable, or cables of handset or of motor correctly
	Defective drive	Ask customer service
	Defective control	Ask customer service
	Defective handset	Replace handset
Drive moves in one direction only	Defective control	Ask customer service
	Defective handset	Replace handset
Control or handset do not work	Control not plugged in	Plugging in mains cable
	Handset not plugged in	Plugging in handset
	Defective control	Ask customer service
	Defective mains cable	Ask customer service
	Defective handset	Replace handset
	Insufficient plug contact	Plugging in plug correctly