

SAVE THESE INSTRUCTIONS FOR FUTURE REFERENCE

APPLICATION

Luminaire construction is designed for use indoors and outdoors in marine and wet locations, where moisture, dirt, corrosion, vibration, and rough usage may be present.

- Wet location, Type 4X
- UL1598 Luminaires, UL1598A Marine
- IP66
- cUL

PVM supplied with a choice of voltages:

100-277VAC 50/60 Hz

108-250VDC

347V

480V

WARNING

To avoid the risk of fire, explosion, or electric shock, this product should be installed, inspected, and maintained by a qualified electrician only, in accordance with all applicable electrical codes.

WARNING

To avoid electric shock:

Be certain electrical power is OFF before and during installation and maintenance.

Luminaire must be supplied by a wiring system with an equipment grounding conductor.

To avoid burning hands:

Make sure lens and housing are cool when performing maintenance.

WARNING

To avoid explosion:

Make sure the supply voltage is the same as the luminaire voltage.

Do not install where the marked operating temperatures exceed the ignition temperature of the hazardous atmosphere.

Do not operate in ambient temperatures above those indicated on the luminaire nameplate.

Use proper supply wiring as specified on the luminaire nameplate.

All gasket seals must be clean.

Before opening, electrical power to the luminaire must be turned off. Keep tightly closed when in operation.

INSTALLATION

Mounting

1. Mount the cover module in its support position.
 - Ceiling and wall mount: mark and drill desired location on mounting surface. Secure with 1/4" (6mm) bolts or lag screws (not provided).
 - Pendant, stanchion mount: securely thread onto the appropriate NPT size conduit. Tighten set-screw located in the conduit hub. See Figure 1.
 - Cooper Crouse-Hinds HTL thread lubricant must be added to the conduit threads to prevent water from entering the fixture.

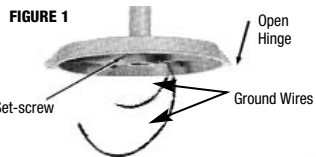

Wiring

1. Pull field wiring into cover module.
2. Close all unused conduit entries with conduit plugs provided. To prevent galling, lubricate conduit plugs with Cooper Crouse-Hinds HTL lubricant before installing. Tighten plugs securely with at least five full threads engaged.
3. Hang LED luminaire on the cover module hinge hook. See Figure 2a.
4. Connect supply wires to luminaire wire leads per the attached wiring diagrams using methods that comply with all applicable codes. See Figure 2b. Tighten all electrical connections.
5. Close driver housing onto cover module, making sure that all wires are safely inside driver. Tighten captive closing screw to 30 in.-lbs. (3.4 N-m).
6. Turn power on.



FIGURE 2a

DIAGRAM #1:
WIRING DIAGRAM FOR:
 5L, 7L & 9L

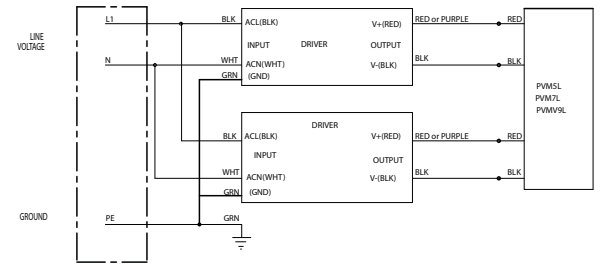

DIAGRAM #2:
WIRING DIAGRAM FOR:
 PVM3L SERIES

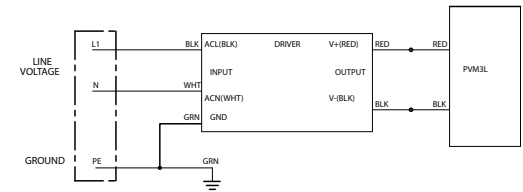

DIAGRAM #3:
WIRING DIAGRAM FOR:
 347 OR 480 VOLT TRANSFORMER

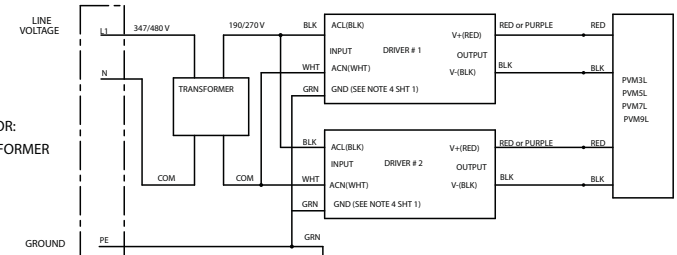
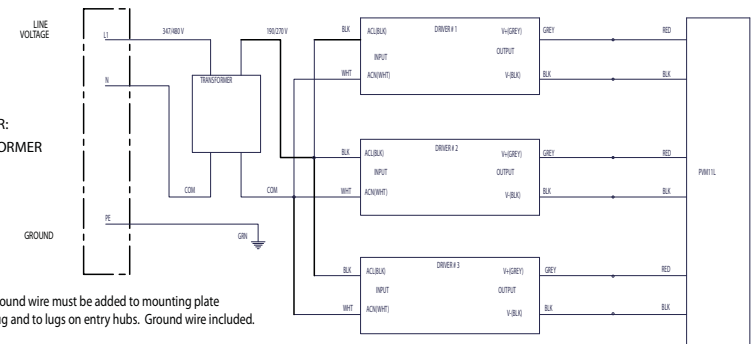

DIAGRAM #4:
WIRING DIAGRAM FOR:
 347 OR 480 VOLT TRANSFORMER
 ON PVM11L



NOTE: Ground wire must be added to mounting plate ground lug and to lugs on entry hubs. Ground wire included.

○ DENOTES CONNECTION CLOSED END CRAMP CONNECTOR PER BOM
 — DENOTES WIRE CROSS OVER, NOT CONNECTION POINT

FIGURE 2b

FIELD ASSEMBLED FIXTURES

PVM Series Lighting Fixtures, 50-140 Watt

Complete lighting fixture consists of cover, LED luminaire

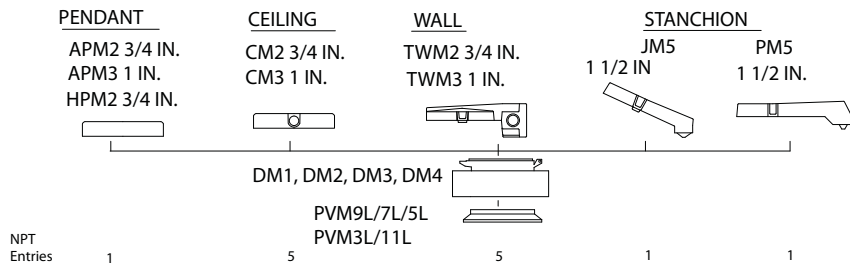

MAINTENANCE

1. Perform visual, electrical, and mechanical inspections on a regular basis. The environment and frequency of use should determine this. However, it is recommended that checks be made at least once a year. We recommend an Electrical Preventive Maintenance Program as described in the National Fire Protection Association Bulletin NFPA No. 70B: Recommended Practice For Electrical Equipment Maintenance (www.nfpa.org).
2. The lens should be cleaned periodically to ensure continued lighting performance. To clean, wipe the lens with a clean, damp cloth. If this is not sufficient, use a mild soap or a liquid cleaner such as Collinite NCF or Duco #7. Do not use an abrasive, strong alkaline, or acid cleaner. Damage may result.
3. Visually check for undue heating evidenced by discoloration of wires or other components, damaged parts, or leakage evidenced by water or corrosion in the interior. Replace all worn, damaged, or malfunctioning components, and clean gasket seals before putting the luminaire back into service.
4. Electrically check to make sure that all connections are clean and tight.
5. Mechanically check that all parts are properly assembled.

REPLACEMENT PARTS

Cooper Crouse-Hinds PVM Series luminaires are designed to provide years of reliable lighting performance. However, should the need for replacement parts arise, they are available through your authorized Cooper Crouse-Hinds distributor. Assistance may also be obtained through your local Cooper Crouse-Hinds representative.

Cooper Crouse-Hinds Sales Service Department, P.O. Box 4999, Syracuse, New York 13221, Phone (315) 477-7000.

LED MODULE REPLACEMENT INSTRUCTIONS

1. Turn off electrical power to the luminaire before opening.
2. Loosen captive closing screw, open luminaire, and leave hanging on cover module hinge hook.
3. Disconnect supply wire from luminaire wire leads and remove luminaire from cover module.
4. At workbench, remove wire nut connections from both LED drivers' DC outputs to LED module (see Step 1).
5. Unthread the three housing bolts using a 3/16" hex tool; do not remove bolts from assembly.
6. Carefully separate the heat sink/driver housing from the LED module, pulling the LED wires through the bushing in the driver housing.
7. Remove any gasket material from the bottom of the heat sink with a shop rag (see Step 2).
8. Place new LED module on workbench and inspect gasket to ensure proper sealing during assembly (see Step 3).
9. Gently place heat sink/driver housing into LED module while feeding the paired wires from the LED module through the bushing in the driver housing, being sure to align the bolts with the tapped holes in the LED module.
10. Thread the three (3) housing bolts into the LED module using a 3/16" hex tool. Torque bolts to 50 in.-lbs. (5.7 N-m).
11. Use supplied wire nuts to connect LED driver DC output to LED module wires, noting correct polarity.
12. Mount and wire luminaire per Installation Instructions.

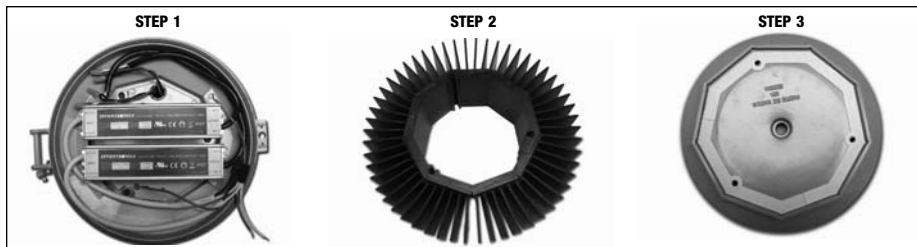

All statements, technical information and recommendations contained herein are based on information and tests we believe to be reliable. The accuracy or completeness thereof are not guaranteed. In accordance with Cooper Crouse-Hinds "Terms and Conditions of Sale," and since conditions of use are outside our control, the purchaser should determine the suitability of the product for his intended use and assumes all risk and liability whatsoever in connection therewith.