

EX - CONTROL STATIONS

**Moulded plastic
Version for Zone 1 and Zone 21**

Even under the most adverse conditions, CEAG control stations can be used and operated reliably. The enclosures consist of low-temperature impact-resistant thermoplastic which fulfils the requirements of EN 60079 and provides a high resistance to chemicals. The well thought out design with low side walls allows optimum cable connection. Quick fixing allows up to three CEAG built-in components, such as signal lamps, pushbuttons and switches, to be snapped on a rail in the enclosure. They can be snapped out of the enclosure to facilitate cable-entry feeding. Notches in the mounting rails prevent the built-in components from being twisted out of place.

Wall mounting can be carried out via easily accessible fixing apertures when the enclosure cover is sealed. CEAG mounting plates offer a time-saving fixing technique. CEAG control stations feature standard M25 moulded-plastic cable entries with an 8 to 17 mm clamping diameter. Coupling pieces link enclosures to each other and prevent them from being twisted out of place. Alternatively, metal screws and flanges can be used for mounting – the metal flanges also enable external earthing.

Free mounting areas can be provided for retrofitting certified CEAG components. These are then factory sealed with blanking elements.

Internationally approved.

- Flat side walls
- Quick fixing of all built-in components
- High chemical resistance
- Different enclosures can be combined





Type 411 83

Type 411 82

Type 411 81

Technical data

Ex-control stations Type 411 81 Type 411 82 Type 411 83		
Marking accd. to 94/9/EC	Ex II 2 G Ex ed ib m IIC T6 Ex II 2 D Ex tD A21 IP66 T80 °C	
EC-Type Examination Certificate	PTB 00 ATEX 3117	
IECEX Certificate of Conformity	IECEX BK1 04.0003	
Marking accd. to IECEx	Ex e II T6, Ex e ib IIC T6, Ex ed IIC T6 or Ex ed ib IIC T6	
Permissible ambient temperature	-20 °C up to +40 °C -55 °C up to +55 °C (option)	
Rated voltage	690 V AC	
Rated current	16 A	
Rated making-/rated breaking capacity accd. EN 60947-5-1	Ex41 AC-15: U_e 250 V / I_e 6 A U_e 500 V / I_e 4 A DC-13: U_e 24 V / I_e 6 A U_e 220 V / I_e 1 A	Ex23 AC-15: U_e 230 V / I_e 6 A U_e 500 V / I_e 4 A DC-13: U_e 24 V / I_e 2 A U_e 230 V / I_e 0.5 A
Connecting terminals	2 x 2.5 mm ²	
Protection class	I	
Degree of protection accd. to EN 60529	IP66 (standard)	
Cable glands/Gland plates/Enclosure drilling	1 x M25 Ex e cable glands for cables from Ø 8 - 17 mm or 1 x M20 thread with brass flange	
Enclosure material	Polyamide	
Enclosure colour	black	

Type 411 81

Dimensions (L x W x H)	85 x 85 x 77.5 mm
Weight (empty)	0.25 kg

Type 411 82

Dimensions (L x W x H)	125 x 85 x 77.5 mm
Weight (empty)	0.35 kg

Type 411 83

Dimensions (L x W x H)	165 x 85 x 77.5 mm
Weight (empty)	0.45 kg

Type 411 82 with measuring instrument AM 72

Movement	Moving iron	Moving coil
Marking accd. to 94/9/EC	Ex II G Ex e II	Ex II G Ex ib IIC
Accuracy	Class 2.5	Class 1.5
Overload range	10-fold -25 sec.	10-fold -5 sec.
	25-fold - 4 sec.	
	50-fold - 1 sec.	
Measuring range	n / 1A	0 - 20 mA
	0 - 25 A direct	4 - 20 mA
Inductance L_i	-	≤ 0.1 mH
Capacitance C_i	-	≤ 0.1 nF
Open circuit voltage max. U_i	-	30 V
Short circuit current max. I_i	-	150 mA
Connecting terminals	2 x 1.5 - 4 mm ²	
Weight	0.70 kg	

¹⁾ Base enclosure can be rotated after wards (entry from top or down)

Other versions available on request

Ex-control stations



Type 411 81...01



Type 411 81...12



Type 411 81...18



Type 411 81...04

4

Ordering details Type 411 81 with 1 built-in component

Content	Built-in components	Weight approx.	Order No.
	1 x pushbutton DRT 1 NO + 1 NC label: "0, I, START, STOP"	0.40 kg	GHG 411 8100 R0001
	1 x mushroom-head pushbutton SGTE 1 NO + 1 NC "Emergency stop"	0.45 kg	GHG 411 8100 R0002
	1 x mushroom-head pushbutton SGTE 1 NO + 1 NC "Emergency stop" with key unlocking	0.50 kg	GHG 411 8100 R0012
	1 x double pushbutton DDT 1 NO + 1 NC label: "0, I, START, STOP"	0.45 kg	GHG 411 8100 R0009
	1 x key-operated switch SLS 2 NO SW 5 "engaging-engaging-engaging" label: "I 0 II"	0.52 kg	GHG 411 8100 R0018
	1 x control switch SCT 1 change-over SW 6 "engaging-engaging" label: HAND – AUTO	0.45 kg	GHG 411 8100 R0003
	label: "0 – I"	0.45 kg	GHG 411 8100 R0004
	label: "I – II"	0.45 kg	GHG 411 8100 R0005
	1 x control switch SCT 2 NO SW 5 "engaging-engaging-engaging" label: HAND – 0 – AUTO	0.45 kg	GHG 411 8100 R0006
	label: "I 0 II"	0.45 kg	GHG 411 8100 R0007
	label: "Local Remote Auto"	0.45 kg	GHG 411 8100 R0008



Type 411 82...18

Type 411 82...17

Type 411 82...03

Type 411 82...01

Ordering details Type 411 82 with 2 built-in components

Content	Built-in components	Weight approx.	Order No.
	2 x pushbutton DRT 1 NO + 1 NC each label: "0, I, START, STOP"	0.54 kg	GHG 411 8200 R0001
X1 — ⊗ — X2 	1 x signal lamp SIL 20-250 V AC/DC coloured lens cover: „white, red, green, yellow“ 1 x double pushbutton DDT 1 NO + 1 NC label: "0, I, START, STOP"	0.65 kg	GHG 411 8200 R0003
	1 x double pushbutton DDT 1 NO + 1 NC label: "0, I, START, STOP"		
	1 x mushroom-head pushbutton SGT 1 NO + 1 NC "emergency stop"	0.57 kg	GHG 411 8200 R0016
	1 x control switch SCT 1 change-over SW 6 "engaging-engaging" label: "0 - I"		
	1 x mushroom-head pushbutton SGTE 1 NO + 1 NC "emergency stop"	0.57 kg	GHG 411 8200 R0017
X1 — ⊗ — X2 	1 x signal lamp SIL 20-250 V AC/DC coloured lens cover: „white, red, green, yellow“ 1 x key-operated switch 2 NO SW 5 "engaging-engaging-engaging" label: "I 0 II"	0.65 kg	GHG 411 8200 R0018

Ex-control stations



Type 411 83...01



Type 411 83...03



Type 411 83...23



Type 411 83...04

4

Ordering details Type 411 83 with 3 built-in components

Content	Built-in components	Weight approx.	Order No.
<p>X1—⊗—X2</p>	<p>1 x signal lamp SIL 20-250 V AC/DC coloured lens cover: „white, red, green, yellow“ 2 x pushbutton DRT 1 NO + 1 NC each label: “0, I, START, STOP”</p>	0.76 kg	GHG 411 8300 R0001
<p>X1—⊗—X2</p>	<p>1 x signal lamp SIL 20-250 V AC/DC coloured lens cover: „white, red, green, yellow“ 1 x double pushbutton DDT 1 NO + 1 NC label: “0, I, START, STOP” 1 x mushroom-head pushbutton SGTE 1 NO + 1 NC “emergency stop”</p>	0.80 kg	GHG 411 8300 R0003
<p>1—⊗—2</p>	<p>1 x measuring instrument AM72 CT connection n/1A Scale 0 –100%/150% 1 x control switch SCT 1 NO + 1 NC SW 8 “engaging-engaging-spring return” label: “0 - I”</p>	0.92 kg	GHG 411 8300 R0023
<p>X1—⊗—X2</p>	<p>1 x signal lamp SIL 20-250 V AC/DC coloured lens cover: „white, red, green, yellow“ 1 x double pushbutton DDT 1 NO + 1 NC label: “0, I, START, STOP” 1 x control switch SCT 1 change-over SW 6 “engaging-engaging” label: “HAND - AUTO”</p>	0.80 kg	GHG 411 8300 R0004



Measuring instrument AM72

Ordering details measuring instrument AM72, Type 411 82

Content Movement	Weight	Order No.	
Version direct measurement with 1 x entry and cable gland M25			
0 - 1 / 1.5 A	Moving iron	0.70 kg	GHG 411 8281 R0002
0 - 2.5 / 3.75 A	Moving iron	0.70 kg	GHG 411 8281 R0003
0 - 5 / 7.5 A	Moving iron	0.70 kg	GHG 411 8281 R0004
0 - 10 / 15 A	Moving iron	0.70 kg	GHG 411 8281 R0005
0 - 16 / 24 A	Moving iron	0.70 kg	GHG 411 8281 R0007
0 - 20 / 24 mA 0-100% / 120% (Ri =320 Ω)	Moving coil	0.80 kg	GHG 411 8285 R0033
4 - 20 / 24 mA 0-100% / 120% (Ri =320 Ω)	Moving coil	0.80 kg	GHG 411 8286 R0035

Version CT connection n/1A with 1 x entry and cable gland M25			
0 - 1 / 1.5 A	Moving iron	0.70 kg	GHG 411 8282 R0002
0 - 2.5 / 3.75 A	Moving iron	0.70 kg	GHG 411 8282 R0003
0 - 5 / 7.5 A	Moving iron	0.70 kg	GHG 411 8282 R0004
0 - 10 / 15 A	Moving iron	0.70 kg	GHG 411 8282 R0005
0 - 15 / 22.5 A	Moving iron	0.70 kg	GHG 411 8282 R0007
0 - 20 / 30 A	Moving iron	0.70 kg	GHG 411 8282 R0008
0 - 30 / 45 A	Moving iron	0.70 kg	GHG 411 8282 R0009
0 - 40 / 60 A	Moving iron	0.70 kg	GHG 411 8282 R0010
0 - 50 / 75 A	Moving iron	0.70 kg	GHG 411 8282 R0011
0 - 60 / 90 A	Moving iron	0.70 kg	GHG 411 8282 R0012
0 - 75 / 112.5 A	Moving iron	0.70 kg	GHG 411 8282 R0013
0 - 100 / 150 A	Moving iron	0.70 kg	GHG 411 8282 R0014
0 - 100% / 150%	Moving iron	0.70 kg	GHG 411 8282 R0001

Dimension drawing

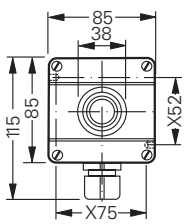

Type 411 81

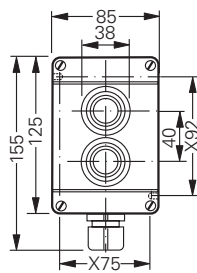

Type 411 82

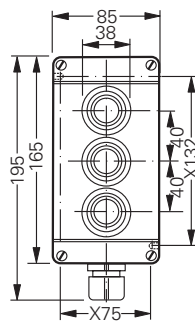

Type 411 83

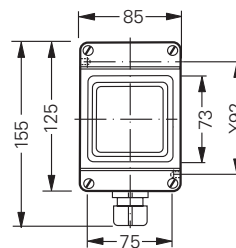

Measuring instrument AM 72

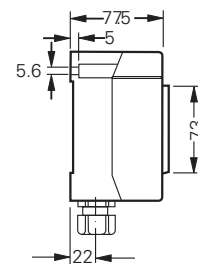

X = fixing dimension

Ex-control stations

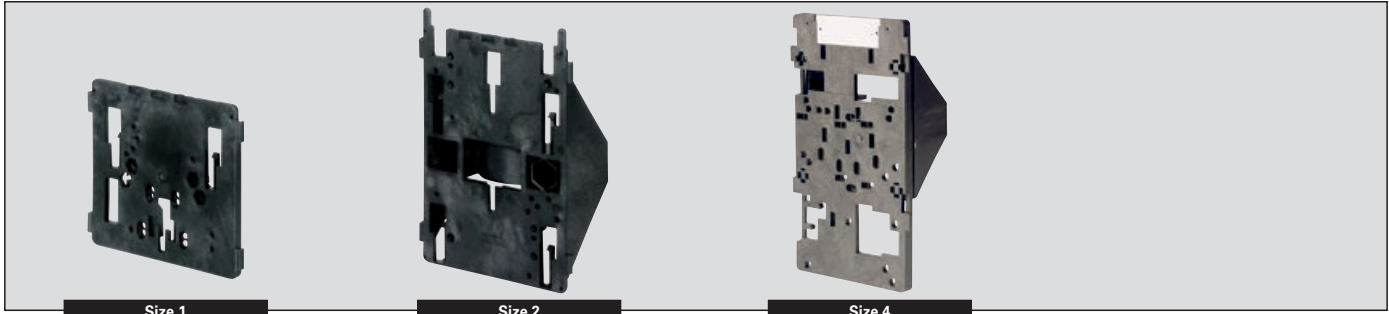

Size 1

Size 2

Size 4

4

Accessories

Mounting plate for type 411 81

Type	Application	Fixing method	OU	Order No.
Size 1	Wall mounting	screwless mounting	1	GHG 610 1953 R0101
Size 1	Pipe clamp	screwless mounting	1	GHG 610 1953 R0102
Size 1	Trellis-work mounting	screwless mounting	1	GHG 610 1953 R0103
Size 4	Wall mounting	snap-on ¹⁾	1	GHG 610 1953 R0126
Size 4	Trellis-work mounting	snap-on ¹⁾	1	GHG 610 1953 R0126
Size 4	Pipe clamp	snap-on ¹⁾	1	GHG 610 1953 R0130

Mounting plate for type 411 82 and 411 83

Type	Application	Fixing method	OU	Order No.
Size 2	Wall mounting	screwless mounting	1	GHG 610 1953 R0104
Size 2	Pipe clamp	screwless mounting	1	GHG 610 1953 R0105
Size 2	Trellis-work mounting	screwless mounting	1	GHG 610 1953 R0106
Size 4	Wall mounting	snap-on ¹⁾	1	GHG 610 1953 R0126
Size 4	Trellis-work mounting	snap-on ¹⁾	1	GHG 610 1953 R0126
Size 4	Pipe clamp	snap-on ¹⁾	1	GHG 610 1953 R0130
Plug-in fastener for CEAG modules with 5.5 mm and 11 mm mounting size per 4 pieces			10	GHG 610 1953 R0041

¹⁾ snap-on with snap-on mounting 5.5 mm

Dimension drawing

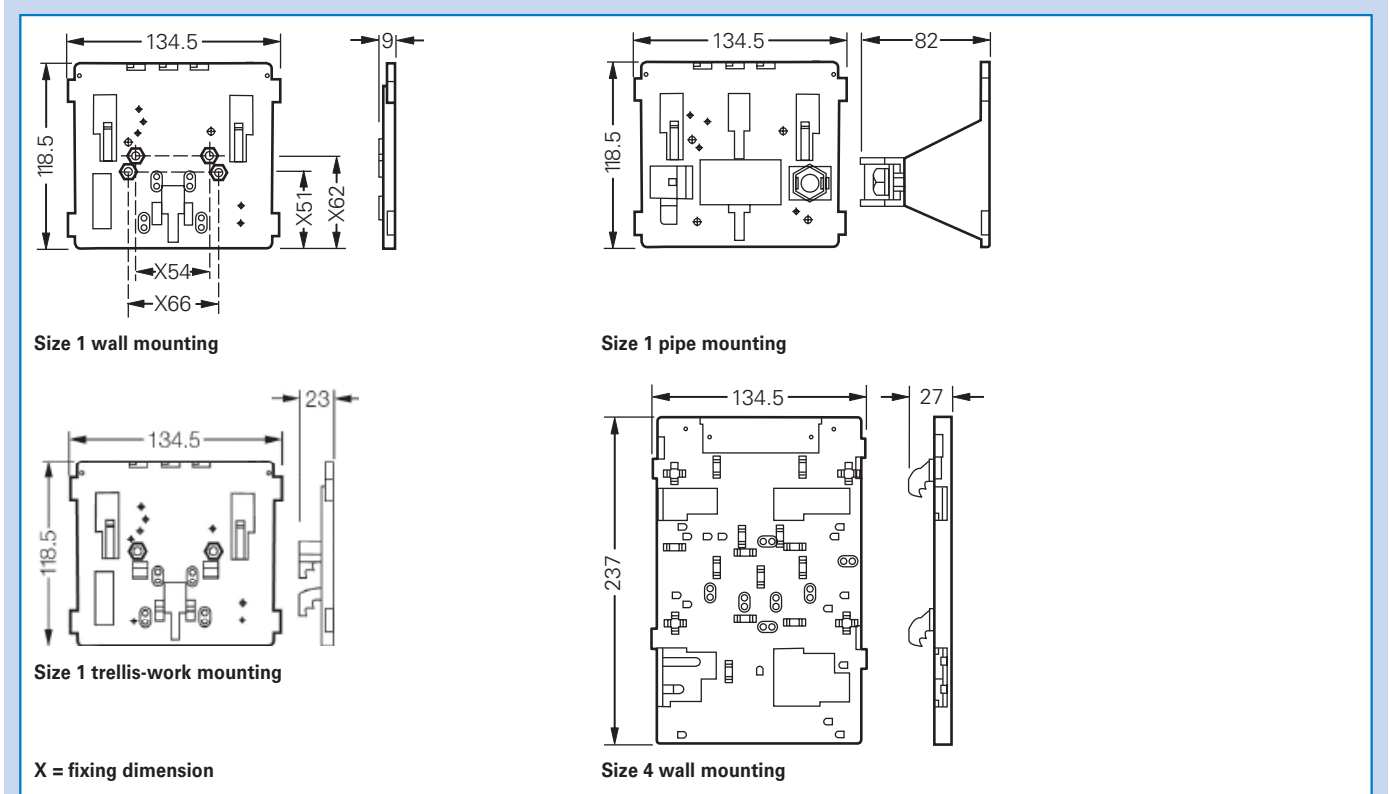

Dimensions in mm

EX - CONTROL STATION

Stainless steel
Version for Zone 1 and Zone 21

4 CEAG explosion-protected control stations made of high-grade 316L stainless steel are designed to accommodate up to four built-in components. These stainless-steel control stations with electro-polished surfaces offer protection for applications in the off-shore industry and at sites with especially severe mechanical, chemical and climatic conditions.

CEAG flameproof built-in components, such as signal lamps, pushbuttons and switches, provide snap-on mounting on rails screwed into the enclosures. To facilitate insertion of cables into the entries, the built-in components can be snapped out of the enclosures. Notches in the mounting rails define the position of the built-in components and prevent them from being twisted out of place.

Free mounting areas can be provided for retrofitting certified CEAG components. These are then factory sealed with blanking elements.

Internationally approved.



- High mechanical, chemical and thermal resistance
- Individual configuration
- Clean-room applications



Type 414 81..

Type GHG 414 82

Type GHG 414 81

Technical data

Ex-control stations Type 414 81 Type 414 82											
Marking accd. to 94/9/EC	Ⓢ II 2 G Ex ed ib m IIC T6 Ⓢ II 2 D Ex tD A21 IP66 T80 °C										
EC-Type Examination Certificate	PTB 00 ATEX 3117										
IECEX Certificate of Conformity	IECEX BK1 04.0003										
Marking accd. to IECEx	Ex e II T6, Ex e ib IIC T6, Ec ed IIC T6 or Ex ed ib IIC T6										
Permissible ambient temperature	-20 °C up to +40 °C -55 °C up to +55 °C (option)										
Rated voltage	690 V AC (with control switch GHG 23 up to 500 V)										
Rated current	16 A (with control switch GHG 23 max. 10 A)										
Rated making-/rated breaking capacity accd. EN 60947-5-1	<table border="0"> <tr> <td>Ex41</td> <td>Ex23</td> </tr> <tr> <td>AC-15: U_o 250 V / I_o 6 A</td> <td>AC-15: U_o 230 V / I_o 6 A</td> </tr> <tr> <td>U_o 500 V / I_o 4 A</td> <td>U_o 500 V / I_o 4 A</td> </tr> <tr> <td>DC-13: U_o 24 V / I_o 6 A</td> <td>DC-13: U_o 24 V / I_o 2 A</td> </tr> <tr> <td>U_o 220 V / I_o 1 A</td> <td>U_o 230 V / I_o 0.5 A</td> </tr> </table> with gold contact points max. 0.4 A	Ex41	Ex23	AC-15: U _o 250 V / I _o 6 A	AC-15: U _o 230 V / I _o 6 A	U _o 500 V / I _o 4 A	U _o 500 V / I _o 4 A	DC-13: U _o 24 V / I _o 6 A	DC-13: U _o 24 V / I _o 2 A	U _o 220 V / I _o 1 A	U _o 230 V / I _o 0.5 A
Ex41	Ex23										
AC-15: U _o 250 V / I _o 6 A	AC-15: U _o 230 V / I _o 6 A										
U _o 500 V / I _o 4 A	U _o 500 V / I _o 4 A										
DC-13: U _o 24 V / I _o 6 A	DC-13: U _o 24 V / I _o 2 A										
U _o 220 V / I _o 1 A	U _o 230 V / I _o 0.5 A										
Connecting terminals	2 x 4 mm ²										
Protection class	I										
Degree of protection accd. to EN 60529	IP66										
Cable glands/Gland plates/Enclosure drilling	1 x thread Ø 21 mm for cable gland M20										
Enclosure material	Stainless steel AISI 316 L										

Type 414 81

Dimensions (L x W x H)	166 x 140 x 76 mm
Weight (empty)	1.40 kg

Type 414 82

Dimensions (L x W x H)	286 x 140 x 76 mm
Weight (empty)	2.10 kg

Type 414 81 with measuring instrument AM 72

Movement	Moving iron	Moving coil
Marking accd. to 94/9/EC	Ⓢ II G Ex e II	Ⓢ II G Ex ib IIC
Accuracy	Class 2.5	Class 1.5
Overload range	10-fold -25 sec. 25-fold - 4 sec. 50-fold - 1 sec. indicated 1:1.5	10-fold -5 sec.
Measuring range	n / 1A 0 - 25 A direct	0 - 20 mA 4 - 20 mA
Inductance L _i	-	≤ 0.1 mH
Capacitance C _i	-	≤ 0.1 nF
Open circuit voltage max. U _i	-	30 V
Short circuit current max. I _i	-	150 mA
Connecting terminals	2 x 1.5 - 4 mm ²	
Weight	1.25 kg	

¹⁾ Base enclosure can be rotated after wards (entry from top or down)

Other versions available on request

Ex-control stations



Type 414 81...01



Type 414 81...02



Type 414 81...03



Type 414 81...04

4

Ordering details Type 414 81 with 2 built-in components

Content*	Built-in components	Weight approx.	Order No.
	2 x pushbutton DRT NO + 1 NC each label: "0, I, START, STOP"	1.80 kg	GHG 414 8100 R0001
	1 x signal lamp SIL 20-250 V AC/DC coloured lens cover: „white, red, green, yellow“ 1 x double pushbutton DDT 1 NO + 1 NC label: "0, I, START, STOP"	1.85 kg	GHG 414 8100 R0002
	1 x double pushbutton DDT 1 NO + 1 NC label: "0, I, START, STOP" 1 x mushroom-head pushbutton SGTE 1 NO + 1 NC "emergency stop"	1.85 kg	GHG 414 8100 R0003
	1 x measuring instrument AM45 CT connection n/1A Scale 0 –100%/150% 1 x double pushbutton DDT 1 NO + 1 NC label: "0, I, START, STOP"	1.85 kg	GHG 414 8100 R0004

*Without external fixing lugs (see accessories NO. 9.30)



Type 414 82...03

Type 414 82...02

Type 414 82...01

Ordering details Type 414 82 with 4 built-in components

Content*	Built-in components	Weight approx.	Order No.
<p>X1—⊗—X2</p>	<p>1 x signal lamp SIL 20-250 V AC/DC coloured lens cover: „white, red, green, yellow“ 2 x pushbutton DRT 1 NO + 1 NC label: “0, I, START, STOP” 1 x mushroom-head pushbutton SGT 1 NO + 1 NC “emergency stop”</p>	2.80 kg	GHG 414 8200 R0001
<p>X1—⊗—X2</p> <p>X1—⊗—X2</p>	<p>2 x signal lamp SIL 20-250 V AC/DC coloured lens cover: „white, red, green, yellow“ 2 x double pushbutton DDT 1 NO + 1 NC label: “0, I, START, STOP”</p>	2.80 kg	GHG 414 8200 R0002
<p>X1—⊗—X2</p>	<p>1 x signal lamp SIL 20-250 V AC/DC coloured lens cover: „white, red, green, yellow“ 1 x double pushbutton DDT 1 NO + 1 NC label: “0, I, START, STOP” 1 x mushroom-head pushbutton SGT 1 NO + 1 NC “emergency stop” 1 x key-operated switch 2 NO SW 5 “engaging-engaging-engaging” label: “I 0 II”</p>	2.90 kg	GHG 414 8200 R0003

*Without external fixing lugs (see accessories NO. 9.30)

Ex-control stations



Type 414 81..

4

Ordering details Type 414 81 with measuring instrument AM72

Content	Movement	Weight approx.	Order No.
Version direct measurement with 1 x threaded entry Ø 21 mm (without external fixing lugs)			
0 - 1 / 1.5 A	Moving iron	1.25 kg	GHG 414 8181 R0002
0 - 2.5 / 3.75 A	Moving iron	1.25 kg	GHG 414 8181 R0003
0 - 5 / 7.5 A	Moving iron	1.25 kg	GHG 414 8181 R0004
0 - 10 / 15 A	Moving iron	1.25 kg	GHG 414 8181 R0005
0 - 16 / 24 A	Moving iron	1.25 kg	GHG 414 8181 R0007
0 - 20 / 24 mA 0-100% / 120% (Ri =320 Ω)	Moving coil	1.35 kg	GHG 414 8181 R0033
4 - 20 / 24 mA 0-100% / 120% (Ri =320 Ω)	Moving coil	1.35 kg	GHG 414 8181 R0035
Version CT connection n/1A with 1 x threaded entry Ø 21 mm (without external fixing lugs)			
0 - 1 / 1.5 A	Moving iron	1.25 kg	GHG 414 8182 R0002
0 - 2.5 / 3.75 A	Moving iron	1.25 kg	GHG 414 8182 R0003
0 - 5 / 7.5 A	Moving iron	1.25 kg	GHG 414 8182 R0004
0 - 10 / 15 A	Moving iron	1.25 kg	GHG 414 8182 R0005
0 - 15 / 22.5 A	Moving iron	1.25 kg	GHG 414 8182 R0007
0 - 20 / 30 A	Moving iron	1.25 kg	GHG 414 8182 R0008
0 - 30 / 45 A	Moving iron	1.25 kg	GHG 414 8182 R0009
0 - 40 / 60 A	Moving iron	1.25 kg	GHG 414 8182 R0010
0 - 50 / 75 A	Moving iron	1.25 kg	GHG 414 8182 R0011
0 - 60 / 90 A	Moving iron	1.25 kg	GHG 414 8182 R0012
0 - 75 / 112.5 A	Moving iron	1.25 kg	GHG 414 8182 R0013
0 - 100 / 150 A	Moving iron	1.25 kg	GHG 414 8182 R0014
0 - 100% / 150%	Moving iron	1.25 kg	GHG 414 8182 R0033

Accessories

Type	Order No.
External fixing lugs (2 pcs)	GHG 610 1941 R0013

Dimension drawing

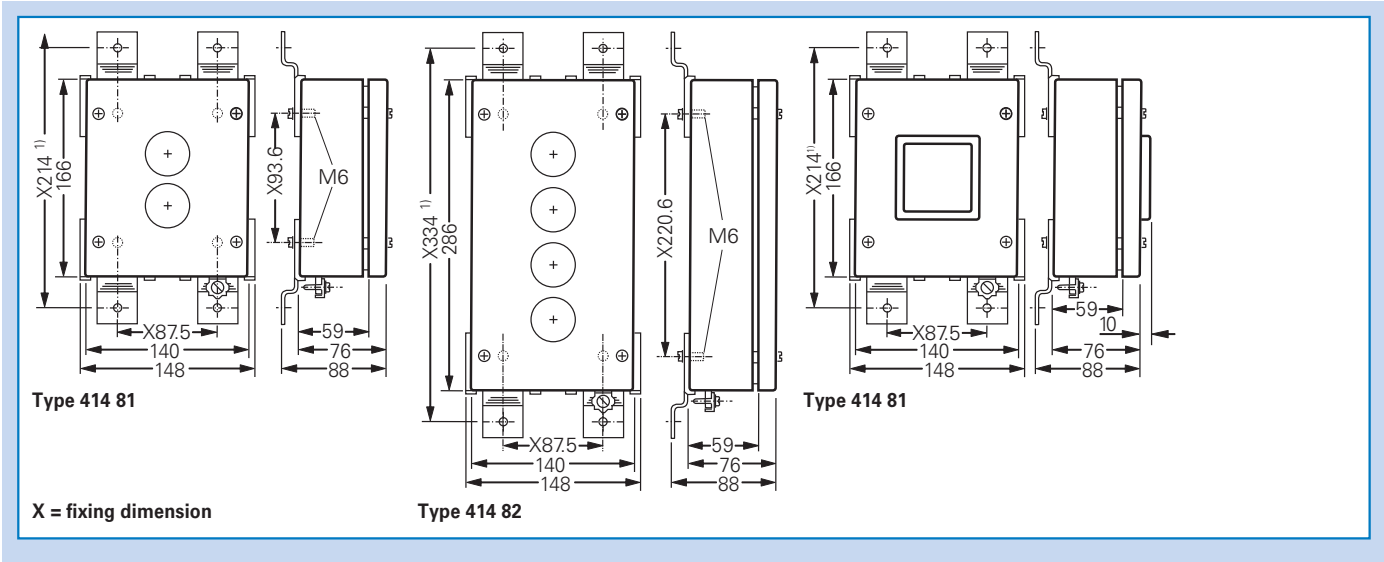

¹⁾ Scope of delivery without fixing lugs