

**Pow-R-Line Group-Mounted Distribution Switchboard**



<b>4.1</b>	<b>Group-Mounted Switchboards</b>	
	Pow-R-Line® Distribution Switchboards	
	Product Description .....	V2-T4-2
	Application Description .....	V2-T4-2
	Standards and Certifications .....	V2-T4-2
	Product Selection .....	V2-T4-2
	Commercial Metering Switchboards	
	Product Description .....	V2-T4-3
	Application Description .....	V2-T4-3
	Standards and Certifications .....	V2-T4-5
	Product Selection .....	V2-T4-5
	Technical Data and Specifications .....	V2-T4-5
<b>4.2</b>	<b>Integrated Facility Switchboards™</b>	
	Product Description .....	V2-T4-6
	Application Description .....	V2-T4-6
	Standards and Certifications .....	V2-T4-7
	Product Selection .....	V2-T4-7
<b>4.3</b>	<b>Pow-R-Line Drawout Molded Case Circuit Breaker Switchboards</b>	
	Product Description .....	V2-T4-8
	Application Description .....	V2-T4-8
	Standards and Certifications .....	V2-T4-8
	Product Selection .....	V2-T4-9
	Dimensions .....	V2-T4-10
	Options, Accessories and Modifications .....	V2-T4-13
<b>4.4</b>	<b>Compartmentalized Switchboards</b>	
	Pow-R-Line <i>i</i> Distribution Switchboards	
	Product Description .....	V2-T4-15
	Application Description .....	V2-T4-15
	Standards and Certifications .....	V2-T4-16
<b>4.5</b>	<b>Instant Service Switchboards</b>	
	Product Description .....	V2-T4-17
	Application Description .....	V2-T4-17
	Standards and Certifications .....	V2-T4-17
	Product Selection .....	V2-T4-18
	Accessories .....	V2-T4-20
	Technical Data and Specifications .....	V2-T4-21
	Dimensions .....	V2-T4-21
<b>4.6</b>	<b>Roll-Up Generator Termination Box</b>	
	Product Description .....	V2-T4-22
	Standards and Certifications .....	V2-T4-22
	Technical Data and Specifications .....	V2-T4-23
	Dimensions .....	V2-T4-36
<b>4.7</b>	<b>Power Xpert Multipoint Metering Switchboard</b>	
	Overview .....	V2-T4-37
	Product Description .....	V2-T4-37
	Application Description .....	V2-T4-37
	Standards and Certifications .....	V2-T4-38
	Product Selection .....	V2-T4-38



# Revision notes

## Volume 2—Commercial Distribution, CA08100003E

Tab 4—Switchboards

Revision date	Section	Change page(s)	Description
10/24/2017	—	V2-T4-1	Update Tab TOC
10/24/2017	4.1	V2-T4-2	Content edit
10/24/2017	4.3	V2-T4-9–V2-T4-13	Content edit
10/24/2017	4.7	V2-T4-36, V2-T4-39	Content edit
02/08/2018	All	All	Revision date changed to February 2018



*Powering Business Worldwide*

**Pow-R-Line Group-Mounted Distribution Switchboard**



### Contents

<i>Description</i>	<i>Page</i>
Pow-R-Line Distribution Switchboards	
Product Description . . . . .	<b>V2-T4-2</b>
Application Description . . . . .	<b>V2-T4-2</b>
Features, Benefits and Functions . . . . .	<b>V2-T4-2</b>
Standards and Certifications . . . . .	<b>V2-T4-2</b>
Product Selection . . . . .	<b>V2-T4-2</b>

### Pow-R-Line Distribution Switchboards

#### Product Description

Eaton's Pow-R-Line distribution switchboards combine a space-saving design with modular construction and increased system ratings to provide economical and dependable electrical system distribution and protection.

#### Application Description

Refer to Eaton's *Consulting Application Guide*.

#### Features, Benefits and Functions

- 6000A maximum main bus rating
- 600 Vac and below
- 600 Vdc and below
- Front or rear accessible
- Type 1 or Type 3R enclosures
- ANSI-61 gray powder coat paint finish
- Microprocessor-based metering and monitoring devices
- Utility metering provisions
- Surge protective devices (SPD)
- Ground fault protection on mains and distribution devices
- Busway and transformer connections
- Complete protective device accessory capability
- 65 kAIC bus bracing standard; optional 100 or 200 kAIC
- Standard tin-plated aluminum bus; optional copper- or silver-plated copper bus
  - Standard bus ampacities based on UL® heat test ratings. Optional density rated bus systems are also available

#### Main and Individually Mounted Devices

- Magnum® SB insulated case circuit breakers, 800–5000A, fixed or drawout
- Magnum DS power circuit breakers, 800–5000A, fixed or drawout
- Series NRXT™ insulated circuit breaker, 400–3000A, fixed or drawout
- Molded case circuit breakers, 400–2500A, fixed mounted
- Bolted pressure switches, 800–5000A
- FDPW fusible switches, 400–1200A

#### Group-Mounted Distribution Devices

- Molded case circuit breakers, 15–1200A
- FDPW fusible switches, 30–1200A

#### Standards and Certifications

- Meets NEMA® Standard PB-2 and UL 891
- Seismically qualified



#### Product Selection

For complete application and pricing information, contact your local Eaton sales office.

**Commercial Metering Switchboards**



**WWCMS**



**WCMS**

**Contents**

**Description**

Commercial Metering Switchboards  
 Features, Benefits and Functions . . . . .  
 Standards and Certifications . . . . .  
 Product Selection . . . . .  
 Technical Data and Specifications . . . . .

**Page**

**V2-T4-4**  
**V2-T4-5**  
**V2-T4-5**  
**V2-T4-5**

**Commercial Metering Switchboards**

**Product Description**

Eaton’s commercial metering switchboards provide electrical system distribution and metering for shopping centers, office buildings and other commercial multimetering applications.

Using standard Pow-R-Line construction and features, these switchboards incorporate metering sections with tenant feeder circuits using meter sockets to meet local utility or customer requirements.

All meter sockets and associated feeder devices are completely factory prewired and shipped ready for the installation of the meters.

**Application Description**

**Type WWCMS**

For EUSERC serviced areas. The self-contained meter sockets include a test bypass/disconnect block per EUSERC requirements, and are arranged, typically, for hot sequence metering.

**Type WCMS**

For other than EUSERC serviced areas. Self-contained meter sockets are provided with manual lever bypass and can be arranged for either hot or cold sequence metering.



**Socket and Test Block Assembly**

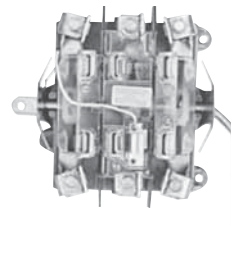

**Socket with Manual Lever Bypass**

Refer to Eaton’s *Consulting Application Guide*.

### Features, Benefits and Functions

Pow-R-Line designates a family of distribution switchboards, incorporating design concepts that fit the ever-increasing need for applications on high short-circuit systems, while retaining maximum safety and convenience throughout the line.

#### Front Accessible

Front-accessible switchboards align at the rear, enabling them to be placed against a wall (Pow-R-Line front accessible). If the main section is deeper than others, due to physical size of the main device, the necessary off-set in line-up will occur in front, and the main section will be accessible from the side as well as from the front. Standard front accessible switchboards will align at the front and rear.

#### Rear Accessible

Rear-accessible switchboards align at the front and the rear. Bus maintenance and cable entry and exit require rear access. There are two types of rear accessible switchboards. Both types use the same incoming utility and/or main structures. The first type uses group-mounted feeder devices with panel construction (Pow-R-Line rear accessible). The second type uses individually compartmentalized feeder devices with load side insulated bus bar extensions (Pow-R-Line *i*).

#### Standard Switchboard Height

Standard Pow-R-Line switchboard height is 90 inches (2286.0 mm).

#### Group Mounting

Group-mounted circuit protective devices are an assembly of units mounted on a panelboard type base (panelboard construction). Units may be molded case breakers, or FDPW fusible switches. Circuit protective devices are accessible from the front.

A main molded case breaker or main FDPW fusible switch, within the sizes listed for panelboard design, can be included in the panel-mounted assembly in lieu of a separate, individually mounted unit.

#### Space Only for Future Devices Group-Mounted Construction

Where space only for future circuit protective devices is required, the proper space and a blank filler plate will be supplied. Connections and mounting hardware are not included.

#### Provision for Future Devices

Where provisions for future circuit protective devices are required, space for the device, corresponding vertical bus, device connectors and the necessary mounting hardware will be supplied.

#### Bus Bar System

Standard bus in the switchboards is tin-plated aluminum. Copper and silver-plated copper are also available.

Main bus and sub-main buses meet UL and NEMA standards for temperature rise on all Pow-R-Line switchboards. Special bus densities are available.

#### Overcurrent Devices

To properly select and size overcurrent devices for use in a switchboard, the allowable temperature rise must be taken into account as to its effect on the tripping characteristics of the devices in question.

Accordingly, Article 220 of the NEC<sup>®</sup> requires overcurrent devices to be rated not less than 125% of the continuous load they are protecting. To comply with this, an 80% derating factor must be used with all overcurrent devices such as molded case breakers and FDPW fusible switches unless they are tested and marked as 100% rated devices.

#### Short-Circuit Rating

Standard bus and connectors on all switchboards are rated for use on systems capable of producing up to 65,000A rms symmetrical short-circuit current at the incoming terminals.

Increased bus short-circuit ratings equal to that of connected switchboard devices, up to 200,000A rms symmetrical, are available in most Pow-R-Line switchboards when approved main devices are installed. Contact Eaton for more information. UL labeled switchboard sections are marked with their applicable short-circuit rating.

#### Provision for Busway Entrance and Exit

Busway connections to switchboard sections include cutout and drilling in the top of the switchboard with riser connections from the switchboard device or bus, up to the point where the bus duct enters the switchboard. No connections are furnished external to the switchboard.

**Note:** In all transactions involving busway attached to switchboards, it is essential that information regarding orientation of the busway with respect to the front of the switchboard be supplied to the coordinating assembly plant.

On Pow-R-Line switchboards, solid bus bar is used to connect the bus duct to the individually mounted main device, main or sub-main switchboard bus, or vertical main bus of panel mounted circuit protective device panels. Busway fed by group-mounted branch devices are cable connected.

Aluminum riser connections are standard. Copper- or silver-plated copper is available as a modification.

#### Transitions

Transition structures are required for connecting switchboards to the secondary of power center transformer (dry or fluid filled), motor control centers, and for other special switchboard configurations such as "L" or "U" shaped lineups. In some application, an extra structure complete with connections is required; in others, where switchboard depth and space permit, only the connection conductors are required. Refer to factory for these applications.

**Standards and Certifications**

- UL 891
- NEMA PB-2
- Seismically qualified

**Product Selection**

For complete application and pricing information, contact your local Eaton sales office.

**Technical Data and Specifications****Service**

- 120/240V, single-phase, three-wire
- 240/120V, 208Y/120V, 415Y/240V, 480Y/277V or 600Y/347V three-phase, four-wire
- 600 Vdc

**Main Bus Rating**

- 400–4000A

**Service Section**

- Main circuit breaker, 400–4000A
- Main fusible switch, 400–4000A
- Main lugs only, 400–6000A

**Metering Sections**

- Tenant main disconnects and meter sockets (200A maximum self-contained metered circuits)
- Hot sequence metering circuits
- Cold sequence metering circuits (WCMS only)
- Optional rear barriered wireways or load side pull sections for cable exit requirements
- Sections for metered circuits larger than 200A available with 400A continuous rated self-contained sockets or with CT compartment and transformer rated socket in combination with disconnect

**Integrated Facility Switchboard**

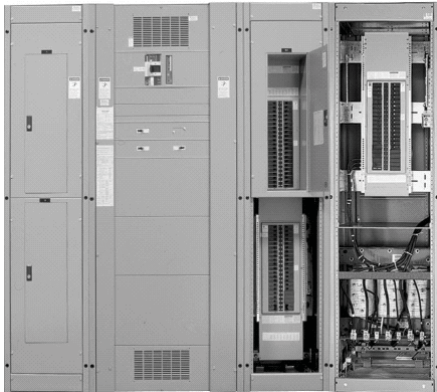

**Contents**

<i>Description</i>	<i>Page</i>
Integrated Facility Switchboards	
Features, Benefits and Functions . . . . .	<b>V2-T4-7</b>
Standards and Certifications . . . . .	<b>V2-T4-7</b>
Product Selection. . . . .	<b>V2-T4-7</b>



**Product Description**

Eaton’s Integrated Facility Switchboards use the modular Pow-R-Line group-mounted switchboard design to integrate traditionally separate electrical distribution and control equipment into a single space-saving factory assembled and connected package.

The service entrance equipment can be integrated with multiple lighting and appliance branch panelboards into a compact front-accessible group-mounted switchboard. Where multiple panelboards are used in the same electrical room as a conventional distribution switchboard or power panelboards, the integrated design will significantly reduce equipment space requirements, as well as reduce installation time and costs.

Other associated equipment can also be integrated into the assembly, including dry-type distribution transformers, Building Management Systems, Pow-R-Command™ lighting control system, electronic controls, surge protective devices, metering and energy monitoring devices. Depending upon the application, other user-defined equipment such as a subsystem control package may also be incorporated.

**Application Description**

Eaton’s Integrated Facility Switchboards are designed to meet specific needs for:

- Retail chain stores
- Commercial offices
- High rise buildings
- Correctional facilities
- Agricultural facilities
- Industrial facilities
- Hospitals/healthcare facilities
- Educational facilities

Whether the application is a multi-site prototype or single application, integrated switchboards offer time and space-saving features.

For complete application description, refer to Eaton’s *Consulting Application Guide*.

Features, Benefits and Functions

Front Accessible

Integrated Facility Switchboards are front accessible and align at the rear, enabling them to be placed against a wall. Most switchboards align at the front and the rear. If the main section is deeper than others, due to physical size of the main device, the necessary off-set in line-up will occur in front, and the main section will be accessible from the side as well as from the front.

Standard Switchboard Height

Switchboard height is 90 inches (2286.0 mm).

A limited offering of 78-inch (1981.2 mm) high equipment is available. Consult the factory for specific applications.

Switchboard Shipping Splits

The sections can be shipped as specified by the customer to meet specific requirements.

For retrofit applications, single-piece switchboard structures can be shipped to facilitate movement through limited access doorways, etc.

Factory Interconnections

Most sub-panels are fed from the main distribution panel feeder circuit breakers using copper cable sized per the NEC and UL.

Space Savings

The space-saving switchboard installation provides additional usable floor space. For example:

- Retail stores—floor space for sales
- Offices—additional storage, cubicle
- Healthcare—additional work area
- Retrofits—ability to fit existing rooms

Site Construction Savings

Timely installation of the electrical system typically is a key element on the critical path for any project.

Along with the time to install the equipment, other expenses include the time to handle all of the loose pieces of equipment arriving on a job site and ensuring it reaches the proper trades person. With Eaton’s Integrated Facility Switchboards, one piece of equipment is typically shipped to a job site virtually eliminating these issues.

The equipment may also be used for temporary power on job sites, further reducing construction expenses and times.

Standards and Certifications

- Meets NEMA Standard PB-2 and UL 891
- Panelboards mounted inside the sections meet NEMA PB-1 and UL 67
- Other equipment is UL listed as applicable and appropriate



Product Selection

For complete application and pricing information, contact your local Eaton sales office.



Traditionally Mounted Equipment

Construction Savings

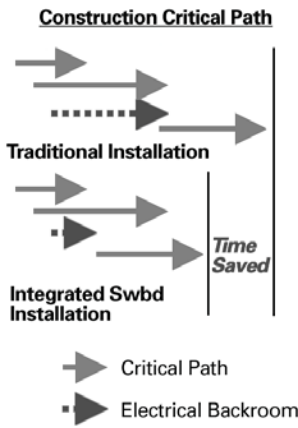



## Pow-R-Line Drawout Molded Case Circuit Breaker Switchboards



4

## Contents

<i>Description</i>	<i>Page</i>
Pow-R-Line Drawout Molded Case Circuit Breaker Switchboards	
Product Selection . . . . .	<b>V2-T4-9</b>
Dimensions . . . . .	<b>V2-T4-10</b>
Options, Accessories and Modifications . . . . .	<b>V2-T4-13</b>

## Product Description

- Drawout molded case circuit breaker switchboard
- Front accessible
- Front connected
- Through-the-door design drawout mechanism through 600A
- Insulated case UL 489 breakers up to 1200A
- Visual indication of breaker status and position
- Large grab handles for easy removal
- 600 Vac maximum
- 600A maximum, group-mounted, drawout molded case feeder breakers
- Individually mounted insulated UL 489 breakers through 1200A

## Application Description

- Drawout feeders in UL 891 distribution switchboards
- Rated as Service Entrance Equipment when appropriately equipped
- Ideal for:
  - Data centers
  - Industrial facilities
  - Process equipment manufacturing
  - Anywhere that requires quick change of feeder devices is needed

## Features, Benefits and Functions

Eaton's Pow-R-Line Drawout switchboard design is listed and labeled to the UL 891 standard. Switchboards may be rated up to 4000A. Main breakers are available up to 4000A in both fixed-mounted and drawout configurations. Main breakers may be Magnum DS® power circuit breakers or Magnum SB insulated case circuit breakers in either drawout or fixed-mounted configurations. Both are front-accessible configurations. Fixed-mounted molded case circuit breaker mains are available up through 2500A.

Utility and customer-owned metering is available. Customer metering includes Web-enabled communicating systems.

Aluminum bus is standard with copper and silver-plated copper optional. Other common options include surge protective devices (SPDs), seismically qualified designs, density rated bus and many more.

Drawout feeder MCCBs are available in two-pole and three-pole offerings from 20A to 600A in the high-density, group-mounted design.

Drawout feeders above 600A through 1200A integrate the molded case NX drawout breaker. Drawout breakers above 1200A through 2000A use the Magnum SB insulated case circuit breaker. All are front accessible and front connected.

## Standards and Certifications

- UL 891 listed



## Instructions

On an interim basis until Bid Manager™ is updated, please use the Pow-R-Line C® switchboard Bid Manager take-off as the basis for the following:

- Utility compartments
- Service entrance or non-service entrance information
- Voltage
- Bus rating
- Bus material
- Nameplate
- Ground bus material
- Short-circuit current rating
- Top or bottom entrance
- Incoming cable location
- Customer metering
- Surge protective device
- Bus bracing

Pow-R-Line Drawout Molded Case Circuit Breaker Switchboards

**Product Selection**

Select drawout molded case circuit breaker and UL 489 listed insulated case circuit breakers from the following pages.

- Always select front access/rear aligned
- IFS sections are permissible but will be bolt-on devices only
- Use the existing Pow-R-Line C switchboard take-off to select main devices

**Drawout Branch/Feeder Breakers**

**Single Branch/Feeder**



**Dual Branch/Feeder**



**Single-Mount Two-Pole and Three-Pole**

Ampere Rating	Interrupting Rating (kA Symmetrical)			Breaker Type	"X" Space
	240 Vac	480 Vac	600 Vac		
<b>Single-Mount Breakers with Thermal-Magnetic Trip Units</b>					
70–250	85	35	18	JGS	7X
70–250	100	65	25	JGH	7X
70–250	200	100	35	JGC	7X
250–600	85	35	18	LGS	9X
250–600	100	65	35	LGH	9X
250–600	200	100	50	LGC	9X
<b>Single-Mount Breakers with Electronic 310+ Trip Units (Three-Pole Only)</b>					
20–50	85	35	18	JGS	7X
20–50	100	65	25	JGH	7X
20–50	200	100	35	JGC	7X
40–100	85	35	18	JGS	7X
40–100	100	65	25	JGH	7X
40–100	200	100	35	JGC	7X
80–150	85	35	18	JGS	7X
80–150	100	65	25	JGH	7X
80–150	200	100	35	JGC	7X
100–250	85	35	18	JGS	7X
100–250	100	65	25	JGH	7X
100–250	200	100	35	JGC	7X
100–250	85	35	18	LGS	9X
100–250	100	65	35	LGH	9X
100–250	200	100	50	LGC	9X
200–400	85	35	18	LGS	9X
200–400	100	65	35	LGH	9X
200–400	200	100	50	LGC	9X
250–600	85	35	18	LGS	9X
250–600	100	65	35	LGH	9X
250–600	200	100	50	LGC	9X
<b>Single-Mount 310+ Electronic Trip Unit</b>					
500–1200	85	50	25	NGS	12X
500–1200	100	65	35	NGH	12X
500–1200	200	100	65	NGC	12X
<b>Provision for Future (Includes Factory-Installed Base Cassette)</b>					
20–250	Any JG family branch/feeder breaker				7X
100–600	Any LG family branch/feeder breaker				9X

# 4.3

## Switchboards

### Pow-R-Line Drawout Molded Case Circuit Breaker Switchboards

#### Dimensions

Approximate Dimensions in Inches (mm)

Select the appropriate distribution section(s) for drawout MCCB feeder devices from the sections shown below.

All breakers are front accessible and front connected.

4

#### Drawout Molded Case Circuit Breaker Feeder Devices

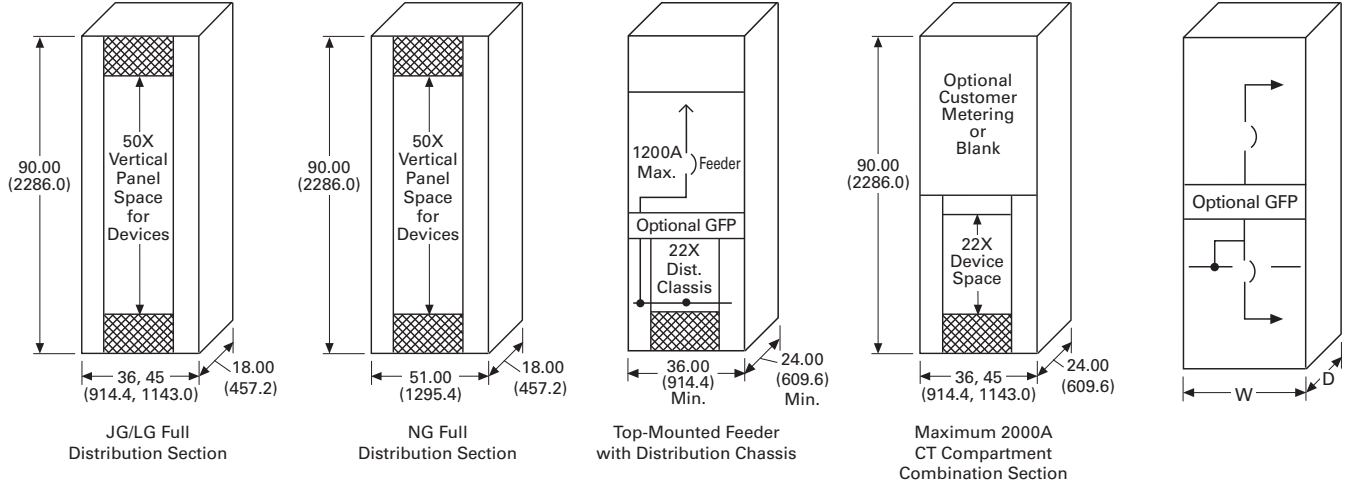

#### Notes

All four sections widths 36-inch minimum.

See distribution layout Guides **Page V2-T4-11** for actual minimum structure width and for feeder device "X" requirements.

Pow-R-Line Drawout Molded Case Circuit Breaker Switchboards

Layout for Group-Mounted Drawout Molded Case Circuit Breaker Feeder Devices

Instructions

Determine the structure width by the group-mounted drawout MCCB feeder devices below. The width of the structure is determined by the maximum structure size shown for each device.

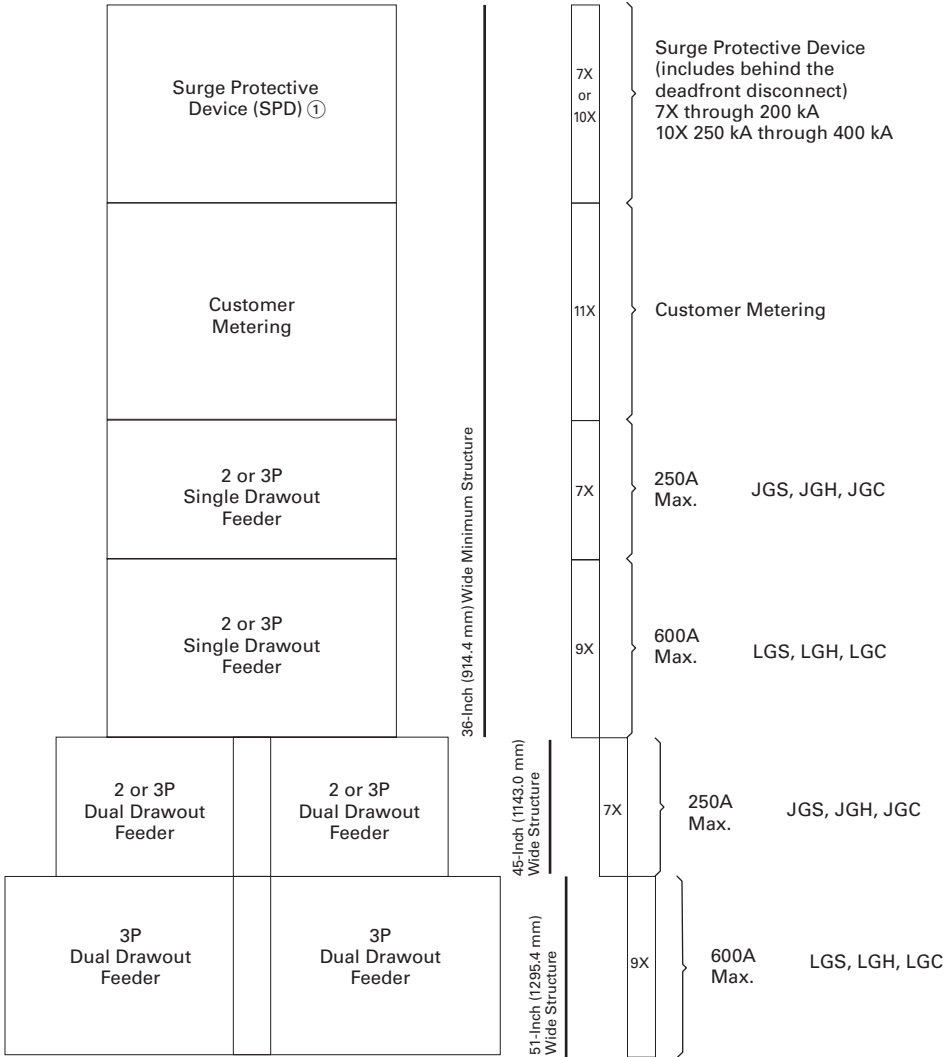

Note

① Preferred location of SPD is mounted at the top of the first distribution section.

# 4.3

## Switchboards

### Pow-R-Line Drawout Molded Case Circuit Breaker Switchboards

#### NG Molded Case Drawout Chassis

##### Instructions

Determine the structure width by the group-mounted drawout MCCB feeder devices below. The width of the structure is determined by the maximum structure size shown for each device.

4

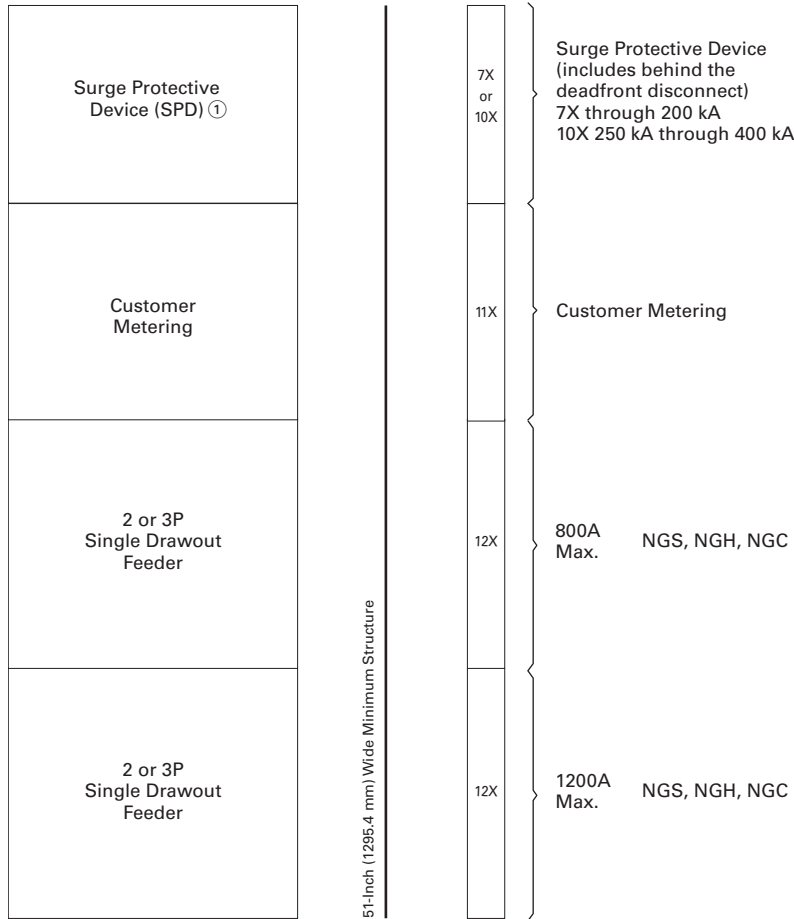

##### Note

① Preferred location of SPD is mounted at the top of the first distribution section.

**Options, Accessories and Modifications**

**1. Ambient Compensating Breakers**

For ambient compensating breakers (where available) in lieu of standard breakers, add 10% to panelboard branch breaker and to main breaker list prices, when required. Panels with this option can not be UL listed.

**2. JG and LG Breaker Accessories—Internal (Only One Accessory Per Position)**

**Accessories**

Breaker Type	Device Mounting	Internal Breaker Accessory
JG family	Drawout ①	Auxiliary switch 1A-1B
JG family	Drawout ①	Auxiliary switch 2A-2B
JG family	Drawout ①	Bell alarm
JG family	Drawout ①	High load alarm w/trip
JG family	Drawout ①	Ground fault alarm w/trip
JG family	Drawout ②	Undervoltage release
JG family	Drawout ②	Zone selective interlock
LG family	Drawout ①	Auxiliary switch 1A-1B
LG family	Drawout ①	Auxiliary switch 2A-2B
LG family	Drawout ①	Bell alarm
LG family	Drawout ①	High load alarm w/trip
LG family	Drawout ①	Ground fault alarm w/trip
LG family	Drawout ②	Undervoltage release ③
LG family	Drawout ②	Zone selective interlock

**Notes**

- ① Accessories wired to a pull-apart terminal block. Right position only.
- ② Accessories wired to a pull-apart terminal block. Left position only.
- ③ Not available when breaker is equipped with ARMS trip unit.

**3. Drawout NG Breaker Accessories Internal**

**Accessories**

**Internal NG Breaker Accessories**

Drawout ①	Auxiliary switch 1A-1B
Drawout ①	Auxiliary switch 2A-2B
Drawout ①	Bell alarm
Drawout ①	High load alarm with trip
Drawout ①	Ground fault alarm with trip
Drawout ②	Undervoltage release ③
Drawout ②	Zone selective interlock

**4. Compression Main Lugs**

Al/Cu Burndy Range Taking Type.

**Modification 4**

Main Lug Amperes	PRL4D Lug Wire Range
800	(3) 500–750 kcmil
1200	(4) #2–600 kcmil (4) 500–750 kcmil

**5. Copper Lugs/Terminals**

Optional copper mechanical main lugs only and includes main incoming neutral lug.

**Modification 5**

Main Lug Amperes	PRL4D Lug Wire Range
600	(2) 1/0–600 kcmil
800	(2) 1/0–600 kcmil
1200	(3) 1/0–600 kcmil

**6. Copper Main Busbars**

Optional copper busbars are available in all ampere ratings.

**Modification 6**

Ampere Range	Bare Copper Chassis Bus	Silver-Plated Copper Bus
800		
1200		
1600		
2000		
2500		
3000		
4000		

**7. Density Rated Bus**

Standard main bus ampere rating is determined by UL listed temperature rise testing. Density rated bus is defined at 750A per square inch for aluminum bus and 1000A per square inch for copper bus. Adder for aluminum density rated bus is in addition to the base price. Adder for copper density rated bus is in addition to the base price plus the appropriate adder for copper bus. See Modification 7.

**Modification 7**

Ampere Rating	Aluminum – 750A per Square Inch
800	
1200	
1600	
2000	
2500	
3000	
4000	

**Copper – 1000A per Square Inch**

800
1200
1600
2000
2500
3000
4000

**8. Electronic Trip Units**

Thermal-magnetic trip units are standard. For electronic trip units, select appropriate breaker from the electronic trip section of **Pages V2-T4-9** and **V2-T4-11**. See selection below for electronic trip units.

**Modification 8**

Breaker Frame Family	Trip Unit Type
Drawout Feeder JGS, JGH, JGC	Digitrip 310+ LS
	Digitrip 310+ LSI
	Digitrip 310+ LSG
	Digitrip 310+ LSIG
LGS, LGH, LGC Drawout	310+ LS
	310+ LSI
	310+ LSG
	310+ LSIG
	310+ w/GFA LSA
	310+ w/GFA LSIA
	310+ w/Arcflash ALSI
	310+ w/Arcflash ALSIG
	310+ w/ZSI LSI
	310+ w/ZSI LSIG
	310+ w/ZSI, Arcflash ALSI
	310+ w/ZSI, Arcflash ALSIG
NG Drawout	310+ LS
	310+ LSI
	310+ LSG
	310+ LSIG
	310+ w/GFA LSA
310+ w/GFA LSIA	
310+ w/Arcflash ALSI	
310+ w/Arcflash ALSIG	
310+ w/ZSI LSI	
310+ w/ZSI LSIG	
310+ w/ZSI, Arcflash ALSI	
310+ w/ZSI, Arcflash ALSIG	

**Notes**

- L = Adjustable long time pickup
- S = Adjustable short time pickup w/fixed short time delay
- I = Adjustable instantaneous pickup
- G = Adjustable ground fault pickup
- A = Adjustable ground fault alarm only (no trip)
- Arcflash = Arcflash Reduction Maintenance System
- ZSI = Zone selective interlocking

- ① Accessories wired to a pull-apart terminal block. Right position only.
- ② Accessories wired to a pull-apart terminal block. Left position only.
- ③ Not available when breaker is equipped with Arcflash Reduction Maintenance System trip unit.

#### 9. Ground Bus

Copper or silver-plated copper ground bus in lieu of standard aluminum.

#### Modification 9

Bus Material	Size in Inches (mm)
Copper	0.25 (6.4) x 1.50 (38.1)
	0.25 (6.4) x 2.00 (50.8)
Silver-plated copper	0.25 (6.4) x 1.50 (38.1)
	0.25 (6.4) x 2.00 (50.8)

#### 10. Ground Fault Protection

Refer to Modification 8 for ground fault trip units.

#### 11. Infrared (IR) Viewing Windows

Infrared viewing windows for main devices and drawout single-mounted feeder devices.

#### Modification 11

Overcurrent Device	IR Window Manufacturer
All fixed mount mains	Iriss Hawk (Fluke)
Single drawout feeder breakers ①	Iriss Hawk (Fluke)

#### 12. Nameplates, Engraved

Field-attached nameplates.

#### Modification 12

##### Description

Mastic back, engraved, black with white lettering

Mastic back, engraved, colors other than black

Nameplates, screw attached

#### 13. Seismically Qualified

For seismically qualified PRL drawout switchboard, request seismic labeling on order.

#### 14. Service Entrance Equipment

Service Entrance labeling as detailed under the “Service Entrance Equipment” per UL and NEC. Only switchboards meeting these requirements may be labeled as such. The requirement or service entrance labeling must be noted on the order. Includes neutral disconnect link and labeling “Suitable Only For Use as Service Equipment” (SUSE).

#### 15. Surge Protective Devices (SPD)

Package includes SPD unit and integral circuit breaker disconnect (30A) connected to the chassis bus.

#### Modification 15

Surge Current Rating	50	80	100	120	160	200	250	300	400
----------------------	----	----	-----	-----	-----	-----	-----	-----	-----

##### SPD Package Options—Basic Package

LED monitor, L-N, L-G, L-L and N-G	■	■	■	■	■	■	■	■	■
------------------------------------	---	---	---	---	---	---	---	---	---

##### Standard Package

LED monitor, L-N, L-G, L-L and N-G. EMI/RFI filtering. Audible alarm with disable switch. Form C relay contact.	■	■	■	■	■	■	■	■	■
---	---	---	---	---	---	---	---	---	---

##### Premium Package

LED monitor, L-N, L-G, L-L and N-G. EMI/RFI filtering. Audible alarm with disable switch. Form C relay contact. Six-digit LCD display. Counts surges in all modes. Nonvolatile memory (no battery backup). Reset button designed to prevent accidental resets.	■	■	■	■	■	■	■	■	■
--	---	---	---	---	---	---	---	---	---

#### 16. Touchup Paint

#### Modification 16

##### Description

12 oz spray can. ANSI-61 light gray indoor

Case lot of 12—12 oz spray can. ANSI-61 light gray indoor

##### Note

① Available on only single-mounted drawout. Not available on dual-mounted feeder devices.

Compartmentalized Feeder Sections



Front View—Circuit Breakers



Front View—Fusible Units

Contents

Description

Page

Compartmentalized Switchboards	
Standards and Certifications . . . . .	V2-T4-16

Product Description

Eaton’s Pow-R-Line *i* switchboards are engineered in a new compartmentalized design for applications where a greater degree of safety is required. A wide variety of configurations is possible, including utility metering, customer metering, main devices, branch devices, accessories and enclosures.

Application Description

Refer to Eaton’s *Consulting Application Guide*.

Features, Benefits and Functions

Significant safety features include:

- Individual compartments for branch devices—glass polyester for circuit breakers and steel for fusible switches. These compartments help eliminate possible contact with the main bus and reduce fault propagation
- Three-section construction with each section barriered from the other
  - Device section—each device is mounted in its own compartment
  - Bus bar section—contains both horizontal and vertical buses
  - Rear cable compartment—completely isolated from the bus bars
- Insulated copper runback. Power is taken from the protective device by the insulated copper runback through a standard full height glass polyester barrier to the rear cable compartment. This design virtually eliminates the possibility of accidental contact with the main buses during installation or maintenance

Main devices are available from 400–4000A and can include molded case circuit breakers, Magnum SB, Magnum DS circuit breakers, FDPW fusible switches or bolted pressure switches. Main buses are rated up to 6000A.

Branch circuit breakers range from 15–1200A frames. When circuit breakers are used, higher ratings and increased series ratings will be achieved. Branch fusible switches are available from 100–1200A.

Interrupting ratings up to 200,000A are UL listed and the bus bar system may be braced from a standard 65,000A up to a maximum 200,000A.

Integrated Monitoring Protection and Control Communications Systems

The capabilities of distribution and control assemblies can be expanded by tying together multiple devices in electrical distribution systems. From a central location (on-site or off-site), an operator uses a personal computer (master control unit) to monitor, control and communicate with compatible devices on a distribution system. These microprocessor-based devices, designed and built by Eaton, perform monitoring, protection and control functions.



**Ground Fault Test Panels**

Pow-R-Line *i* switchboards can accommodate either integral or zero sequence types of ground fault protection. Depending on the specific application, a test panel can be mounted in the circuit breaker compartment, which may eliminate the need for an auxiliary structure.

**Fusible Switches**

Pow-R-Line *i* switchboards have been designed to accommodate fusible switches. Safety is provided by steel compartments that insulate each horizontally mounted switch from the vertical and main buses. As with switchboards using circuit breakers, insulated copper runbacks carry power into the spacious, glass polyester barriered rear cable compartment.

**UL Listed Shunt Trip and Fusible Switches**

Shunt trip attachments for use with ground fault protection devices can be installed on 400–1200A Type FDPW fusible switches. Both are UL listed when the shunt trip is factory installed.

**High Durability Finish**

A baked-on polyester powder coating system protects all structural steel parts. It provides excellent mechanical strength and resistance to chalking normally caused by the sun's ultraviolet rays and meets the salt spray requirements of ASTM B-117.

**Pow-R-Line *i* Quality Assurance**

Final testing helps ensure that each Pow-R-Line *i* switchboard performs in accordance with UL standards and customer specifications. Each assembly is shipped with a "Switchboard Verification Report" that documents completion of every inspection and test.

**Provisions for the Future**

Future expansion provisions include line side connectors, load side runbacks, terminals, and glass polyester compartments and covers (for circuit breakers). Space only for "both circuit breakers and fusible switches is also available.

**Standards and Certifications**

Pow-R-Line *i* switchboards are UL 891 listed and meet all applicable requirements of NEMA and NEC. They are rear accessible and front and rear aligned. Both indoor and outdoor enclosures are available.

- Meets NEMA Standard PB-2 and UL 891
- Seismically qualified



Instant Service Switchboards



Type 1 Indoor



Type 3R Outdoor

Contents

<i>Description</i>	<i>Page</i>
Instant Service Switchboards	
Product Selection . . . . .	<b>V2-T4-18</b>
Accessories . . . . .	<b>V2-T4-20</b>
Technical Data and Specifications . . . . .	<b>V2-T4-21</b>
Dimensions . . . . .	<b>V2-T4-21</b>

**Product Description**

Eaton’s Instant® Service Switchboards are designed as stocked units to provide fast delivery to match the needs of the construction market.

Suitable for use as service entrance equipment, they combine utility metering provisions with a fused main switch in a single compact section that can also include a distribution panel for feeder and branch circuit breakers.

**Application Description**

Typical applications for these versatile switchboards include small office buildings and factories, stores, supermarkets and shopping centers.

**Features, Benefits and Functions**

These switchboards are available in either indoor or outdoor enclosures manufactured of code-gauge steel with a durable light gray finish. All units are completely enclosed with front, rear and side covers. Outdoor units include a front hinged door.

The service section includes:

- Main lugs mounted at the top (two #4–600 kcmil per phase) for overhead feed or for use with an underground pull section
- A sealable metering and CT compartment with bussing for utility bar type CTs and two 15-inch (381.0 mm) high meter compartment doors—one with provisions for meter socket and test block, one blank (meter socket is ordered separately)
- A 400 or 600A T-Type fused main switch or 400, 600 or 800A main circuit breaker with either load lugs (same as main lugs) or with connections to a factory installed distribution panel

Underground pull sections are available with lug landing kits providing studs for incoming cables per EUSERC standards and

two #4–600 kcmil lugs per phase for cable connection to the service section.

Distribution panels can be included for 240 Vac maximum (single-phase three-wire or three-phase four-wire), 480Y/277 Vac (three-phase four-wire) or 480 Vac (three-phase three-wire). The 240V panels have provisions for four Type ED 225A frame circuit breakers and 24 poles of Type BAB 100A frame circuit breakers. The 480Y/277V panel has provisions for four Type FD 225A frame circuit breakers and 24 poles of Type GHB 100A frame circuit breakers. The bolt-on type circuit breakers are ordered separately.

For applications that require the load circuit conductors to exit at the top, a loadside wireway compartment is available that bolts to the service section.

Standard switchboards include two 15.00-inch (381.0 mm) high meter compartment doors, one with meter socket provisions and one blank. For other arrangements, accessory units are available. Check utility requirements.

**Standards and Certifications**

Eaton’s Instant Service Switchboards are listed by Underwriters Laboratories and comply with all applicable industry standards.

These switchboards meet EUSERC standards as well as other local utility codes.

**Seismic Qualified**

Eaton’s Instant Service Switchboards are seismically tested, seismically qualified and meet or exceed requirements of the Uniform Building Code® (UBC), the California Building Code (CBC) and the International Building Code (IBC) for all seismic zones.



## Product Selection

### Main Fused Switch Only

Service	Main Ampere Rating	Type 1—Indoor Catalog Number	Type 3R—Outdoor Catalog Number
<b>240 Vac Maximum</b>			
Single-phase three-wire	400	<b>MSB423</b>	<b>RMSB423</b>
	600	<b>MSB623</b>	<b>RMSB623</b>
Three-phase four-wire	400	<b>MSB424</b>	<b>RMSB424</b>
	600	<b>MSB624</b>	<b>RMSB624</b>
<b>480Y/277 Vac</b>			
Three-phase four-wire	400	<b>MSB444</b>	<b>RMSB444</b>
	600	<b>MSB644</b>	<b>RMSB644</b>

### Main Fused Switch with Distribution Panel

Service	Main Ampere Rating	Type 1—Indoor Catalog Number	Type 3R—Outdoor Catalog Number
<b>240 Vac Maximum <sup>①</sup></b>			
Single-phase three-wire	400	<b>MSBP423</b>	<b>RMSBP423</b>
	600	<b>MSBP623</b>	<b>RMSBP623</b>
Three-phase four-wire	400	<b>MSBP424</b>	<b>RMSBP424</b>
	600	<b>MSBP624</b>	<b>RMSBP624</b>
<b>480Y/277 Vac <sup>②</sup></b>			
Three-phase four-wire	400	<b>MSBP444</b>	<b>RMSBP444</b>
	600	<b>MSBP644</b>	<b>RMSBP644</b>

### Main Breaker Switch Only

Service	Main Ampere Rating	Type 1—Indoor Catalog Number	Type 3R—Outdoor Catalog Number
<b>240 Vac Maximum <sup>①</sup></b>			
Single-phase three-wire	400	<b>MBB423</b>	<b>RMBB423</b>
	600	<b>MBB623</b>	<b>RMBB623</b>
	800	<b>MBB823</b>	<b>RMBB823</b>
Three-phase four-wire	400	<b>MBB424</b>	<b>RMBB424</b>
	600	<b>MBB624</b>	<b>RMBB624</b>
	800	<b>MBB824</b>	<b>RMBB824</b>
<b>480Y/277 Vac <sup>②</sup></b>			
Three-phase four-wire	400	<b>MBB444</b>	<b>RMBB444</b>
	600	<b>MBB644</b>	<b>RMBB644</b>
	800	<b>MBB844</b>	<b>RMBB844</b>

#### Notes

- ① 240V distribution panels have double branch provisions for four Type ED 225A frame circuit breakers and 24 poles of Type BAB 100A frame circuit breakers.
- ② 480Y/277V distribution panels have double branch provisions for four Type FD 225A frame circuit breakers and 24 poles of Type GHB 100A frame circuit breakers.

Circuit breakers for distribution panels are ordered separately.

### Main Breaker Only with Distribution Panel

Service	Main Ampere Rating	Type 1—Indoor Catalog Number	Type 3R—Outdoor Catalog Number
<b>240 Vac Maximum</b>			
Single-phase three-wire	400	<b>MBBP423</b> ①	<b>RMBBP423</b> ①
	600	<b>MBBP623</b> ①	<b>RMBBP623</b> ①
	800	<b>MBBP823</b> ②	<b>RMBBP823</b> ②
	800	<b>MBBP823-P</b> ③	<b>RMBBP823-P</b> ③
	800	<b>MBBP823-K</b> ④	<b>RMBBP823-K</b> ④
Three-phase four-wire	400	<b>MBBP424</b> ①	<b>RMBBP424</b> ①
	600	<b>MBBP624</b> ①	<b>RMBBP624</b> ①
	800	<b>MBBP824</b> ②	<b>RMBBP824</b> ②
	800	<b>MBBP824-P</b> ③	<b>RMBBP824-P</b> ③
	800	<b>MBBP824-K</b> ④	<b>RMBBP824-K</b> ④
<b>480Y/277 Vac</b>			
Three-phase four-wire	400	<b>MBBP444</b> ⑤	<b>RMBBP444</b> ⑤
	600	<b>MBBP644</b> ⑤	<b>RMBBP644</b> ⑤
	800	<b>MBBP844</b> ②	<b>RMBBP844</b> ②
	800	<b>MBBP844-K</b> ④	<b>RMBBP844-K</b> ④

### Underground Pull Sections—Same Depth as Switchboard with Provisions for Lug Landing Kit

Section Width Inches (mm)	Type 1—Indoor Catalog Number	Type 3R—Outdoor Catalog Number
24.00 (609.6) ⑥	<b>UG24W</b>	<b>RUG24W</b>
30.00 (762.0)	<b>UG30W</b>	<b>RUG30W</b>

NEMA Type 1 pull section can be installed separate from service section. Add side closer plate, catalog number UGCP.

### Lug Landing Kits for Underground Pull Sections

Maximum Ampere Rating	Service	Catalog Number
400	Single-phase three-wire	<b>LL4003</b>
	Three-phase four-wire	<b>LL4004</b>
800	Single-phase three-wire	<b>LL8003</b> ⑦
	Three-phase four-wire	<b>LL8004</b> ⑦

### Load Side Wireway—12 Inches (304.8 mm) Wide Same Depth as Switchboard

Type	Catalog Number
Type 1—Indoor	<b>LSS12W</b>
Type 3R—Outdoor	<b>RLSS12W</b>

#### Notes

- ① 240V distribution panels have double branch provisions for four Type ED 225A frame circuit breakers and 24 poles of Type BAB 100A frame circuit breakers.
- ② 800A distribution panels have double branch provision for six Type FD 225A frame circuit breakers only.
- ③ Suffix-P: four Type FD 225A frame circuit breakers and 24 poles of Type GHB 100A frame circuit breakers.
- ④ Suffix-K: one Type KD OR HKD 400A frame circuit breakers and four Type FD 225A frame circuit breakers.
- ⑤ 480Y/277V distribution panels have double branch provisions for four Type FD 225A frame circuit breakers and 24 poles of Type GHB 100A frame circuit breakers.
- ⑥ Check utility requirements—most EUSERC utilities require 30-inch (762.0 mm) width.
- ⑦ Mounts in 30-inch (762.0 mm) wide section only.

Circuit breakers for distribution panels are ordered separately.

## Accessories

### Meter Compartment Doors—(Meter Sockets Not Included)

Height	Width	Drilling	Catalog Number
15.00 (381.0)	32.00 (812.8)	Blank	<b>MD150</b>
		One socket	<b>MD151</b>
30.00 (762.0)	32.00 (812.8)	Blank	<b>MD300</b>
		Two sockets	<b>MD302</b>

### Meter Sockets—For Field Installation

Number of Jaws	Catalog Number	Number of Jaws	Catalog Number
4	<b>M4</b>	8	<b>M8</b>
5 <sup>①</sup>	<b>M5</b>	13	<b>M13</b>
6 <sup>②</sup>	<b>M6</b>	15 <sup>③</sup>	<b>M15</b>

### Circuit Breakers for Distribution Panels 240 Vac Three-Phase Four-Wire Maximum

Ampere Rating	Single-Pole 120/240 Vac Catalog Number	Two-Pole 120/240 Vac Catalog Number	Two-Pole 240 Vac Catalog Number	Three-Pole 240 Vac Catalog Number
15	<b>BAB1015I</b>	<b>BAB2015I</b>	<b>BAB2015HI</b>	<b>BAB3015HI</b>
20	<b>BAB1020I</b>	<b>BAB2020I</b>	<b>BAB2020HI</b>	<b>BAB3030HI</b>
30	<b>BAB1030I</b>	<b>BAB2030I</b>	<b>BAB2030HI</b>	<b>BAB3030HI</b>
40	<b>BAB1040I</b>	<b>BAB2040I</b>	<b>BAB2040HI</b>	<b>BAB3040HI</b>
50	<b>BAB1050I</b>	<b>BAB2050I</b>	<b>BAB2050HI</b>	<b>BAB3050HI</b>
60	<b>BAB1060I</b>	<b>BAB2060I</b>	<b>BAB2060HI</b>	<b>BAB3060HI</b>
70	—	<b>BAB2070I</b>	<b>BAB2070HI</b>	<b>BAB3070HI</b>
90	—	<b>BAB2090I</b>	<b>BAB2090HI</b>	<b>BAB3090HI</b>
100	—	<b>BAB2100I</b>	<b>BAB2100HI</b>	<b>BAB3100HI</b>
100	—	—	<b>ED2100I</b>	<b>ED3100I</b>
125	—	—	<b>ED2125I</b>	<b>ED3135I</b>
150	—	—	<b>ED2150I</b>	<b>ED3150I</b>
175	—	—	<b>ED2175I</b>	<b>ED3175I</b>
200	—	—	<b>ED2200I</b>	<b>ED3200I</b>
225	—	—	<b>ED2225I</b>	<b>ED2225I</b>
300	—	—	<b>KD2300I</b>	<b>KD3300I</b>
350	—	—	<b>KD2350I</b>	<b>KD3350I</b>
400	—	—	<b>KD2400I</b>	<b>KD3400I</b>

### Circuit Breakers for Distribution Panels 480Y/277 Vac (Three-Phase Four-Wire)

Ampere Rating	Single-Pole Catalog Number	Two-Pole Catalog Number	Three-Pole Catalog Number
15	<b>GHB1015I</b>	<b>GHB2015I</b>	<b>GHB3015I</b>
20	<b>GHB1020I</b>	<b>GHB2020I</b>	<b>GHB3030I</b>
30	<b>GHB1030I</b>	<b>GHB2030I</b>	<b>GHB3030I</b>
40	<b>GHB1040I</b>	<b>GHB2040I</b>	<b>GHB3040I</b>
50	<b>GHB1050I</b>	<b>GHB2050I</b>	<b>GHB3050I</b>
60	<b>GHB1060I</b>	<b>GHB2060I</b>	<b>GHB3060I</b>
70	—	<b>GHB2070I</b>	<b>GHB3070I</b>
90	—	<b>GHB2090I</b>	<b>GHB3090I</b>
100	—	<b>GHB2100I</b>	<b>GHB3100I</b>
100	—	<b>FD2100I</b>	<b>FD3100I</b>
125	—	<b>FD2125I</b>	<b>FD3135I</b>
150	—	<b>FD2150I</b>	<b>FD3150I</b>
175	—	<b>FD2175I</b>	<b>FD3175I</b>
200	—	<b>FD2200I</b>	<b>FD3200I</b>
225	—	<b>FD2225I</b>	<b>FD2225I</b>
300	—	<b>HKD2300I</b>	<b>HKD3300I</b>
350	—	<b>HKD2350I</b>	<b>HKD3350I</b>
400	—	<b>HKD2400I</b>	<b>HKD3400I</b>

### Special Utility Options—Select for the Following Utilities

Utility Company	Catalog Number
City of Anaheim	<b>ISTAHEIM</b>
City of Burbank	<b>ISTBANK</b>

### Special Bus Options

Maximum Ampere Rating	Catalog Number
<b>Density Bus Kit</b>	
400	<b>DBK400</b>
600	<b>DBK600</b>
800	<b>DBK800</b>
<b>Copper Bus Kit</b>	
400	<b>CUK400</b>
600	<b>CUK600</b>
800	<b>CUK800</b>

#### Notes

- ① 240V distribution panels have double branch provisions for four Type ED 225A frame circuit breakers and 24 poles of Type BAB 100A frame circuit breakers.
- ② 800A distribution panels have double branch provision for six Type FD 225A frame circuit breakers only.
- ③ Suffix-P: four Type FD 225A frame circuit breakers and 24 poles of Type GHB 100A frame circuit breakers.

### Technical Data and Specifications

- 120/240 Vac, single-phase three-wire
- 208Y/120V or 240/120 Vac, three-phase four-wire
- 240 Delta/120 Vac, three-phase four-wire
- 480Y/277 Vac, three-phase four-wire
- 480 Vac, three-phase three-wire

### Interrupting Ratings (Series Rating)

- 65,000 rms symmetrical amperes at 240 Vac, using Types BAB and ED branch circuit breakers
- 65,000 rms symmetrical amperes at 480Y/277 Vac, using Types GHB and FD branch circuit breakers

### Dimensions

Approximate Dimensions in Inches (mm)

#### Instant Service Switchboards

Height	Width	Depth
<b>Indoor</b>		
90.00 (2286.0)	32.00 (812.8)	14.00 (355.6)
<b>Outdoor</b>		
90.00 (2286.0)	38.00 (965.2)	26.00 (660.4)

## Roll-Up Generator Termination Box



4

### Product Description

Eaton's roll-up generator termination boxes (RUGTB) are designed as an intermediate termination cabinet between temporary, portable roll-up generator and the facility being served. The RUGTB is designed for permanent installation and is secured to a concrete pad with bolts.

The RUGTB includes line terminations for the temporary connection of the portable generator and permanent connections on the load side to the secondary disconnect in the facility, which is interlocked with the main overcurrent device in a manner that ensures that only one (either the service main or the generator main) can be energized at any one time. The conductors and conduits must be sized and suitable for carrying the load ratings marked on the equipment per the National Electrical Code.

### Features

#### Enclosure

The enclosure is free-standing with feet on the bottom, providing access to the cable connections for temporary roll-up generator terminations. The enclosure is made from code gauge steel and is suitable for either outdoor or indoor installation (Type 3R construction). The enclosure is powder coat painted ANSI 61 gray. Each enclosure houses line and load phase, neutral and ground connections. Access is provided at the bottom of the enclosure for both the temporary connections to the roll-up generator and permanent connections to the facility's generator overcurrent disconnecting means. The permanent connection section at the bottom of the enclosure contains a fixed mounting plate. The temporary generator connection to the RUGTB contains a hinged cover that allows access to the enclosure for generator conductors.

### Contents

<i>Description</i>	<i>Page</i>
Roll-Up Generator Termination Box	
Technical Data and Specifications . . . . .	<b>V2-T4-23</b>
Dimensions . . . . .	<b>V2-T4-36</b>

The enclosure uses feet that raise the termination compartment off finished grade by 18 inches (457.2 mm). Enclosure feet have provisions for anchoring the RUGTB. Anchor bolts secure the RUGTB and shall be encased in a concrete pad by the installer in a manner that is suitable as a permanent base for the unit. A template for anchor bolt installation is available from the manufacturer.

The enclosure contains a sturdy, lockable, hinged door for access to the termination compartment by qualified personnel as described in NFPA 70E and the National Electrical Code. Feeder conductor entry is provided in the bottom of the enclosure for the line side (generator). A hinged bottom plate is provided on the line side for access to line terminations. The permanent load connections (feeding to the facility overcurrent device) exit the enclosure from the bottom.

#### Terminations

All roll-up generator termination boxes contain a termination/lug landing for three phases and neutral plus ground. Line termination options include mechanical lugs, one-hole and two-hole compression lugs, one-hole and two-hole compression lug provisions, and quick disconnect.

Lug provisions are provided with bolt configurations as described in the catalog data on the following pages. Where lug provisions are ordered, lugs are supplied by others.

#### Standards and Certifications

- UL 1773 listed—termination boxes
- 600 Vac maximum
- Amperage ratings: 800, 1200, 1600, 2000 and 2500
- Assembly short-circuit rating: 25,000A rms symmetrical
- Marked "Suitable for use on the line side of service equipment" per UL 1773



**Technical Data and Specifications**

Approximate Dimensions in Inches (mm)

**Roll-Up Generator Termination Box with Line and Load Mechanical Box Lugs** ①

Ampere Rating	Dimensions Height	Width	Depth	Mechanical Box Lugs Line Termination Number, Range and Type	Mechanical Box Lugs Load Termination Number, Range and Type	Catalog Number
800	78.00 (1981.2)	36.00 (914.4)	24.00 (609.6)	(3) 4/0–500 kcmil Al/Cu	(3) 4/0–500 kcmil Al/Cu	GTB08MAMA
				(3) 4/0–500 kcmil Al/Cu	(2) 3/0–750 kcmil Al/Cu	GTB08MAMB
				(2) 3/0–750 kcmil Al/Cu	(3) 4/0–500 kcmil Al/Cu	GTB08MBMA
				(2) 3/0–750 kcmil Al/Cu	(2) 3/0–750 kcmil Al/Cu	GTB08MBMB
1200	78.00 (1981.2)	36.00 (914.4)	24.00 (609.6)	(4) 4/0–500 kcmil Al/Cu	(4) 4/0–500 kcmil Al/Cu	GTB12MCMC
				(4) 4/0–500 kcmil Al/Cu	(3) 3/0–750 kcmil Al/Cu	GTB12MCMD
				(3) 3/0–750 kcmil Al/Cu	(4) 4/0–500 kcmil Al/Cu	GTB12MDMC
				(3) 3/0–750 kcmil Al/Cu	(3) 3/0–750 kcmil Al/Cu	GTB12MDMD
1600	78.00 (1981.2)	36.00 (914.4)	24.00 (609.6)	(5) 4/0–500 kcmil Al/Cu	(5) 4/0–500 kcmil Al/Cu	GTB16MEME
				(5) 4/0–500 kcmil Al/Cu	(4) 3/0–750 kcmil Al/Cu	GTB16MEMF
				(4) 3/0–750 kcmil Al/Cu	(5) 4/0–500 kcmil Al/Cu	GTB16MFME
				(4) 3/0–750 kcmil Al/Cu	(4) 3/0–750 kcmil Al/Cu	GTB16MFMF
2000	78.00 (1981.2)	36.00 (914.4)	24.00 (609.6)	(6) 4/0–500 kcmil Al/Cu	(6) 4/0–500 kcmil Al/Cu	GTB20MGMG
				(6) 4/0–500 kcmil Al/Cu	(5) 3/0–750 kcmil Al/Cu	GTB20MGMH
				(5) 3/0–750 kcmil Al/Cu	(6) 4/0–500 kcmil Al/Cu	GTB20MHMG
				(5) 3/0–750 kcmil Al/Cu	(5) 3/0–750 kcmil Al/Cu	GTB20MHMH
2500	78.00 (1981.2)	36.00 (914.4)	24.00 (609.6)	(8) 4/0–500 kcmil Al/Cu	(8) 4/0–500 kcmil Al/Cu	GTB25MJMJ
				(8) 4/0–500 kcmil Al/Cu	(7) 3/0–750 kcmil Al/Cu	GTB25MJMK
				(7) 3/0–750 kcmil Al/Cu	(8) 4/0–500 kcmil Al/Cu	GTB25MKMJ
				(7) 3/0–750 kcmil Al/Cu	(7) 3/0–750 kcmil Al/Cu	GTB25MJMJ

4

**Roll-Up Generator Termination Box with Line Mechanical Box Lugs; Load Single-Hole Compression Lugs** ①②

Ampere Rating	Dimensions Height	Width	Depth	Mechanical Box Lugs Line Termination Number, Range and Type	Single-Hole Compression Load Termination Number, Range and Type	Catalog Number
800	78.00 (1981.2)	36.00 (914.4)	24.00 (609.6)	(3) 4/0–500 kcmil Al/Cu	(3) 4/0–500 kcmil Al/Cu	GTB08MACA
				(3) 4/0–500 kcmil Al/Cu	(2) 3/0–750 kcmil Al/Cu	GTB08MACB
				(2) 3/0–750 kcmil Al/Cu	(3) 4/0–500 kcmil Al/Cu	GTB08MBCA
				(2) 3/0–750 kcmil Al/Cu	(2) 3/0–750 kcmil Al/Cu	GTB08MBCB
1200	78.00 (1981.2)	36.00 (914.4)	24.00 (609.6)	(4) 4/0–500 kcmil Al/Cu	(4) 4/0–500 kcmil Al/Cu	GTB12MCCC
				(4) 4/0–500 kcmil Al/Cu	(3) 3/0–750 kcmil Al/Cu	GTB12MCCD
				(3) 3/0–750 kcmil Al/Cu	(4) 4/0–500 kcmil Al/Cu	GTB12MDCC
				(3) 3/0–750 kcmil Al/Cu	(3) 3/0–750 kcmil Al/Cu	GTB12MDCD
1600	78.00 (1981.2)	36.00 (914.4)	24.00 (609.6)	(5) 4/0–500 kcmil Al/Cu	(5) 4/0–500 kcmil Al/Cu	GTB16MECE
				(5) 4/0–500 kcmil Al/Cu	(4) 3/0–750 kcmil Al/Cu	GTB16MECF
				(4) 3/0–750 kcmil Al/Cu	(5) 4/0–500 kcmil Al/Cu	GTB16MFCE
				(4) 3/0–750 kcmil Al/Cu	(4) 3/0–750 kcmil Al/Cu	GTB16MFCF
2000	78.00 (1981.2)	36.00 (914.4)	24.00 (609.6)	(6) 4/0–500 kcmil Al/Cu	(6) 4/0–500 kcmil Al/Cu	GTB20MGCG
				(6) 4/0–500 kcmil Al/Cu	(5) 3/0–750 kcmil Al/Cu	GTB20MGCH
				(5) 3/0–750 kcmil Al/Cu	(6) 4/0–500 kcmil Al/Cu	GTB20MHCG
				(5) 3/0–750 kcmil Al/Cu	(5) 3/0–750 kcmil Al/Cu	GTB20MHCH
2500	78.00 (1981.2)	36.00 (914.4)	24.00 (609.6)	(8) 4/0–500 kcmil Al/Cu	(8) 4/0–500 kcmil Al/Cu	GTB25MJCJ
				(8) 4/0–500 kcmil Al/Cu	(7) 3/0–750 kcmil Al/Cu	GTB25MJCK
				(7) 3/0–750 kcmil Al/Cu	(8) 4/0–500 kcmil Al/Cu	GTB25MKCJ
				(7) 3/0–750 kcmil Al/Cu	(7) 3/0–750 kcmil Al/Cu	GTB25MJCJ

**Notes**

① Line side mechanical lugs are factory selected and installed.

② Load side Anderson, single-hole compression lugs are factory selected and installed.



# 4.6

## Switchboards

### Roll-Up Generator Termination Box

Approximate Dimensions in Inches (mm)

#### Roll-Up Generator Termination Box with Line Mechanical Box Lugs; Load Two-Hole Compression Lugs <sup>①②</sup>

Ampere Rating	Dimensions			Mechanical Box Lugs Line Termination Number, Range and Type	Two-Hole Compression Load Termination Cu Only Wire Size	Catalog Number
	Height	Width	Depth			
800	78.00 (1981.2)	45.00 (1143.0)	24.00 (609.6)	(3) 4/0–500 kcmil Al/Cu	(3) 350 kcmil Cu only	<b>GTB08MACL</b>
				(3) 4/0–500 kcmil Al/Cu	(3) 400 kcmil Cu only	<b>GTB08MBCM</b>
				(2) 3/0–750 kcmil Al/Cu	(3) 350 kcmil Cu only	<b>GTB08MBCL</b>
				(2) 3/0–750 kcmil Al/Cu	(3) 400 kcmil Cu only	<b>GTB08MACL</b>
1200	78.00 (1981.2)	45.00 (1143.0)	24.00 (609.6)	(4) 4/0–500 kcmil Al/Cu	(4) 500 kcmil Cu only	<b>GTB12MCCN</b>
				(4) 4/0–500 kcmil Al/Cu	(3) 600 kcmil Cu only	<b>GTB12MCCP</b>
				(4) 4/0–500 kcmil Al/Cu	(3) 750 kcmil Cu only	<b>GTB12MCCQ</b>
				(3) 3/0–750 kcmil Al/Cu	(4) 500 kcmil Cu only	<b>GTB12MDCN</b>
				(3) 3/0–750 kcmil Al/Cu	(3) 600 kcmil Cu only	<b>GTB12MDCP</b>
				(3) 3/0–750 kcmil Al/Cu	(3) 750 kcmil Cu only	<b>GTB12MDCQ</b>
				1600	78.00 (1981.2)	45.00 (1143.0)
(5) 4/0–500 kcmil Al/Cu	(4) 600 kcmil Cu only	<b>GTB16MECS</b>				
(5) 4/0–500 kcmil Al/Cu	(4) 750 kcmil Cu only	<b>GTB16MECT</b>				
(4) 3/0–750 kcmil Al/Cu	(5) 500 kcmil Cu only	<b>GTB16MFCR</b>				
(4) 3/0–750 kcmil Al/Cu	(4) 600 kcmil Cu only	<b>GTB16MFCS</b>				
(4) 3/0–750 kcmil Al/Cu	(4) 750 kcmil Cu only	<b>GTB16MFCT</b>				
2000	78.00 (1981.2)	45.00 (1143.0)	24.00 (609.6)	(6) 4/0–500 kcmil Al/Cu	(6) 500 kcmil Cu only	<b>GTB20MGCU</b>
				(6) 4/0–500 kcmil Al/Cu	(5) 600 kcmil Cu only	<b>GTB20MGCV</b>
				(6) 4/0–500 kcmil Al/Cu	(5) 750 kcmil Cu only	<b>GTB20MGCW</b>
				(5) 3/0–750 kcmil Al/Cu	(6) 500 kcmil Cu only	<b>GTB20MHCU</b>
				(5) 3/0–750 kcmil Al/Cu	(5) 600 kcmil Cu only	<b>GTB20MHCV</b>
				(5) 3/0–750 kcmil Al/Cu	(5) 750 kcmil Cu only	<b>GTB20MHCW</b>
2500	78.00 (1981.2)	45.00 (1143.0)	24.00 (609.6)	(8) 4/0–500 kcmil Al/Cu	(7) 500 kcmil Cu only	<b>GTB25MJCX</b>
				(8) 4/0–500 kcmil Al/Cu	(6) 600 kcmil Cu only	<b>GTB25MJCY</b>
				(8) 4/0–500 kcmil Al/Cu	(6) 750 kcmil Cu only	<b>GTB25MJCZ</b>
				(7) 3/0–750 kcmil Al/Cu	(7) 500 kcmil Cu only	<b>GTB25MKCX</b>
				(7) 3/0–750 kcmil Al/Cu	(6) 600 kcmil Cu only	<b>GTB25MKCY</b>
				(7) 3/0–750 kcmil Al/Cu	(6) 750 kcmil Cu only	<b>GTB25MKCZ</b>

#### Notes

- ① Line side mechanical lugs are factory selected and installed.
- ② Load side factory installed Burndy, two-hole, short barrel compression lugs suitable for copper wire only requires a 45-inch (1143.0 mm) wide enclosure.

## Roll-Up Generator Termination Box

Approximate Dimensions in Inches (mm)

**Roll-Up Generator Termination Box with Line Mechanical Box Lugs; Load Provisions Only, Single-Hole Compression Lugs** ①②

Ampere Rating	Dimensions			Mechanical Box Lugs Line Termination Number, Range and Type	Single-Hole Compression Load Provisions Only Number and Range	Catalog Number
	Height	Width	Depth			
800	78.00 (1981.2)	36.00 (914.4)	24.00 (609.6)	(3) 4/0–500 kcmil Al/Cu	(3) Provisions per phase	GTB08MAP1
				(2) 3/0–750 kcmil Al/Cu	(3) Provisions per phase	GTB08MBP1
1200	78.00 (1981.2)	36.00 (914.4)	24.00 (609.6)	(4) 4/0–500 kcmil Al/Cu	(4) Provisions per phase	GTB12MCP2
				(3) 3/0–750 kcmil Al/Cu	(4) Provisions per phase	GTB12MDP2
1600	78.00 (1981.2)	36.00 (914.4)	24.00 (609.6)	(5) 4/0–500 kcmil Al/Cu	(5) Provisions per phase	GTB16MEP3
				(4) 3/0–750 kcmil Al/Cu	(5) Provisions per phase	GTB16MFP3
2000	78.00 (1981.2)	36.00 (914.4)	24.00 (609.6)	(6) 4/0–500 kcmil Al/Cu	(6) Provisions per phase	GTB20MGP4
				(5) 3/0–750 kcmil Al/Cu	(6) Provisions per phase	GTB20MHP4
2500	78.00 (1981.2)	36.00 (914.4)	24.00 (609.6)	(8) 4/0–500 kcmil Al/Cu	(8) Provisions per phase	GTB25MJP5
				(7) 3/0–750 kcmil Al/Cu	(8) Provisions per phase	GTB25MKP5

4

**Roll-Up Generator Termination Box with Line Mechanical Box Lugs; Load Provisions Only, Two-Hole Compression Lugs** ①③④

Ampere Rating	Dimensions			Mechanical Box Lugs Line Termination Number, Range and Type	Two-Hole Compression Load Provisions Only Number and Range	Catalog Number
	Height	Width	Depth			
800	78.00 (1981.2)	45.00 (1143.0)	24.00 (609.6)	(3) 4/0–500 kcmil Al/Cu	(3) Provisions per phase	GTB08MAPA
				(2) 3/0–750 kcmil Al/Cu	(3) Provisions per phase	GTB08MBPA
1200	78.00 (1981.2)	45.00 (1143.0)	24.00 (609.6)	(4) 4/0–500 kcmil Al/Cu	(4) Provisions per phase	GTB12MCPB
				(3) 3/0–750 kcmil Al/Cu	(4) Provisions per phase	GTB12MDPB
1600	78.00 (1981.2)	45.00 (1143.0)	24.00 (609.6)	(5) 4/0–500 kcmil Al/Cu	(5) Provisions per phase	GTB16MEPC
				(4) 3/0–750 kcmil Al/Cu	(5) Provisions per phase	GTB16MFPC
2000	78.00 (1981.2)	45.00 (1143.0)	24.00 (609.6)	(6) 4/0–500 kcmil Al/Cu	(6) Provisions per phase	GTB20MGPD
				(5) 3/0–750 kcmil Al/Cu	(6) Provisions per phase	GTB20MHPD
2500	78.00 (1981.2)	45.00 (1143.0)	24.00 (609.6)	(8) 4/0–500 kcmil Al/Cu	(8) Provisions per phase	GTB25MJPE
				(7) 3/0–750 kcmil Al/Cu	(8) Provisions per phase	GTB25MKPE

**Notes**

- ① Line side mechanical lugs are factory selected and installed.
- ② Load side factory installed 3/8-inch bolt provisions for single-hole compression lugs (lugs furnished by others).
- ③ Load side factory installed 1/2-inch bolt provisions on 1-3/4-inch hole centers for two-hole compression lugs (lugs furnished by others).
- ④ Requires 45-inch (1143.0 mm) wide enclosure.

# 4.6

## Switchboards

### Roll-Up Generator Termination Box

Approximate Dimensions in Inches (mm)

#### Roll-Up Generator Termination Box with Line Single-Hole Compression Lugs and Load Mechanical Box Lugs <sup>①②</sup>

Ampere Rating	Dimensions Height	Width	Depth	Single-Hole Compression Line Termination Number, Range and Type	Mechanical Box Lugs Load Termination Number, Range and Type	Catalog Number
800	78.00 (1981.2)	36.00 (914.4)	24.00 (609.6)	(3) 4/0–500 kcmil Al/Cu	(3) 4/0–500 kcmil Al/Cu	<b>GTB08CAMA</b>
				(3) 4/0–500 kcmil Al/Cu	(2) 3/0–750 kcmil Al/Cu	<b>GTB08CAMB</b>
				(2) 3/0–750 kcmil Al/Cu	(3) 4/0–500 kcmil Al/Cu	<b>GTB08CBMA</b>
				(2) 3/0–750 kcmil Al/Cu	(2) 3/0–750 kcmil Al/Cu	<b>GTB08CBMB</b>
1200	78.00 (1981.2)	36.00 (914.4)	24.00 (609.6)	(4) 4/0–500 kcmil Al/Cu	(4) 4/0–500 kcmil Al/Cu	<b>GTB12CCMC</b>
				(4) 4/0–500 kcmil Al/Cu	(3) 3/0–750 kcmil Al/Cu	<b>GTB12CCMD</b>
				(3) 3/0–750 kcmil Al/Cu	(4) 4/0–500 kcmil Al/Cu	<b>GTB12CDMC</b>
				(3) 3/0–750 kcmil Al/Cu	(3) 3/0–750 kcmil Al/Cu	<b>GTB12CDMD</b>
1600	78.00 (1981.2)	36.00 (914.4)	24.00 (609.6)	(5) 4/0–500 kcmil Al/Cu	(5) 4/0–500 kcmil Al/Cu	<b>GTB16CEME</b>
				(5) 4/0–500 kcmil Al/Cu	(4) 3/0–750 kcmil Al/Cu	<b>GTB16CEMF</b>
				(4) 3/0–750 kcmil Al/Cu	(5) 4/0–500 kcmil Al/Cu	<b>GTB16CFME</b>
				(4) 3/0–750 kcmil Al/Cu	(4) 3/0–750 kcmil Al/Cu	<b>GTB16CFMF</b>
2000	78.00 (1981.2)	36.00 (914.4)	24.00 (609.6)	(6) 4/0–500 kcmil Al/Cu	(6) 4/0–500 kcmil Al/Cu	<b>GTB20CGMG</b>
				(6) 4/0–500 kcmil Al/Cu	(5) 3/0–750 kcmil Al/Cu	<b>GTB20CGMH</b>
				(5) 3/0–750 kcmil Al/Cu	(6) 4/0–500 kcmil Al/Cu	<b>GTB20CHMG</b>
				(5) 3/0–750 kcmil Al/Cu	(5) 3/0–750 kcmil Al/Cu	<b>GTB20CHMH</b>
2500	78.00 (1981.2)	36.00 (914.4)	24.00 (609.6)	(8) 4/0–500 kcmil Al/Cu	(8) 4/0–500 kcmil Al/Cu	<b>GTB25CJMJ</b>
				(8) 4/0–500 kcmil Al/Cu	(7) 3/0–750 kcmil Al/Cu	<b>GTB25CJMK</b>
				(7) 3/0–750 kcmil Al/Cu	(8) 4/0–500 kcmil Al/Cu	<b>GTB25CKMJ</b>
				(7) 3/0–750 kcmil Al/Cu	(7) 3/0–750 kcmil Al/Cu	<b>GTB25CJMK</b>

#### Roll-Up Generator Termination Box with Line and Load Single-Hole Compression Lugs <sup>③</sup>

Ampere Rating	Dimensions Height	Width	Depth	Single-Hole Compression Line Termination Number, Range and Type	Single-Hole Compression Load Termination Number, Range and Type	Catalog Number
800	78.00 (1981.2)	36.00 (914.4)	24.00 (609.6)	(3) 4/0–500 kcmil Al/Cu	(3) 4/0–500 kcmil Al/Cu	<b>GTB08CACA</b>
				(3) 4/0–500 kcmil Al/Cu	(2) 3/0–750 kcmil Al/Cu	<b>GTB08CACB</b>
				(2) 3/0–750 kcmil Al/Cu	(3) 4/0–500 kcmil Al/Cu	<b>GTB08CBCA</b>
				(2) 3/0–750 kcmil Al/Cu	(2) 3/0–750 kcmil Al/Cu	<b>GTB08CBCB</b>
1200	78.00 (1981.2)	36.00 (914.4)	24.00 (609.6)	(4) 4/0–500 kcmil Al/Cu	(4) 4/0–500 kcmil Al/Cu	<b>GTB12CCCC</b>
				(4) 4/0–500 kcmil Al/Cu	(3) 3/0–750 kcmil Al/Cu	<b>GTB12CCCD</b>
				(3) 3/0–750 kcmil Al/Cu	(4) 4/0–500 kcmil Al/Cu	<b>GTB12CDCC</b>
				(3) 3/0–750 kcmil Al/Cu	(3) 3/0–750 kcmil Al/Cu	<b>GTB12CDCD</b>
1600	78.00 (1981.2)	36.00 (914.4)	24.00 (609.6)	(5) 4/0–500 kcmil Al/Cu	(5) 4/0–500 kcmil Al/Cu	<b>GTB16CECE</b>
				(5) 4/0–500 kcmil Al/Cu	(4) 3/0–750 kcmil Al/Cu	<b>GTB16CECF</b>
				(4) 3/0–750 kcmil Al/Cu	(5) 4/0–500 kcmil Al/Cu	<b>GTB16CFCE</b>
				(4) 3/0–750 kcmil Al/Cu	(4) 3/0–750 kcmil Al/Cu	<b>GTB16CFCF</b>
2000	78.00 (1981.2)	36.00 (914.4)	24.00 (609.6)	(6) 4/0–500 kcmil Al/Cu	(6) 4/0–500 kcmil Al/Cu	<b>GTB20CGCG</b>
				(6) 4/0–500 kcmil Al/Cu	(5) 3/0–750 kcmil Al/Cu	<b>GTB20CGCH</b>
				(5) 3/0–750 kcmil Al/Cu	(6) 4/0–500 kcmil Al/Cu	<b>GTB20CHCG</b>
				(5) 3/0–750 kcmil Al/Cu	(5) 3/0–750 kcmil Al/Cu	<b>GTB20CHCH</b>
2500	78.00 (1981.2)	36.00 (914.4)	24.00 (609.6)	(8) 4/0–500 kcmil Al/Cu	(8) 4/0–500 kcmil Al/Cu	<b>GTB25CJCJ</b>
				(8) 4/0–500 kcmil Al/Cu	(7) 3/0–750 kcmil Al/Cu	<b>GTB25CJCK</b>
				(7) 3/0–750 kcmil Al/Cu	(8) 4/0–500 kcmil Al/Cu	<b>GTB25CKCJ</b>
				(7) 3/0–750 kcmil Al/Cu	(7) 3/0–750 kcmil Al/Cu	<b>GTB25CJCK</b>

#### Notes

- ① Line side Anderson, single-hole compression lugs are factory selected and installed.
- ② Load side mechanical lugs are factory selected and installed.
- ③ Line side and load Anderson, single-hole compression lugs are factory selected and installed.

## Roll-Up Generator Termination Box

Approximate Dimensions in Inches (mm)

Roll-Up Generator Termination Box with Line Single-Hole Compression Lugs; Load Two-Hole Compression Lugs <sup>①②③</sup>

Ampere Rating	Dimensions Height	Width	Depth	Single-Hole Compression Line Termination Number, Range and Type	Two-Hole Compression Load Termination Cu Only Wire Size	Catalog Number
800	78.00 (1981.2)	45.00 (1143.0)	24.00 (609.6)	(3) 4/0–500 kcmil Al/Cu	(3) 350 kcmil Cu only	GTB08CACL
				(3) 4/0–500 kcmil Al/Cu	(3) 400 kcmil Cu only	GTB08CACM
				(2) 3/0–750 kcmil Al/Cu	(3) 350 kcmil Cu only	GTB08CBCL
				(2) 3/0–750 kcmil Al/Cu	(3) 400 kcmil Cu only	GTB08CBCM
1200	78.00 (1981.2)	45.00 (1143.0)	24.00 (609.6)	(4) 4/0–500 kcmil Al/Cu	(4) 500 kcmil Cu only	GTB12CCCN
				(4) 4/0–500 kcmil Al/Cu	(3) 600 kcmil Cu only	GTB12CCCP
				(4) 4/0–500 kcmil Al/Cu	(3) 750 kcmil Cu only	GTB12CCCQ
				(3) 3/0–750 kcmil Al/Cu	(4) 500 kcmil Cu only	GTB12CDCN
				(3) 3/0–750 kcmil Al/Cu	(3) 600 kcmil Cu only	GTB12CDCP
				(3) 3/0–750 kcmil Al/Cu	(3) 750 kcmil Cu only	GTB12CDCQ
1600	78.00 (1981.2)	45.00 (1143.0)	24.00 (609.6)	(5) 4/0–500 kcmil Al/Cu	(5) 500 kcmil Cu only	GTB16CECR
				(5) 4/0–500 kcmil Al/Cu	(4) 600 kcmil Cu only	GTB16CECS
				(5) 4/0–500 kcmil Al/Cu	(4) 750 kcmil Cu only	GTB16CECT
				(4) 3/0–750 kcmil Al/Cu	(5) 500 kcmil Cu only	GTB16CFCR
				(4) 3/0–750 kcmil Al/Cu	(4) 600 kcmil Cu only	GTB16CFCS
				(4) 3/0–750 kcmil Al/Cu	(4) 750 kcmil Cu only	GTB16CFCT
2000	78.00 (1981.2)	45.00 (1143.0)	24.00 (609.6)	(6) 4/0–500 kcmil Al/Cu	(6) 500 kcmil Cu only	GTB20CGCU
				(6) 4/0–500 kcmil Al/Cu	(5) 600 kcmil Cu only	GTB20CGCV
				(6) 4/0–500 kcmil Al/Cu	(5) 750 kcmil Cu only	GTB20CGCW
				(5) 3/0–750 kcmil Al/Cu	(6) 500 kcmil Cu only	GTB20CHCU
				(5) 3/0–750 kcmil Al/Cu	(5) 600 kcmil Cu only	GTB20CHCV
				(5) 3/0–750 kcmil Al/Cu	(5) 750 kcmil Cu only	GTB20CHCW
2500	78.00 (1981.2)	45.00 (1143.0)	24.00 (609.6)	(8) 4/0–500 kcmil Al/Cu	(7) 500 kcmil Cu only	GTB25CJCX
				(8) 4/0–500 kcmil Al/Cu	(6) 600 kcmil Cu only	GTB25CJCY
				(8) 4/0–500 kcmil Al/Cu	(6) 750 kcmil Cu only	GTB25CJCZ
				(7) 3/0–750 kcmil Al/Cu	(7) 500 kcmil Cu only	GTB25CKCX
				(7) 3/0–750 kcmil Al/Cu	(6) 600 kcmil Cu only	GTB25CKCY
				(7) 3/0–750 kcmil Al/Cu	(6) 750 kcmil Cu only	GTB25CKCZ

Roll-Up Generator Termination Box with Line Single-Hole Compression Lugs; Load Provisions Only, Single-Hole Compression Lugs <sup>①④</sup>

Ampere Rating	Dimensions Height	Width	Depth	Single-Hole Compression Line Termination Number, Range and Type	Single-Hole Compression Load Provisions Only Number and Range	Catalog Number
800	78.00 (1981.2)	36.00 (914.4)	24.00 (609.6)	(3) 4/0–500 kcmil Al/Cu	(3) Provisions per phase	GTB08CAP1
				(2) 3/0–750 kcmil Al/Cu	(3) Provisions per phase	GTB08CBP1
1200	78.00 (1981.2)	36.00 (914.4)	24.00 (609.6)	(4) 4/0–500 kcmil Al/Cu	(4) Provisions per phase	GTB12CCP2
				(3) 3/0–750 kcmil Al/Cu	(4) Provisions per phase	GTB12CDP2
1600	78.00 (1981.2)	36.00 (914.4)	24.00 (609.6)	(5) 4/0–500 kcmil Al/Cu	(5) Provisions per phase	GTB16CEP3
				(4) 3/0–750 kcmil Al/Cu	(5) Provisions per phase	GTB16CFP3
2000	78.00 (1981.2)	36.00 (914.4)	24.00 (609.6)	(6) 4/0–500 kcmil Al/Cu	(6) Provisions per phase	GTB20CGP4
				(5) 3/0–750 kcmil Al/Cu	(6) Provisions per phase	GTB20CHP4
2500	78.00 (1981.2)	36.00 (914.4)	24.00 (609.6)	(8) 4/0–500 kcmil Al/Cu	(8) Provisions per phase	GTB25CJP5
				(7) 3/0–750 kcmil Al/Cu	(8) Provisions per phase	GTB25CKP5

**Notes**

- ① Line side Anderson, single-hole compression lugs are factory selected and installed.
- ② Load side factory installed Burndy, two-hole, short barrel compression lugs suitable for copper wire only.
- ③ Requires 45-inch (1143.0 mm) wide enclosure.
- ④ Load side factory installed 3/8-inch bolt provisions for single-hole compression lugs (lugs furnished by others).

# 4.6

## Switchboards

### Roll-Up Generator Termination Box

Approximate Dimensions in Inches (mm)

#### Roll-Up Generator Termination Box with Single-Hole Compression Lugs; Load Provisions Only, Two-Hole Compression Lugs) ①②③

Ampere Rating	Dimensions			Single-Hole Compression Line Termination Number, Range and Type	Two-Hole Compression Load Provisions Only Number and Range	Catalog Number
	Height	Width	Depth			
800	78.00 (1981.2)	45.00 (1143.0)	24.00 (609.6)	(3) 4/0–500 kcmil Al/Cu	(3) Provisions per phase	GTB08CAPA
				(2) 3/0–750 kcmil Al/Cu	(3) Provisions per phase	GTB08CBPA
1200	78.00 (1981.2)	45.00 (1143.0)	24.00 (609.6)	(4) 4/0–500 kcmil Al/Cu	(4) Provisions per phase	GTB12CCPB
				(3) 3/0–750 kcmil Al/Cu	(4) Provisions per phase	GTB12CDPB
1600	78.00 (1981.2)	45.00 (1143.0)	24.00 (609.6)	(5) 4/0–500 kcmil Al/Cu	(5) Provisions per phase	GTB16CEPC
				(4) 3/0–750 kcmil Al/Cu	(5) Provisions per phase	GTB16CGPC
2000	78.00 (1981.2)	45.00 (1143.0)	24.00 (609.6)	(6) 4/0–500 kcmil Al/Cu	(6) Provisions per phase	GTB20CGPD
				(5) 3/0–750 kcmil Al/Cu	(6) Provisions per phase	GTB20CHPD
2500	78.00 (1981.2)	45.00 (1143.0)	24.00 (609.6)	(8) 4/0–500 kcmil Al/Cu	(8) Provisions per phase	GTB25CJPE
				(7) 3/0–750 kcmil Al/Cu	(8) Provisions per phase	GTB25CKPE

#### Roll-Up Generator Termination Box with Line Two-Hole Compression Lugs and Load Mechanical Box Lugs ③④⑤

Ampere Rating	Dimensions			Two-Hole Compression Line Termination Cu Only Wire Size	Mechanical Box Lugs Load Termination Number, Range and Type	Catalog Number
	Height	Width	Depth			
800	78.00 (1981.2)	45.00 (1143.0)	24.00 (609.6)	(3) 350 kcmil Cu only	(3) 4/0–500 kcmil Al/Cu	GTB08CLMA
				(3) 350 kcmil Cu only	(2) 3/0–750 kcmil Al/Cu	GTB08CLMB
				(3) 400 kcmil Cu only	(3) 4/0–500 kcmil Al/Cu	GTB08CMMA
				(3) 400 kcmil Cu only	(2) 3/0–750 kcmil Al/Cu	GTB08CMMB
1200	78.00 (1981.2)	45.00 (1143.0)	24.00 (609.6)	(4) 500 kcmil Cu only	(4) 4/0–500 kcmil Al/Cu	GTB12CNMC
				(4) 500 kcmil Cu only	(3) 3/0–750 kcmil Al/Cu	GTB12CNMD
				(3) 600 kcmil Cu only	(4) 4/0–500 kcmil Al/Cu	GTB12CPMC
				(3) 600 kcmil Cu only	(3) 3/0–750 kcmil Al/Cu	GTB12CPMD
				(3) 750 kcmil Cu only	(4) 4/0–500 kcmil Al/Cu	GTB12CQMC
				(3) 750 kcmil Cu only	(3) 3/0–750 kcmil Al/Cu	GTB12CQMD
1600	78.00 (1981.2)	45.00 (1143.0)	24.00 (609.6)	(5) 500 kcmil Cu only	(5) 4/0–500 kcmil Al/Cu	GTB16CRME
				(5) 500 kcmil Cu only	(4) 3/0–750 kcmil Al/Cu	GTB16CRMF
				(4) 600 kcmil Cu only	(5) 4/0–500 kcmil Al/Cu	GTB16CSME
				(4) 600 kcmil Cu only	(4) 3/0–750 kcmil Al/Cu	GTB16CSMF
				(4) 750 kcmil Cu only	(5) 4/0–500 kcmil Al/Cu	GTB16CTME
				(4) 750 kcmil Cu only	(4) 3/0–750 kcmil Al/Cu	GTB16CTMF
2000	78.00 (1981.2)	45.00 (1143.0)	24.00 (609.6)	(6) 500 kcmil Cu only	(6) 4/0–500 kcmil Al/Cu	GTB20CUMG
				(6) 500 kcmil Cu only	(5) 3/0–750 kcmil Al/Cu	GTB20CUMH
				(5) 600 kcmil Cu only	(6) 4/0–500 kcmil Al/Cu	GTB20CVMG
				(5) 600 kcmil Cu only	(5) 3/0–750 kcmil Al/Cu	GTB20CVMH
				(5) 750 kcmil Cu only	(6) 4/0–500 kcmil Al/Cu	GTB20CWVG
2500	78.00 (1981.2)	45.00 (1143.0)	24.00 (609.6)	(7) 500 kcmil Cu only	(8) 4/0–500 kcmil Al/Cu	GTB25CXMJ
				(7) 500 kcmil Cu only	(7) 3/0–750 kcmil Al/Cu	GTB25CXMK
				(6) 600 kcmil Cu only	(8) 4/0–500 kcmil Al/Cu	GTB25CYMJ
				(6) 600 kcmil Cu only	(7) 3/0–750 kcmil Al/Cu	GTB25CYMK
				(6) 750 kcmil Cu only	(8) 4/0–500 kcmil Al/Cu	GTB25CZMJ
(6) 750 kcmil Cu only	(7) 3/0–750 kcmil Al/Cu	GTB25CZMK				

#### Notes

- ① Line side Anderson, single-hole compression lugs are factory selected and installed.
- ② Load side factory installed 1/2-inch bolt provisions on 1-3/4-inch hole centers for two-hole compression lugs (lugs furnished by others).
- ③ Requires 45-inch (1143.0 mm) wide enclosure.
- ④ Line side factory installed Burndy, two-hole, short barrel compression lugs suitable for copper wire only.
- ⑤ Load side mechanical lugs are factory selected and installed.

## Roll-Up Generator Termination Box

Approximate Dimensions in Inches (mm)

## Roll-Up Generator Termination Box with Line Two-Hole Compression Lugs and Load Single-Hole Compression Lugs

Ampere Rating	Dimensions			Two-Hole Compression Line Termination Cu Only Wire Size	Single-Hole Compression Load Termination Number, Range and Type	Catalog Number
	Height	Width	Depth			
800	78.00 (1981.2)	45.00 (1143.0)	24.00 (609.6)	(3) 350 kcmil Cu only	(3) 4/0–500 kcmil Al/Cu	GTB08CLCA
				(3) 350 kcmil Cu only	(2) 3/0–750 kcmil Al/Cu	GTB08CLCB
				(3) 400 kcmil Cu only	(3) 4/0–500 kcmil Al/Cu	GTB08CMCA
				(3) 400 kcmil Cu only	(2) 3/0–750 kcmil Al/Cu	GTB08CMCB
1200	78.00 (1981.2)	45.00 (1143.0)	24.00 (609.6)	(4) 500 kcmil Cu only	(4) 4/0–500 kcmil Al/Cu	GTB12CNCC
				(4) 500 kcmil Cu only	(3) 3/0–750 kcmil Al/Cu	GTB12CNCD
				(3) 600 kcmil Cu only	(4) 4/0–500 kcmil Al/Cu	GTB12CPCC
				(3) 600 kcmil Cu only	(3) 3/0–750 kcmil Al/Cu	GTB12CPCD
				(3) 750 kcmil Cu only	(4) 4/0–500 kcmil Al/Cu	GTB12CQCC
				(3) 750 kcmil Cu only	(3) 3/0–750 kcmil Al/Cu	GTB12CQCD
1600	78.00 (1981.2)	45.00 (1143.0)	24.00 (609.6)	(5) 500 kcmil Cu only	(5) 4/0–500 kcmil Al/Cu	GTB16CRCE
				(5) 500 kcmil Cu only	(4) 3/0–750 kcmil Al/Cu	GTB16CRCF
				(4) 600 kcmil Cu only	(5) 4/0–500 kcmil Al/Cu	GTB16CSCE
				(4) 600 kcmil Cu only	(4) 3/0–750 kcmil Al/Cu	GTB16CSCF
				(4) 750 kcmil Cu only	(5) 4/0–500 kcmil Al/Cu	GTB16CTCE
				(4) 750 kcmil Cu only	(4) 3/0–750 kcmil Al/Cu	GTB16CTCF
2000	78.00 (1981.2)	45.00 (1143.0)	24.00 (609.6)	(6) 500 kcmil Cu only	(6) 4/0–500 kcmil Al/Cu	GTB20CUCG
				(6) 500 kcmil Cu only	(5) 3/0–750 kcmil Al/Cu	GTB20CUCH
				(5) 600 kcmil Cu only	(6) 4/0–500 kcmil Al/Cu	GTB20CVCG
				(5) 600 kcmil Cu only	(5) 3/0–750 kcmil Al/Cu	GTB20CVCH
				(5) 750 kcmil Cu only	(6) 4/0–500 kcmil Al/Cu	GTB20CWCG
				(5) 750 kcmil Cu only	(5) 3/0–750 kcmil Al/Cu	GTB20CWCH
2500	78.00 (1981.2)	45.00 (1143.0)	24.00 (609.6)	(7) 500 kcmil Cu only	(8) 4/0–500 kcmil Al/Cu	GTB25CX CJ
				(7) 500 kcmil Cu only	(7) 3/0–750 kcmil Al/Cu	GTB25CXCK
				(6) 600 kcmil Cu only	(8) 4/0–500 kcmil Al/Cu	GTB25CYCJ
				(6) 600 kcmil Cu only	(7) 3/0–750 kcmil Al/Cu	GTB25CYCK
				(6) 750 kcmil Cu only	(8) 4/0–500 kcmil Al/Cu	GTB25CZCJ
				(6) 750 kcmil Cu only	(7) 3/0–750 kcmil Al/Cu	GTB25CZCK

**Notes**

Line side factory installed Burndy, two-hole, short barrel compression lugs suitable for copper wire only.

Load side Anderson, single-hole compression lugs are factory selected and installed.

Requires 45-inch (1143.0 mm) wide enclosure.

# 4.6

## Switchboards

### Roll-Up Generator Termination Box

Approximate Dimensions in Inches (mm)

#### Roll-Up Generator Termination Box with Line Two-Hole Compression Lugs; Load Two-Hole Compression Lugs

Ampere Rating	Dimensions			Two-Hole Compression Line Termination Cu Only Wire Size	Two-Hole Compression Load Termination Cu Only Wire Size	Catalog Number
	Height	Width	Depth			
800	78.00 (1981.2)	45.00 (1143.0)	24.00 (609.6)	(3) 350 kcmil Cu only	(3) 350 kcmil Cu only	<b>GTB08CLCL</b>
				(3) 350 kcmil Cu only	(3) 400 kcmil Cu only	<b>GTB08CLCM</b>
				(3) 400 kcmil Cu only	(3) 350 kcmil Cu only	<b>GTB08CMCL</b>
				(3) 400 kcmil Cu only	(3) 400 kcmil Cu only	<b>GTB08CMCM</b>
1200	78.00 (1981.2)	45.00 (1143.0)	24.00 (609.6)	(4) 500 kcmil Cu only	(4) 500 kcmil Cu only	<b>GTB12CNCN</b>
				(4) 500 kcmil Cu only	(3) 600 kcmil Cu only	<b>GTB12CNCP</b>
				(4) 500 kcmil Cu only	(3) 750 kcmil Cu only	<b>GTB12CNCQ</b>
				(3) 600 kcmil Cu only	(4) 500 kcmil Cu only	<b>GTB12PCPN</b>
				(3) 600 kcmil Cu only	(3) 600 kcmil Cu only	<b>GTB12PCPP</b>
				(3) 600 kcmil Cu only	(3) 750 kcmil Cu only	<b>GTB12PCPQ</b>
				(3) 750 kcmil Cu only	(4) 500 kcmil Cu only	<b>GTB12CQCN</b>
				(3) 750 kcmil Cu only	(3) 600 kcmil Cu only	<b>GTB12CQCP</b>
				(3) 750 kcmil Cu only	(3) 750 kcmil Cu only	<b>GTB12CQCQ</b>
				1600	78.00 (1981.2)	45.00 (1143.0)
(5) 500 kcmil Cu only	(4) 600 kcmil Cu only	<b>GTB16CRCS</b>				
(5) 500 kcmil Cu only	(4) 750 kcmil Cu only	<b>GTB16CRCT</b>				
(4) 600 kcmil Cu only	(5) 500 kcmil Cu only	<b>GTB16CSCR</b>				
(4) 600 kcmil Cu only	(4) 600 kcmil Cu only	<b>GTB16CSCS</b>				
(4) 600 kcmil Cu only	(4) 750 kcmil Cu only	<b>GTB16CSCT</b>				
(4) 750 kcmil Cu only	(5) 500 kcmil Cu only	<b>GTB16CTCR</b>				
(4) 750 kcmil Cu only	(4) 600 kcmil Cu only	<b>GTB16CTCS</b>				
(4) 750 kcmil Cu only	(4) 750 kcmil Cu only	<b>GTB16CTCT</b>				
2000	78.00 (1981.2)	45.00 (1143.0)	24.00 (609.6)	(6) 500 kcmil Cu only	(6) 500 kcmil Cu only	<b>GTB20UCU</b>
				(6) 500 kcmil Cu only	(5) 600 kcmil Cu only	<b>GTB20UCUV</b>
				(6) 500 kcmil Cu only	(5) 750 kcmil Cu only	<b>GTB20UCUW</b>
				(5) 600 kcmil Cu only	(6) 500 kcmil Cu only	<b>GTB20VCU</b>
				(5) 600 kcmil Cu only	(5) 600 kcmil Cu only	<b>GTB20VCUV</b>
				(5) 600 kcmil Cu only	(5) 750 kcmil Cu only	<b>GTB20VCUW</b>
				(5) 750 kcmil Cu only	(6) 500 kcmil Cu only	<b>GTB20WCU</b>
				(5) 750 kcmil Cu only	(5) 600 kcmil Cu only	<b>GTB20WCUV</b>
				(5) 750 kcmil Cu only	(5) 750 kcmil Cu only	<b>GTB20WCUW</b>
2500	78.00 (1981.2)	45.00 (1143.0)	24.00 (609.6)	(7) 500 kcmil Cu only	(7) 500 kcmil Cu only	<b>GTB25CXCX</b>
				(7) 500 kcmil Cu only	(6) 600 kcmil Cu only	<b>GTB25CXCY</b>
				(7) 500 kcmil Cu only	(6) 750 kcmil Cu only	<b>GTB25CX CZ</b>
				(6) 600 kcmil Cu only	(7) 500 kcmil Cu only	<b>GTB25CYCX</b>
				(6) 600 kcmil Cu only	(6) 600 kcmil Cu only	<b>GTB25CYCY</b>
				(6) 600 kcmil Cu only	(6) 750 kcmil Cu only	<b>GTB25CY CZ</b>
				(6) 750 kcmil Cu only	(7) 500 kcmil Cu only	<b>GTB25CZCX</b>
				(6) 750 kcmil Cu only	(6) 600 kcmil Cu only	<b>GTB25CZCY</b>
				(6) 750 kcmil Cu only	(6) 750 kcmil Cu only	<b>GTB25CZ CZ</b>

#### Notes

Line and load side factory installed Burndy, two-hole, short barrel compression lugs suitable for copper wire only. Requires 45-inch (1143.0 mm) wide enclosure.

## Roll-Up Generator Termination Box

Approximate Dimensions in Inches (mm)

**Roll-Up Generator Termination Box with Line Two-Hole Compression Lugs; Load Provisions Only, Single-Hole Compression Lugs** <sup>①②③</sup>

Ampere Rating	Dimensions Height	Width	Depth	Two-Hole Compression Line Termination Cu Only Wire Size	Single-Hole Compression Load Provisions Only Number and Range	Catalog Number
800	78.00 (1981.2)	45.00 (1143.0)	24.00 (609.6)	(3) 350 kcmil Cu only	(3) Provisions per phase	GTB08CLP1
				(3) 400 kcmil Cu only	(3) Provisions per phase	GTB08CMP1
1200	78.00 (1981.2)	45.00 (1143.0)	24.00 (609.6)	(4) 500 kcmil Cu only	(4) Provisions per phase	GTB12CNP2
				(3) 600 kcmil Cu only	(4) Provisions per phase	GTB12CPP2
				(3) 750 kcmil Cu only	(4) Provisions per phase	GTB12CQP2
2000	78.00 (1981.2)	45.00 (1143.0)	24.00 (609.6)	(6) 500 kcmil Cu only	(6) Provisions per phase	GTB20CUP4
				(5) 600 kcmil Cu only	(6) Provisions per phase	GTB20CVP4
				(5) 750 kcmil Cu only	(6) Provisions per phase	GTB20CWP4
2500	78.00 (1981.2)	45.00 (1143.0)	24.00 (609.6)	(7) 500 kcmil Cu only	(8) Provisions per phase	GTB25CXP5
				(6) 600 kcmil Cu only	(8) Provisions per phase	GTB25CYP6
				(6) 750 kcmil Cu only	(8) Provisions per phase	GTB25CZP6

4

**Roll-Up Generator Termination Box with Two-Hole Compression Lugs; Load Provisions Only, Two-Hole Compression Lugs** <sup>④</sup>

Ampere Rating	Dimensions Height	Width	Depth	Two-Hole Compression Line Termination Cu Only Wire Size	Two-Hole Compression Load Provisions Only Number and Range	Catalog Number
800	78.00 (1981.2)	45.00 (1143.0)	24.00 (609.6)	(3) 350 kcmil Cu only	(3) Provisions per phase	GTB08CLPA
				(3) 400 kcmil Cu only	(3) Provisions per phase	GTB08CMPA
1200	78.00 (1981.2)	45.00 (1143.0)	24.00 (609.6)	(4) 500 kcmil Cu only	(4) Provisions per phase	GTB12CNPB
				(3) 600 kcmil Cu only	(4) Provisions per phase	GTB12CPPB
				(3) 750 kcmil Cu only	(4) Provisions per phase	GTB12CQPB
1600	78.00 (1981.2)	45.00 (1143.0)	24.00 (609.6)	(5) 500 kcmil Cu only	(5) Provisions per phase	GTB16CRPC
				(4) 600 kcmil Cu only	(5) Provisions per phase	GTB16CSPC
				(4) 750 kcmil Cu only	(5) Provisions per phase	GTB16CTPC
2000	78.00 (1981.2)	45.00 (1143.0)	24.00 (609.6)	(6) 500 kcmil Cu only	(6) Provisions per phase	GTB20CUPD
				(5) 600 kcmil Cu only	(6) Provisions per phase	GTB20CVPD
				(5) 750 kcmil Cu only	(6) Provisions per phase	GTB20CWPD
2500	78.00 (1981.2)	45.00 (1143.0)	24.00 (609.6)	(7) 500 kcmil Cu only	(8) Provisions per phase	GTB25CXPE
				(6) 600 kcmil Cu only	(8) Provisions per phase	GTB25CYPE
				(6) 750 kcmil Cu only	(8) Provisions per phase	GTB25CZPE

**Notes**

- ① Line side factory installed Burndy, two-hole, short barrel compression lugs suitable for copper wire only.
- ② Load side factory installed 3/8-inch bolt provisions for single-hole compression lugs (lugs furnished by others).
- ③ Requires 45-inch (1143.0 mm) wide enclosure.
- ④ Load side factory installed 1/2-inch bolt provisions on 1-3/4-inch hole centers for two-hole compression lugs (lugs furnished by others).



# 4.6

## Switchboards

### Roll-Up Generator Termination Box

Approximate Dimensions in Inches (mm)

#### Roll-Up Generator Termination Box with Line Single-Hole Compression Lug Provisions; Load Mechanical Box Lugs <sup>①②</sup>

Ampere Rating	Dimensions			Single-Hole Compression Line Provisions Only Number and Range	Mechanical Box Lugs Load Termination Number, Range and Type	Catalog Number
	Height	Width	Depth			
800	78.00 (1981.2)	36.00 (914.4)	24.00 (609.6)	(3) Provisions per phase	(3) 4/0–500 kcmil Al/Cu	<b>GTB08P1MA</b>
				(3) Provisions per phase	(2) 3/0–750 kcmil Al/Cu	<b>GTB08P1MB</b>
1200	78.00 (1981.2)	36.00 (914.4)	24.00 (609.6)	(4) Provisions per phase	(4) 4/0–500 kcmil Al/Cu	<b>GTB12P2MC</b>
				(4) Provisions per phase	(3) 3/0–750 kcmil Al/Cu	<b>GTB12P2MD</b>
1600	78.00 (1981.2)	36.00 (914.4)	24.00 (609.6)	(5) Provisions per phase	(5) 4/0–500 kcmil Al/Cu	<b>GTB16P3ME</b>
				(5) Provisions per phase	(4) 3/0–750 kcmil Al/Cu	<b>GTB16P3MF</b>
2000	78.00 (1981.2)	36.00 (914.4)	24.00 (609.6)	(6) Provisions per phase	(6) 4/0–500 kcmil Al/Cu	<b>GTB20P4MG</b>
				(6) Provisions per phase	(5) 3/0–750 kcmil Al/Cu	<b>GTB20P4MH</b>
2500	78.00 (1981.2)	36.00 (914.4)	24.00 (609.6)	(8) Provisions per phase	(8) 4/0–500 kcmil Al/Cu	<b>GTB25P5MJ</b>
				(8) Provisions per phase	(7) 3/0–750 kcmil Al/Cu	<b>GTB25P5MK</b>

#### Roll-Up Generator Termination Box with Line Single-Hole Compression Lug Provisions; Load Single-Hole Compression Lugs <sup>①③</sup>

Ampere Rating	Dimensions			Single-Hole Compression Line Provisions Only Number and Range	Single-Hole Compression Load Termination Number, Range and Type	Catalog Number
	Height	Width	Depth			
800	78.00 (1981.2)	36.00 (914.4)	24.00 (609.6)	(3) Provisions per phase	(3) 4/0–500 kcmil Al/Cu	<b>GTB08P1CA</b>
				(3) Provisions per phase	(2) 3/0–750 kcmil Al/Cu	<b>GTB08P1CB</b>
1200	78.00 (1981.2)	36.00 (914.4)	24.00 (609.6)	(4) Provisions per phase	(4) 4/0–500 kcmil Al/Cu	<b>GTB12P2CC</b>
				(4) Provisions per phase	(3) 3/0–750 kcmil Al/Cu	<b>GTB12P2CD</b>
1600	78.00 (1981.2)	36.00 (914.4)	24.00 (609.6)	(5) Provisions per phase	(5) 4/0–500 kcmil Al/Cu	<b>GTB16P3CE</b>
				(5) Provisions per phase	(4) 3/0–750 kcmil Al/Cu	<b>GTB16P3CF</b>
2000	78.00 (1981.2)	36.00 (914.4)	24.00 (609.6)	(6) Provisions per phase	(6) 4/0–500 kcmil Al/Cu	<b>GTB20P4CG</b>
				(6) Provisions per phase	(5) 3/0–750 kcmil Al/Cu	<b>GTB20P4CH</b>
2500	78.00 (1981.2)	36.00 (914.4)	24.00 (609.6)	(8) Provisions per phase	(8) 4/0–500 kcmil Al/Cu	<b>GTB25P5CJ</b>
				(8) Provisions per phase	(7) 3/0–750 kcmil Al/Cu	<b>GTB25P5CK</b>

#### Notes

- ① Line side factory installed 3/8-inch bolt provisions for single-hole compression lugs (lugs furnished by others).
- ② Load side mechanical lugs are factory selected and installed.
- ③ Load side Anderson, single-hole compression lugs are factory selected and installed.

## Roll-Up Generator Termination Box

Approximate Dimensions in Inches (mm)

**Roll-Up Generator Termination Box with Line Single-Hole Compression Lug Provisions; Load Two-Hole Compression Lugs** <sup>①②③</sup>

Ampere Rating	Dimensions			Single-Hole Compression Line Provisions Only Number and Range	Two-Hole Compression Load Termination Cu Only Wire Size	Catalog Number
	Height	Width	Depth			
800	78.00 (1981.2)	45.00 (1143.0)	24.00 (609.6)	(3) 4/0–500 kcmil	(3) 350 kcmil Cu only	GTB08P1CL
				(3) 4/0–500 kcmil	(3) 400 kcmil Cu only	GTB08P1CM
1200	78.00 (1981.2)	45.00 (1143.0)	24.00 (609.6)	(4) 4/0–500 kcmil	(4) 500 kcmil Cu only	GTB12P2CN
				(4) 4/0–500 kcmil	(3) 600 kcmil Cu only	GTB12P2CP
				(4) 4/0–500 kcmil	(3) 750 kcmil Cu only	GTB12P2CQ
1600	78.00 (1981.2)	45.00 (1143.0)	24.00 (609.6)	(5) 4/0–500 kcmil	(5) 500 kcmil Cu only	GTB16P3CR
				(5) 4/0–500 kcmil	(4) 600 kcmil Cu only	GTB16P3CS
				(5) 4/0–500 kcmil	(4) 750 kcmil Cu only	GTB16P3CT
2000	78.00 (1981.2)	45.00 (1143.0)	24.00 (609.6)	(6) 4/0–500 kcmil	(6) 500 kcmil Cu only	GTB20P4CU
				(6) 4/0–500 kcmil	(5) 600 kcmil Cu only	GTB20P4CU
				(6) 4/0–500 kcmil	(5) 750 kcmil Cu only	GTB20P4CW
2500	78.00 (1981.2)	45.00 (1143.0)	24.00 (609.6)	(8) 4/0–500 kcmil	(7) 500 kcmil Cu only	GTB25P5CX
				(8) 4/0–500 kcmil	(6) 600 kcmil Cu only	GTB25P5CY
				(8) 4/0–500 kcmil	(6) 750 kcmil Cu only	GTB25P5CZ

4

**Roll-Up Generator Termination Box with Line Single-Hole Compression Lug Provisions; Load Single-Hole Compression Lugs** <sup>④</sup>

Ampere Rating	Dimensions			Single-Hole Compression Line Provisions Only Number and Range	Single-Hole Compression Load Provisions Only Number and Range	Catalog Number
	Height	Width	Depth			
800	78.00 (1981.2)	36.00 (914.4)	24.00 (609.6)	(3) Provisions per phase	(3) Provisions per phase	GTB08P1P1
1200	78.00 (1981.2)	36.00 (914.4)	24.00 (609.6)	(4) Provisions per phase	(4) Provisions per phase	GTB12P2P2
1600	78.00 (1981.2)	36.00 (914.4)	24.00 (609.6)	(5) Provisions per phase	(5) Provisions per phase	GTB16P3P3
2000	78.00 (1981.2)	36.00 (914.4)	24.00 (609.6)	(6) Provisions per phase	(6) Provisions per phase	GTB20P4P4
2500	78.00 (1981.2)	36.00 (914.4)	24.00 (609.6)	(8) Provisions per phase	(8) Provisions per phase	GTB25P5P5

**Notes**

- ① Line side factory installed 3/8-inch bolt provisions for single-hole compression lugs (lugs furnished by others).
- ② Load side factory installed Burndy, two-hole, short barrel compression lugs suitable for copper wire only.
- ③ Requires 45-inch (1143.0 mm) wide enclosure.
- ④ Line and load side factory installed 3/8-inch bolt provisions for single-hole compression lugs (lugs furnished by others).

# 4.6

## Switchboards

### Roll-Up Generator Termination Box

Approximate Dimensions in Inches (mm)

#### Roll-Up Generator Termination Box with Line Single-Hole Compression Lug Provisions; Load Provisions Only, Two-Hole Compression Lugs <sup>①②③</sup>

Ampere Rating	Dimensions			Single-Hole Compression Line Provisions Only Number and Range	Two-Hole Compression Load Provisions Only Number and Range	Catalog Number
	Height	Width	Depth			
800	78.00 (1981.2)	45.00 (1143.0)	24.00 (609.6)	(3) Provisions per phase	(3) Provisions per phase	GTB08P1PA
1200	78.00 (1981.2)	45.00 (1143.0)	24.00 (609.6)	(4) Provisions per phase	(4) Provisions per phase	GTB12P2PB
1600	78.00 (1981.2)	45.00 (1143.0)	24.00 (609.6)	(5) Provisions per phase	(5) Provisions per phase	GTB16P3PC
2000	78.00 (1981.2)	45.00 (1143.0)	24.00 (609.6)	(6) Provisions per phase	(6) Provisions per phase	GTB20P4PD
2500	78.00 (1981.2)	45.00 (1143.0)	24.00 (609.6)	(8) Provisions per phase	(8) Provisions per phase	GTB25P5PE

#### Roll-Up Generator Termination Box with Line Single-Hole Compression Lug Provisions; Load Mechanical Box Lugs <sup>②③④</sup>

Ampere Rating	Dimensions			Two-Hole Compression Line Provisions Only Number and Range	Mechanical Box Lugs Load Termination Number, Range and Type	Catalog Number
	Height	Width	Depth			
800	78.00 (1981.2)	45.00 (1143.0)	24.00 (609.6)	(3) Provisions per phase	(3) 4/0–500 kcmil	GTB08PAMA
				(3) Provisions per phase	(2) 3/0–750 kcmil	GTB08PAMB
1200	78.00 (1981.2)	45.00 (1143.0)	24.00 (609.6)	(4) Provisions per phase	(4) 4/0–500 kcmil	GTB12PBMC
				(4) Provisions per phase	(3) 3/0–750 kcmil	GTB12PBMD
1600	78.00 (1981.2)	45.00 (1143.0)	24.00 (609.6)	(5) Provisions per phase	(5) 4/0–500 kcmil	GTB16PCME
				(5) Provisions per phase	(4) 3/0–750 kcmil	GTB16PCMF
2000	78.00 (1981.2)	45.00 (1143.0)	24.00 (609.6)	(6) Provisions per phase	(6) 4/0–500 kcmil	GTB20PDMG
				(6) Provisions per phase	(5) 3/0–750 kcmil	GTB20PDMH
2500	78.00 (1981.2)	45.00 (1143.0)	24.00 (609.6)	(8) Provisions per phase	(8) 4/0–500 kcmil	GTB25PEMJ
				(8) Provisions per phase	(7) 3/0–750 kcmil	GTB25PEMK

#### Roll-Up Generator Termination Box with Line Two-Hole Compression Lug Provisions; Load Single-Hole Compression Lugs <sup>②③⑤</sup>

Ampere Rating	Dimensions			Two-Hole Compression Line Provisions Only Number and Range	Single-Hole Compression Load Termination Number, Range and Type	Catalog Number
	Height	Width	Depth			
800	78.00 (1981.2)	45.00 (1143.0)	24.00 (609.6)	(3) Provisions per phase	(3) 4/0–500 kcmil Al/Cu	GTB08PACA
				(3) Provisions per phase	(2) 3/0–750 kcmil Al/Cu	GTB08PACB
1200	78.00 (1981.2)	45.00 (1143.0)	24.00 (609.6)	(4) Provisions per phase	(4) 4/0–500 kcmil Al/Cu	GTB12PBCC
				(4) Provisions per phase	(3) 3/0–750 kcmil Al/Cu	GTB12PB CD
1600	78.00 (1981.2)	45.00 (1143.0)	24.00 (609.6)	(5) Provisions per phase	(5) 4/0–500 kcmil Al/Cu	GTB16PCCE
				(5) Provisions per phase	(4) 3/0–750 kcmil Al/Cu	GTB16PCCF
2000	78.00 (1981.2)	45.00 (1143.0)	24.00 (609.6)	(6) Provisions per phase	(6) 4/0–500 kcmil Al/Cu	GTB20PDCG
				(6) Provisions per phase	(5) 3/0–750 kcmil Al/Cu	GTB20PDCH
2500	78.00 (1981.2)	45.00 (1143.0)	24.00 (609.6)	(8) Provisions per phase	(8) 4/0–500 kcmil Al/Cu	GTB25PECJ
				(8) Provisions per phase	(7) 3/0–750 kcmil Al/Cu	GTB25PECK

#### Notes

- ① Line side factory installed 3/8-inch bolt provisions for single-hole compression lugs (lugs furnished by others).
- ② Load side factory installed 1/2-inch bolt provisions on 1-3/4-inch hole centers for two-hole compression lugs (lugs furnished by others).
- ③ Requires 45-inch (1143.0 mm) wide enclosure.
- ④ Load side mechanical lugs are factory selected and installed.
- ⑤ Load side Anderson, single-hole compression lugs are factory selected and installed.

## Roll-Up Generator Termination Box

Approximate Dimensions in Inches (mm)

Roll-Up Generator Termination Box with Line Two-Hole Compression Lug Provisions; Load Two-Hole Compression Lugs <sup>①②③</sup>

Ampere Rating	Dimensions			Two-Hole Compression Line Provisions Only Number and Range	Two-Hole Compression Load Termination Cu Only Wire Size	Catalog Number
	Height	Width	Depth			
800	78.00 (1981.2)	45.00 (1143.0)	24.00 (609.6)	(3) Provisions per phase	(3) 350 kcmil Cu only	GTB08PACL
				(3) Provisions per phase	(3) 400 kcmil Cu only	GTB08PACM
1200	78.00 (1981.2)	45.00 (1143.0)	24.00 (609.6)	(4) Provisions per phase	(4) 500 kcmil Cu only	GTB12PBCN
				(4) Provisions per phase	(3) 600 kcmil Cu only	GTB12PBCP
				(4) Provisions per phase	(3) 750 kcmil Cu only	GTB12PBCQ
1600	78.00 (1981.2)	45.00 (1143.0)	24.00 (609.6)	(5) Provisions per phase	(5) 500 kcmil Cu only	GTB16PCCR
				(5) Provisions per phase	(4) 600 kcmil Cu only	GTB16PCCS
				(5) Provisions per phase	(4) 750 kcmil Cu only	GTB16PCCT
2000	78.00 (1981.2)	45.00 (1143.0)	24.00 (609.6)	(6) Provisions per phase	(6) 500 kcmil Cu only	GTB20PDCU
				(6) Provisions per phase	(5) 600 kcmil Cu only	GTB20PDCU
				(6) Provisions per phase	(5) 750 kcmil Cu only	GTB20PDCW
2500	78.00 (1981.2)	45.00 (1143.0)	24.00 (609.6)	(8) Provisions per phase	(7) 500 kcmil Cu only	GTB25PECX
				(8) Provisions per phase	(6) 600 kcmil Cu only	GTB25PECY
				(8) Provisions per phase	(6) 750 kcmil Cu only	GTB25PECZ

4

Roll-Up Generator Termination Box with Line Two-Hole Compression Lug Provisions; Load Single-Hole Compression Lugs <sup>①③④</sup>

Ampere Rating	Dimensions			Two-Hole Compression Line Provisions Only Number and Range	Single-Hole Compression Load Provisions Only Number and Range	Catalog Number
	Height	Width	Depth			
800	78.00 (1981.2)	45.00 (1143.0)	24.00 (609.6)	(3) Provisions per phase	(3) Provisions per phase	GTB08PAP1
1200	78.00 (1981.2)	45.00 (1143.0)	24.00 (609.6)	(4) Provisions per phase	(4) Provisions per phase	GTB12PBP2
1600	78.00 (1981.2)	45.00 (1143.0)	24.00 (609.6)	(5) Provisions per phase	(5) Provisions per phase	GTB16PCP3
2000	78.00 (1981.2)	45.00 (1143.0)	24.00 (609.6)	(6) Provisions per phase	(6) Provisions per phase	GTB20PDP4
2500	78.00 (1981.2)	45.00 (1143.0)	24.00 (609.6)	(8) Provisions per phase	(8) Provisions per phase	GTB25PEP5

Roll-Up Generator Termination Box with Line Two-Hole Compression Lug Provisions; Load Two-Hole Compression Lugs Provisions <sup>③⑤</sup>

Ampere Rating	Dimensions			Two-Hole Compression Line Provisions Only Number and Range	Two-Hole Compression Load Provisions Only Number and Range	Catalog Number
	Height	Width	Depth			
800	78.00 (1981.2)	45.00 (1143.0)	24.00 (609.6)	(3) Provisions per phase	(3) Provisions per phase	GTB08PAPA
1200	78.00 (1981.2)	45.00 (1143.0)	24.00 (609.6)	(4) Provisions per phase	(4) Provisions per phase	GTB12PBPB
1600	78.00 (1981.2)	45.00 (1143.0)	24.00 (609.6)	(5) Provisions per phase	(5) Provisions per phase	GTB16PCPC
2000	78.00 (1981.2)	45.00 (1143.0)	24.00 (609.6)	(6) Provisions per phase	(6) Provisions per phase	GTB20PDPD
2500	78.00 (1981.2)	45.00 (1143.0)	24.00 (609.6)	(8) Provisions per phase	(8) Provisions per phase	GTB25PEPE

**Notes**

- ① Line side factory installed 1/2-inch bolt provisions on 1-3/4-inch hole centers for two-hole compression lugs (lugs furnished by others).
- ② Load side factory installed Burndy, two-hole, short barrel compression lugs suitable for copper wire only.
- ③ Requires 45-inch (1143.0 mm) wide enclosure.
- ④ Load side factory installed 3/8-inch bolt provisions for 1-hole compression lugs (lugs furnished by others).
- ⑤ Line and load side factory installed 1/2-inch bolt provisions on 1-3/4-inch hole centers for two-hole compression lugs (lugs furnished by others).

# 4.6

## Switchboards

### Roll-Up Generator Termination Box

#### Dimensions

Approximate Dimensions in Inches (mm)

#### Enclosure

4

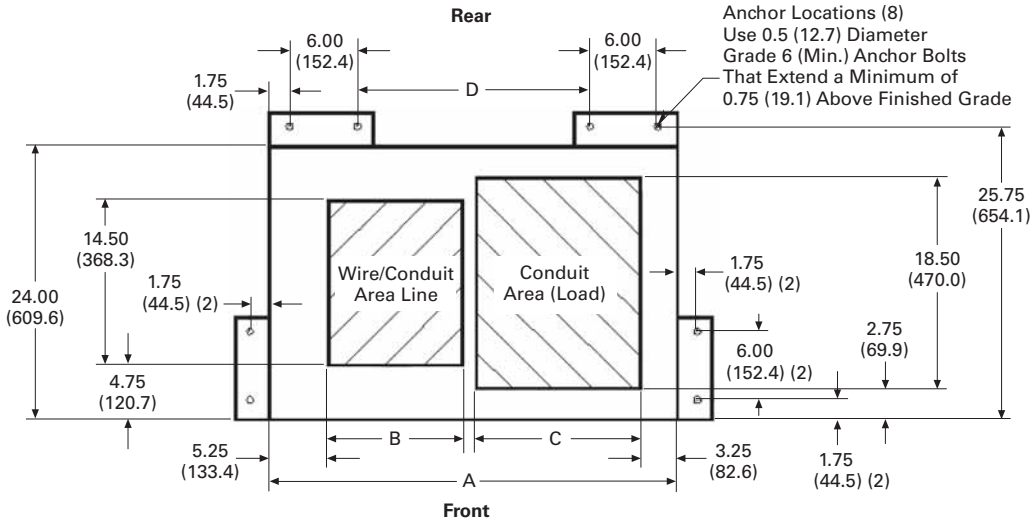

#### Termination/Lug Landing

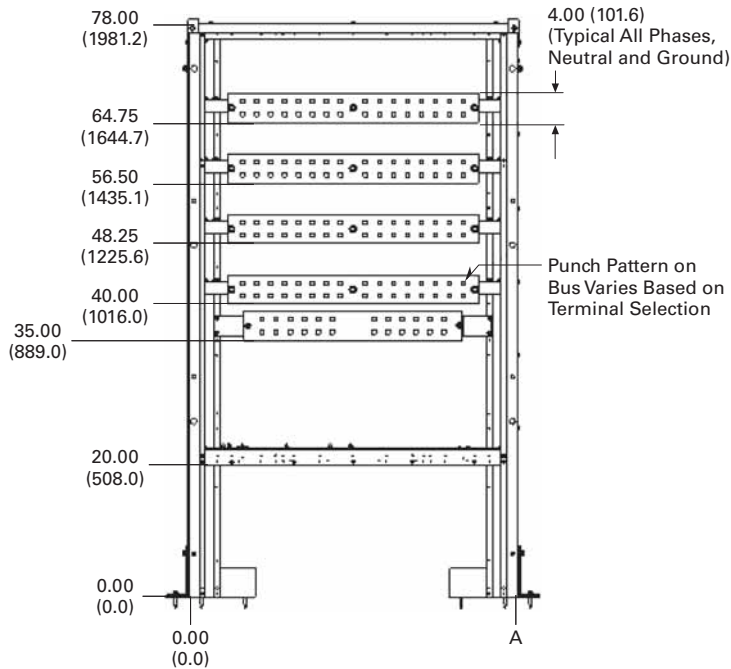

#### Enclosure Dimensions ①

Structure Width	A	B	C	D
36.00 (914.4)	28.00 (711.2)	11.75 (298.5)	14.50 (368.3)	20.50 (520.7)
45.00 (1143.0)	45.00 (1143.0)	18.25 (463.6)	18.00 (457.2)	28.50 (723.9)

#### Termination/Lug Landing Dimensions

Structure Width	A
36.00 (914.4)	36.00 (914.4)
45.00 (1143.0)	45.00 (1143.0)

#### Note

① Conduit landing surface will be 20.00 (508.0) above finished grade.

**Power Xpert Multipoint Metering Switchboard**



**Contents**

<b>Description</b>	<b>Page</b>
Power Xpert Multipoint Meter	
Features, Benefits and Functions . . . . .	<b>V2-T4-38</b>
Standards and Certifications . . . . .	<b>V2-T4-38</b>
Product Selection . . . . .	<b>V2-T4-38</b>
Options. . . . .	<b>V2-T4-38</b>

**Power Xpert Multipoint Metering Switchboard**

**Overview**

Allocation of energy consumption in a residential or commercial application is a tremendous task for a property owner, management firm or electrical energy manager. Eaton’s Power Xpert Multipoint Meter low-cost solution can assist in allocation or direct billing of consumed energy. The Power Xpert Multipoint Meter provides a cost-effective energy tabulation system for residential or commercial metering installations, including:

- High-rise buildings
- Universities and campuses
- Office buildings
- Apartment and condominium complexes
- Shopping malls
- Airports

Eaton’s Power Xpert Multipoint Meter can provide accurate information of consumed energy for monthly involving statements. Using the Power Xpert Multipoint Meter for utility allocation maximizes revenue by effectively measuring, allocating and recovering utility expenditures. The Power Xpert Multipoint Meter solution can interface with a third-party utility allocation service and offers the following advantages:

- Purchase energy at bulk rates while charging consumer rates
- Capitalize on naturally variable tenant loads by purchasing energy at a lower coinciding load
- Capture and allocate common area maintenance cost
- Promote tenant retention with accurate and defensible billing
- Eliminate subsidization of other tenants

**Product Description**

Using Eaton’s Power Xpert Multipoint Metering Switchboard design, multiple tenant submetering has never been easier. The Power Xpert Multipoint Metering Switchboard combines the Power Xpert Multi-Point Meter and Eaton’s PRL4, PRLC or Integrated Facility System™ (IFS™) to provide a space-saving, cost-effective energy tabulation system for residential or commercial metering installations.

**Application Description**

With energy cost on the rise, it is vital to proactively monitor and conserve electrical energy. Documentations of electrical energy usage can promote energy conservation for tenants or business departments. When the need for accurate energy consumption information for monthly tenant invoicing arises, use Eaton’s Power Xpert Multipoint Metering Switchboard solution.

Using the Power Xpert Multipoint Meter for utility allocation maximizes revenue by effectively measuring, allocating and recovering utility expenditures. The Power Xpert Multipoint Meter, using Eaton’s cost-allocation software or a third-party billing software, can generate single-rate or multi-rate billing.

### Features, Benefits and Functions

The Power Xpert Multipoint Metering Switchboard offers the property owner or the property management firm the ability to:

- Capture and allocate common area maintenance cost
- Promote tenant retention with accurate billing
- Eliminate subsidization of other tenants

The Power Xpert Multipoint Meter's space-saving design reduces the need for multi-metering equipment for each tenant. Additionally, the Power Xpert Multipoint Meter can monitor loads up to 5000A for energy billing or cost allocation. The meter is rated per ANSI C12.20 for revenue metering grade accuracy. With built-in communications capabilities, the Power Xpert Multipoint Meter can be connected to a local PC or network. The Power Xpert Multipoint Meter can connect to a third-party billing service to provide monthly energy consumption charges used by tenants. Additionally, unit status and communication activity are provided by a display on the metering compartment front panel.

The Power Xpert Multipoint Meter device can measure up to 60 total poles in any combination of single-, two- or three-pole breakers. The meters and current sensors are factory mounted with the current sensors factory wired to the meter inside the host structure. The meter monitors power and energy including instantaneous (kW), demand and cumulative (kWh) measurements for each load. The meter provides the following:

- Interval energy data logging
- Time-of-use energy registers
- Coincident peak demand storage
- Schedule remote meter reading data in non-volatile memory
- Measure bus voltage
- Factory-wired system
- Saves floor space
- Lower installed cost
- Network compatible
- Tenant sub-billing

### Standards and Certifications

- UL listed



### Product Selection

For complete application and pricing information, contact your local Eaton sales office.

### Options

- Energy Portal Module or Ethernet-based communications plus Modbus® TCP and BACnet/IP
- Pulse input module for WAGES inputs
- Digital output module for programmable alarm functions