

9373-FB3

MTL Compact Fieldbus Barrier System



DECLARATION OF CONFORMITY

A printed version of the Declaration of Conformity has been provided separately within the original shipment of goods. However, you can find a copy of the latest version at-

<http://www.mtl-inst.com/certificates>

CONTENTS

	DECLARATION OF CONFORMITY	ii
	GENERAL SAFETY INFORMATION	1
1	OVERVIEW	2
2	DESCRIPTION	3
3	PERMITTED CONFIGURATIONS	4
4	MECHANICAL INSTALLATION	5-6
4.1	Mounting overview	7
4.2	Preparation	7
4.3	Mounting	8
4.3.1	Fixing the enclosure to a surface	8
5	ELECTRICAL INSTALLATION	9
5.1	Overview	9
5.2	Grounding	9
5.2.1	Protective local ground	9
5.2.2	Cable shield grounding	10
5.3	Trunk cable wiring	11
5.3.1	Trunk cable access	11
5.4	Standard Small Enclosure – Trunk Wiring details	11-13
5.5	Standard Large Enclosure – Trunk Wiring details	13
5.5.1	Active trunk cable wiring	14
5.5.2	Spare trunk cable management	15
5.5.3	Trunk Termination	16
5.6	Spur wiring connections	17
5.6.1	Connecting the spur cables	17
5.6.2	Fitting FS32 Spur Surge modules	17
5.7	Final checks	18
6	MAINTENANCE	19
6.1	General	19
6.2	Spur connections	19
6.2.1	Removing a Spur Surge module	19
6.2.2	Adding a Spur Surge module	19
6.3	Trunk connections	20
6.4	Removal and replacement of a module	20-21
6.5	Replacement of a TP-32 Surge Suppressor	21-22
6.6	Regular Maintenance checks	23
7	TROUBLESHOOTING	23-24
8	ATEX INFORMATION	25
8.1	General	25
8.2	Installation	25
8.3	Special Conditions for Safe Use	25-26
8.4	Inspection and maintenance	26
8.5	Repair	26
8.6	Marking	26
8.7		
	APPENDIX A	28

THIS PAGE IS LEFT INTENTIONALLY BLANK

GENERAL SAFETY INFORMATION

Instructions for installation and operating personnel

The operating instructions provided here contain Safety essential safety instructions for installation personnel and those engaged in the operation, maintenance and servicing of the equipment.

	WARNING! Failure to comply with these instructions can endanger the lives or health of personnel and risk damage to the plant and the environment.
-----------------------------------------------------------------------------------	--------------------------------------------------------------------------------------------------------------------------------------------------------------

	WARNING! The responsibility for planning, installation, commissioning, operation and maintenance, particularly with respect to applications in explosion-hazard areas, lies with the plant operator.
-----------------------------------------------------------------------------------	----------------------------------------------------------------------------------------------------------------------------------------------------------------------------------------------------------------

Before commencing installation or commissioning:

- Read and understand the contents of this manual
- Ensure installation and operating personnel have received adequate training for this task
- Ensure that any operating instructions are fully understood by the personnel responsible.
- Observe national and local installation and mounting regulations (e.g. IEC 60079-14).

	WARNING! These assemblies may not be used in explosion-hazard area applications if they have been used previously in general electrical installations.
-------------------------------------------------------------------------------------	------------------------------------------------------------------------------------------------------------------------------------------------------------------

During operation:

- Make the relevant instructions available at all times to the operating personnel.
- Observe safety instructions.
- Observe national safety and accident prevention regulations.
- Operate the equipment within its published specification.
- Servicing, maintenance work or repairs not described in this manual must not be performed without prior agreement with the manufacturer.
- Any damage to this equipment may render its explosion protection null and void.
- No changes to any of the components that might impair their explosion protection are permitted.

If any information provided here is not clear:

Contact Eaton's MTL product line or one of its representatives.

NOTE
Improper installation and operation of the module can result in the invalidation of the guarantee.

MTL9373-FB3-Px-SS-12 spur Compact Fieldbus Barrier System



Figure 1.1- Fieldbus Barrier in Standard Small enclosure

1 OVERVIEW

This manual explains the installation and maintenance procedures for the 9373-FB3-Px-SS MTL Fieldbus Barrier enclosure and must be read in association with the product datasheets that contain electrical data.

The 9373-FB3-Px-SS Fieldbus Barrier enclosure is a field-mounted wiring hub providing twelve, intrinsically safe, 'simplex', spur connections from a single non-intrinsically safe trunk, for connection to Foundation™ fieldbus H1 fieldbus instruments. Key features of the barrier include short circuit protection on all of the spurs and the ability to 'live-work' any spur without disrupting the operation of the others or the need to power down the enclosure.

The incoming fieldbus trunk and the output spurs may, optionally, be fitted with surge-protection devices.

The enclosure material is electrochemically polished, 316L stainless steel and may be installed in a Zone 1, Zone 2, Zone 21 or Zone 22 hazardous and safe area.

The enclosure will be marked with the following model number.

9373-FB3-Px-SS- Compact Fieldbus Barrier system, 12-spur, stainless steel enclosure.

Where Px is either PS (for pluggable screw terminal connectors) or PC (for pluggable spring clamp connectors); however, a number of variants are available and so the user is referred to the product data sheet for ordering information and further details.

2 DESCRIPTION

The 9373-FB3-Px-SS is a third-generation product, in a successful range of Eaton - MTL Fieldbus Barrier Systems. The field-mounted enclosure contains a barrier that receives power and FOUNDATION™ Fieldbus H1 communications via a non-intrinsically safe trunk and converts this to a number of galvanically isolated, intrinsically safe, spur connections.

The trunk terminals are implemented as increased safety (Ex e) and the spur terminals as intrinsically safe (Ex ia) for connection to IS fieldbus instruments in IIC, Zone 0 hazardous areas. The spur connections are compatible with both FISCO and Entity-certified field instruments.

The fieldbus barrier is mounted in a 316L stainless steel, increased safety, Ex e enclosure that segregates spur and trunk cabling in accordance with hazardous area certification. Inside the enclosure, the incoming trunk wiring terminates in a separate compartment containing increased safety (Ex e) trunk wiring terminals. This compartment has a protective cover to deter interference, and carries a warning to the user not to work on trunk wiring without first isolating the power. A fieldbus termination is included for the trunk wiring to ensure correct termination of the wiring and prevent unwanted reflections and signal disturbances.

The system described in this manual provides 12 spurs of “simplex” type- meaning they are not intended to provide redundancy between spurs. Each spur is short circuit protected, so that other devices continue to operate in the presence of field wiring faults.

Surge protection can be added on individual outgoing spurs by the use of individual Spur Surge protection modules (part no. FS32). Similarly, trunk surge suppression is available to protect the fieldbus barrier against damaging voltage and current surges on the incoming trunk wiring.

The stainless steel enclosure may be installed in a Zone 1 or Zone 2 hazardous area; in which case, the trunk wiring must be implemented using suitably protected cable. It provides excellent chemical and moisture resistance and is suitable for use in a wide range of corrosive environments.

The 9373-FB3-Px-SS fieldbus barrier enclosure is bus-powered and requires no additional power supply in the field. When used with a fieldbus host control system, power for the trunk MUST be provided only by a supply conforming to IEC 61158-2, e.g. MTL F800 or MTL 918x range of redundant power supplies and certified for connection into Zone 1 or Zone 2 as required.

The enclosure is supplied pre-drilled for all trunk and spur cable entries and internal trunking provides adequate separation between the trunk and spur cables. It is also fitted with Ex e certified blanking plugs and a breather.

3 PERMITTED CONFIGURATIONS

A maximum of two 12-spur, Fieldbus Barrier modules is permitted per Fieldbus trunk. The permitted options are illustrated in Figure 3.1- (a), (b) and (c).

- a) A single barrier module in a field enclosure- with termination
- b) Two barrier modules in a single field enclosure- with termination only on second barrier

See section 5 – Electrical Installation- for information on providing the appropriate termination conditions for the trunk wiring.

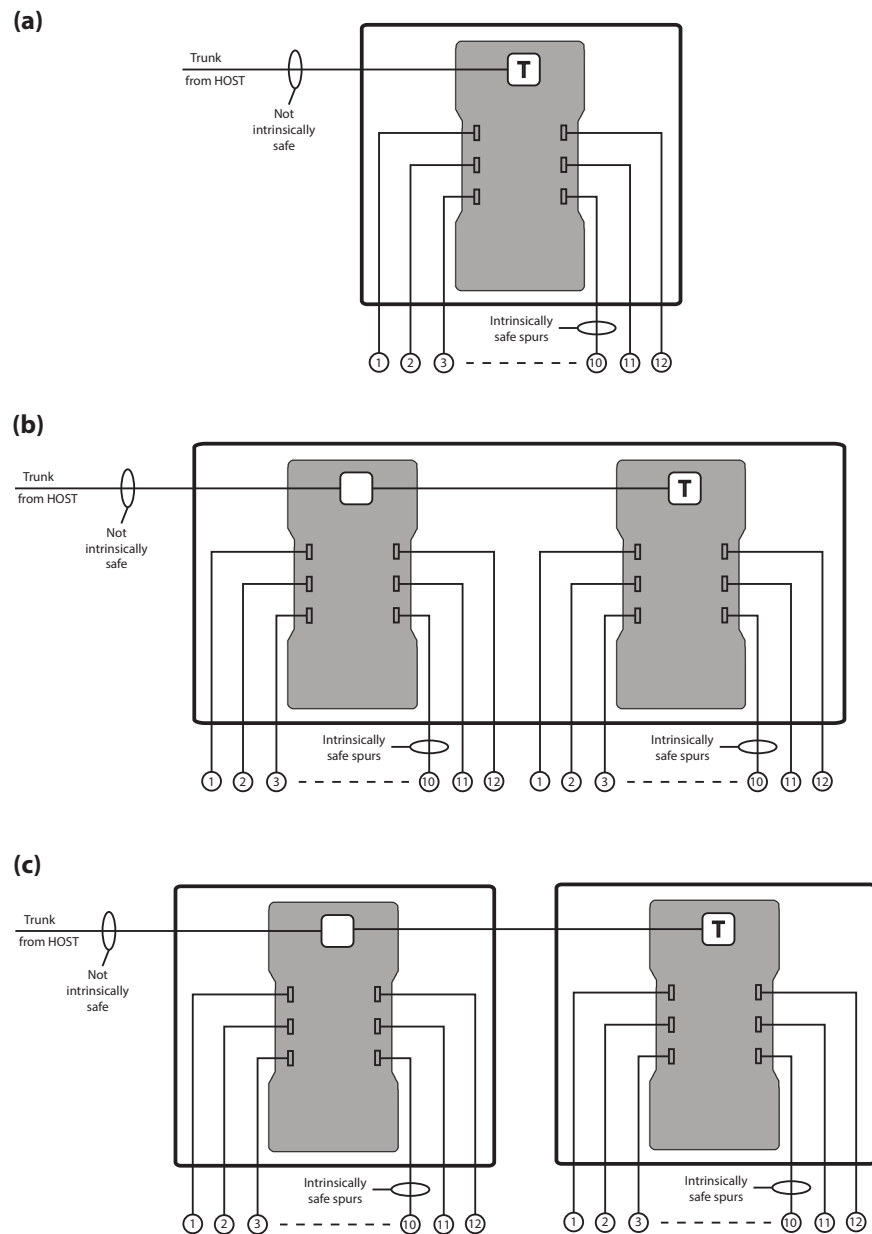

Figure 3.1 – Permitted implementations for Fieldbus Barriers

4 MECHANICAL INSTALLATION

See Figure 4.1 and 4.2 below for the dimensions, fixing locations and cable gland positions of the two main enclosure options.

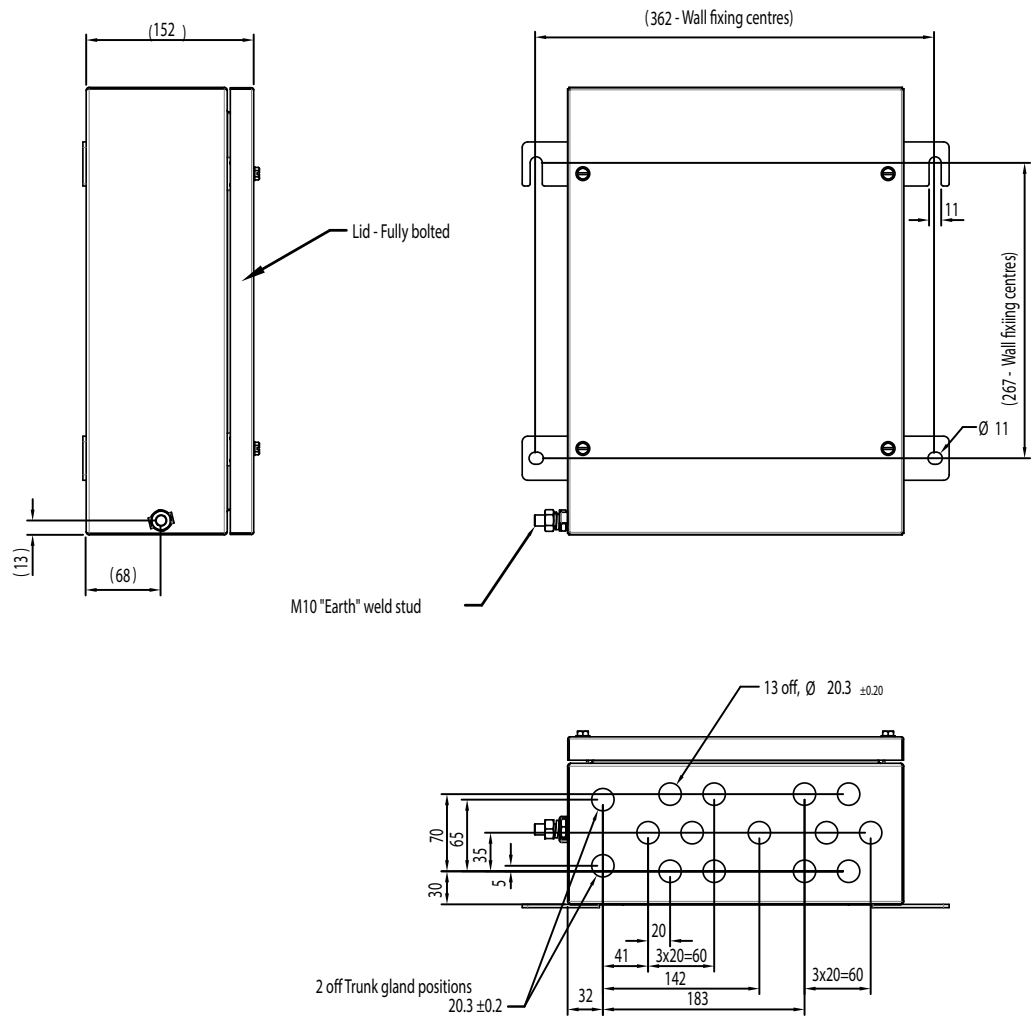

Figure 4.1 – Fieldbus Barrier Standard Small enclosure dimensions

Notes:

1. The enclosure is also available with a stainless-steel mounting bracket for a traffolyte tag label. (See Figure 4.2 for more details.)
2. A hinged lid with a quarter-turn lock (not shown here) is a further option when ordering. This does not affect the overall enclosure dimensions.

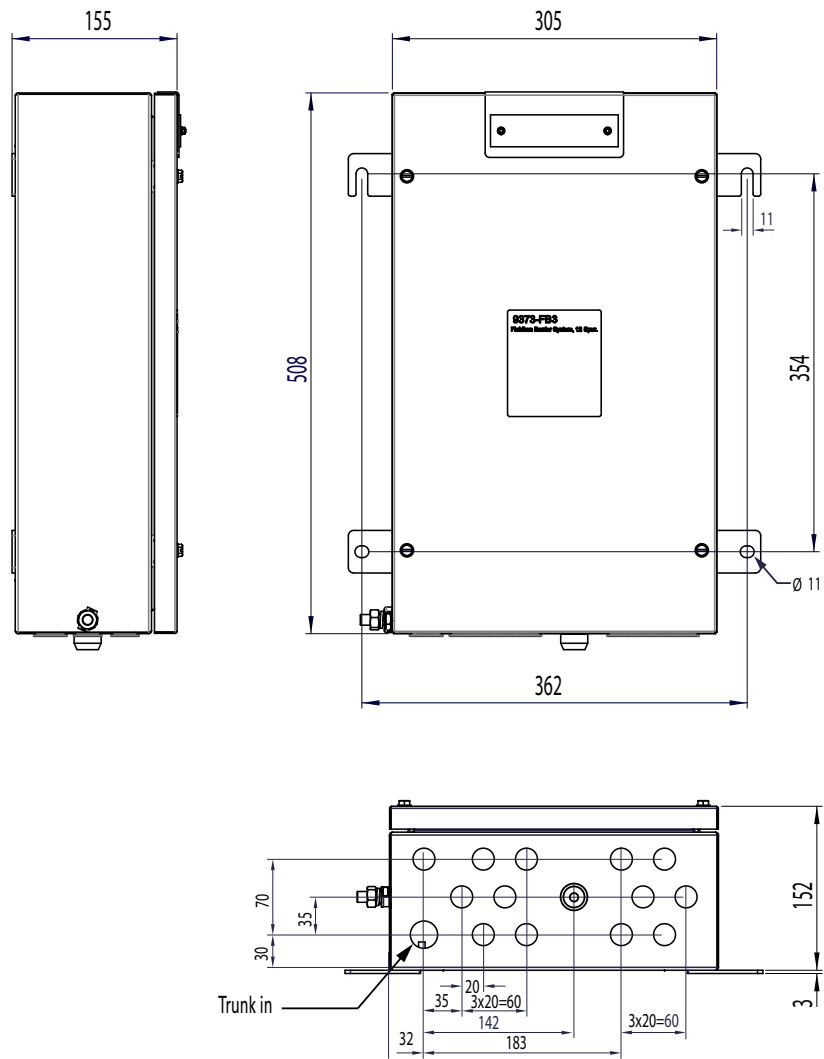

Figure 4.2 – Fieldbus Barrier Standard Large enclosure dimensions

Notes:

1. This drawing shows the enclosure lid fitted with a stainless-steel mounting bracket and a traffolyte tag label. This bracket is an option available when ordering and is not a default feature.
2. A hinged lid (LHS) with a quarter-turn lock (not shown here) is a further option when ordering. This does not affect the overall enclosure dimensions.

4.1 Mounting overview

Before mounting an enclosure, be aware of and check the following points.

- a) The enclosure is designed for mounting on a vertical surface, with the cable entry at the lowest point, as shown in the upper part of Figures 4.1. and 4.2. The permitted ambient temperature range in this orientation (–20°C to +60°C), external to the enclosure, must not be exceeded. Avoid radiant heat by locating the enclosure away from direct sunlight or local sources of heat.
- b) The enclosure has an ingress protection rating of IP65/IP66 (to EN60529). The mounting location should be chosen to comply with the rating of the enclosure and ensure that this rating is not compromised.
- c) Adequate security should be provided against unauthorised interference.
- d) All the necessary gland holes have been prepared in the enclosure. One has a breather fitted and the others are fitted with appropriate blanking plugs.
- e) Wherever a blanking plug is replaced by a cable gland, the gland fitted must be Ex e certified and have an ingress protection (IP) rating that maintains the overall rating of the enclosure.
- f) Enclosure blanking plugs that are factory fitted are tightened lightly for ease of removal, and so any blanking plugs that are not removed must be tightened to the required torque, before operation, to meet the IP rating.
- g) All cable gland holes must contain either a suitable cable gland or a blanking plug.



WARNING!

It is not permitted to create additional holes in the enclosure as this would violate the certification.

4.2 Preparation

- a) Remove any temporary protection or packing materials.
- b) The enclosure can be mounted on any suitable structure using the enclosure's integral mounting brackets.
- c) The fixing bolts must be suitable for the mounting surface and the environmental conditions.
- d) Prepare holes in the mounting surface, on the centres shown in Figure 4.1 or 4.2 to accept suitable screws/bolts for mounting.
- e) It is advisable before mounting, to do any necessary replacement of the cable entry blanking plugs with a suitable gland. For further details see Section 4.1 e) and f).

4.3 Mounting

	<p>WARNING!</p> <p>To minimise the risk of ignition by electrical apparatus in hazardous areas, efficient installation, inspection and maintenance of apparatus and systems is essential, and the work should be carried out by suitably trained personnel in accordance with the prevailing code of practice.</p> <p>The certification documents specify “Conditions for safe use” that must be adhered to and the copy certificate supplied should be studied and understood. Additionally, it is recommended that a working knowledge of IEC EN 60079 -14 be attained, as this standard provides guidance in respect to the installation of electrical equipment in hazardous areas.</p>
-----------------------------------------------------------------------------------	----------------------------------------------------------------------------------------------------------------------------------------------------------------------------------------------------------------------------------------------------------------------------------------------------------------------------------------------------------------------------------------------------------------------------------------------------------------------------------------------------------------------------------------------------------------------------------------------------------------------------------------------------------------------------------------------------

4.3.1 Fixing the enclosure to a surface

The enclosure can be used as a template. With help from at least one other person, hold it in the position required and mark the surface through the top slotted lugs only (see Figure 4.1 or 4.2). Open up these hole positions to a suitable size and depth.

For concrete/masonry

- a) Fit washers onto two expanding fixing bolts and screw the bolts into prepared holes to a depth that will allow the enclosure to be safely hung on them.
- b) Support the enclosure on these top bolts and mark the lower fixing points on the mounting surface through the mounting lugs.
- c) Remove the enclosure and put it to one side. Open up, to a suitable size and depth, the hole positions that were marked on the mounting surface.
- d) Re-hang the enclosure on the top bolts and fit the bottom fixing bolts (and washers) for the lower lugs and secure them.
- e) Finally, tighten all fixing bolts to the manufacturers recommended torque value.

For a steel structure

- a) After marking and preparing the top holes, put the enclosure in position and fix it with bolts, washers and nuts.
- b) Drill through the holes in the bottom lugs and fit the fixing bolts as for the top lugs.

After mounting the enclosure

Check that:

- it has not suffered any damage,
- the IP rating has not been affected; for example, by distortion of the enclosure,
- the mounting bolts/nuts are all tightened as recommended above.

5 ELECTRICAL INSTALLATION



WARNING!

Before starting any electrical installation work, ensure that the incoming trunk connection is isolated from any source of power.



CAUTION!

The temperature inside the enclosure could rise to 60°C. Ensure that all cables and cable glands fitted are rated to withstand these temperatures.

5.1 Overview

- The barrier module receives power from the incoming trunk cable and requires no further source of power.
- The equipment shall be powered only from supplies conforming to IEC 61158-2.
- Type 'A' fieldbus cable is recommended for fieldbus trunk connections.
- The terminal blocks for the trunk fieldbus cables have either screw terminal connectors or cage clamp connectors according to the fieldbus barrier model specified, but both are suitable for cables from 0.5mm²/20 AWG up to 2.5mm²/14 AWG.
- Input voltage range (trunk)- 16- 32Vdc
- Maximum rated current (trunk in to trunk out)- 2A

5.2 Grounding

It is important that two distinct ground concepts be recognised before beginning to connect-up the barrier module:

- Local protective earth-ground- mandatory
- Cable shield grounding

These two concepts and their implementation are explained below.

5.2.1 Protective local ground

This ground connection is required:

- To ensure that any exposed metalwork in or on the mounting enclosure does not present a hazard to personnel
- It also provides a low impedance earth grounding circuit for surge protection items that may be used in the enclosure.

A low impedance cable connection is provided internally from the barrier to the enclosure and an external M10 earth-grounding stud is provided on the side wall of the enclosure to enable a connection to be made to the local ground.

Use a ring terminal to make a good quality, plant safety earth connection (4mm² cross-sectional area or better) to this bolt and tighten it to a recommended torque of 5Nm (3.7lbft). It is important to prevent this connection from loosening and also to protect it from corrosion against the stainless-steel grounding stud.

Where the trunk and spur cables are protected by steel wire armour, this should be treated as part of the "protective" ground. Normal practice is to bond the armour to the plant structure at both ends of each cable. Where armour-protected cables enter the enclosure for the Fieldbus Barrier, the armour must be connected to the enclosure body using suitable cable glands.



CAUTION!

The enclosure cover/lid has a ground wire connection to the main body of the enclosure. Do not permit the lid to be suspended by this wire alone!

5.2.2 Cable shield grounding

The cable shield is normally electrically isolated from the protective earth ground, although the two may be deliberately interconnected in some grounding arrangements, as described below.

The module can be configured by the user to either of two grounding methods by means of a link in the trunk wiring area of the module – see Figure 5.1 to locate the grounding terminals.

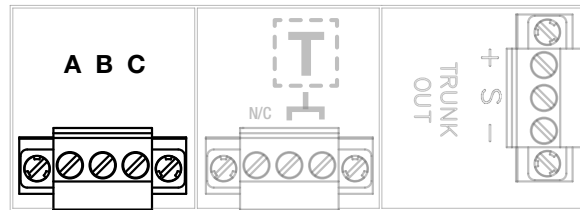

Figure 5.1 – Cable shield grounding option terminals

The user should adopt the grounding method that conforms to their system's normal grounding technique. Whichever method is used, it is important to connect the screen/shield to a ground at only one end of the cable.

The following two options are available to the user.

Option 1

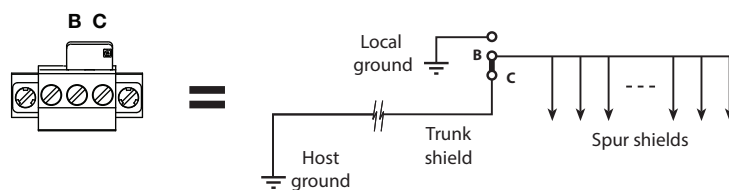

Figure 5.2 – Effect of Option 1 wiring

In many installations, the preferred and default method of grounding is to ground the fieldbus cable shields at one point only, normally at the fieldbus power supply. In this case, the trunk and spur cable shields are connected to each other at the Fieldbus Barrier module and are not connected to ground in the field. For this arrangement, fit the link between terminals B and C, as shown above.

Option 2

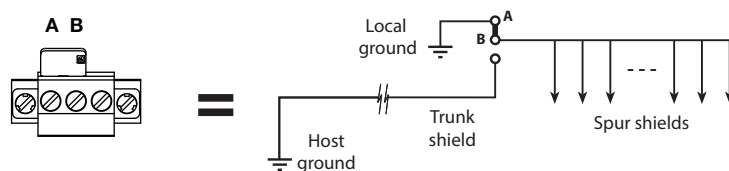

Figure 5.3 – Effect of Option 2 wiring

With this arrangement, the fieldbus trunk shield is separated from the spur cable shields. It should be adopted if plant or local regulations require that the spur cable shields be grounded at the Fieldbus Barrier. For this arrangement, fit the link between terminals A and B, as shown above.

5.3 Trunk cable wiring

The 9373-FB3-PX-SS product has a range of user options for trunk wiring. These range from a single trunk cable entry; allowance for an onward link to a second enclosure – as shown in Section 3; and the ability to manage and marshal multiple, spare trunk pairs if required.

In addition, the option for surge protection on the trunk wiring may have been specified and details of this are also covered below.

NOTE

The trunk features mentioned above, and discussed below, will have been specified at the time of ordering and cannot be modified in the field.



WARNING!

No part of the trunk wiring may be worked while the enclosure is powered, unless the environment is known to be non-hazardous.

5.3.1 Trunk cable access

The enclosure is provided with two access holes for trunk glands in the lower left floor area of the enclosure – see Figure 4.1 or 4.2; one is for the incoming trunk and another, if necessary, for onward linking to a second enclosure.

The cable entry holes are factory-fitted with either plastic or metal blanking plugs, and may be sized as M20, M25 or M32, depending upon the product type ordered. Fit cable glands that will suit both the diameter of the hole and the trunk cable.

5.4 Standard Small Enclosure – Trunk Wiring details

There are three simple formats for trunk wiring when the Standard Small enclosure has been chosen:

- a) Single Trunk Input – Without Surge Suppression
- b) Trunk Input – Trunk Output – Without Surge Suppression
- c) Single Trunk Input – With Surge Suppression

The third option c) is easily identified by the inclusion of the TP-32 surge suppressor in the upper left area of the enclosure – see Figure 5.4 below.

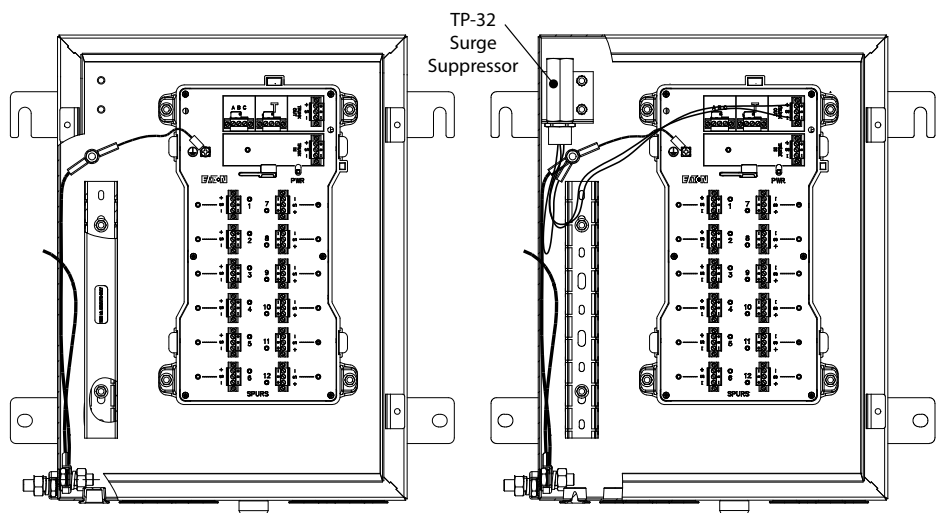

Figure 5.4 – Standard Small enclosure – without surge suppressor (left) – with suppressor (right)

In each case the active trunk cable is wired directly to the 'TRUNK IN' Fieldbus Barrier terminals.

The trunk wiring area on the barrier is fitted with a protective plastic cover – see Figure 5.5. This cover, together with its warning instructions, is intended to remind the user that working on the trunk connections, without first isolating the trunk power, is NOT permitted.

IMPORTANT
Cable ferrules must be fitted to any stranded cable or screen wiring that is being used.

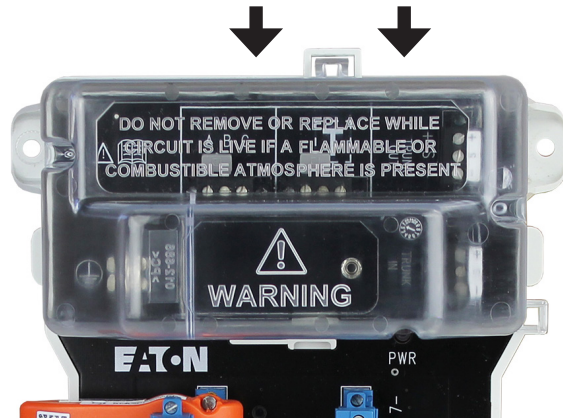

Figure 5.5 – Fieldbus Barrier Trunk wiring cover removal.

To remove the trunk wiring cover- First remove the securing screws then press on the upper edge of the transparent protective cover in the area between the arrows shown in Figure 5.5 to release the retaining clip, then remove the cover and move it to the side to obtain access.

Prepare the trunk cable in accordance with the gland manufacturer's instructions.

1. Feed the trunk cable through the gland in the enclosure wall and ensure that any cable armour has a low impedance connection to the enclosure's protective local ground.
2. Route the trunk cable through the trunking to provide appropriate separation from the spur wiring
3. Ensure also that there is sufficient length of cable inside the enclosure to allow for bends etc. and without causing any strain.

Connect the prepared ends of the incoming fieldbus trunk cable into the +, -, and 'S' terminals of the 'TRUNK IN' connector – see Figure 5.6- observing colour coding in accordance with site wiring regulation.

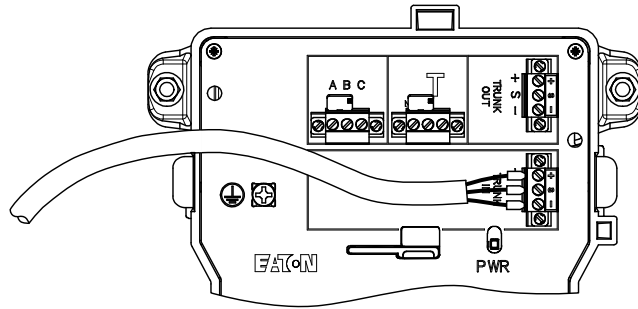

Figure 5.6 – Fieldbus Barrier Trunk wiring.

If there is no surge suppressor connected into the 'TRUNK OUT' terminals – as in the Figure 5.4 (right) diagram- then a trunk output cable may also be prepared in a similar manner and connected to the 'TRUNK OUT' terminals for onward connection to an additional enclosure.

- Proceed now to Section 5.5.3 to choose the correct position for the Trunk Terminator link

5.5 Standard Large Enclosure – Trunk Wiring details

Use this section for guidance if the Standard Large enclosure has been chosen.

The Standard Large Enclosure has more options than the Standard Small as it can be fitted with additional terminals to marshal and manage unused/spare trunk cables, and can include Trunk Surge Suppression while also permitting the use of the Trunk Out terminals. The additional terminals are mounted at the top of the enclosure on a DIN-rail above the Fieldbus Barrier- see Figure 5.7.

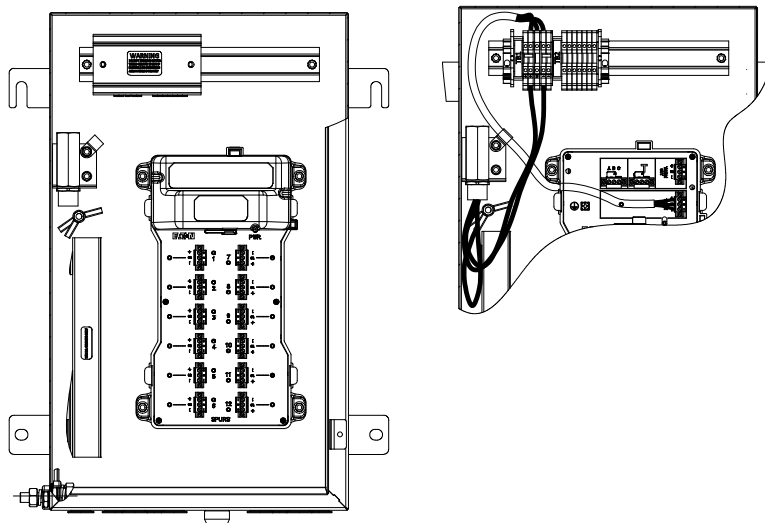



Figure 5.7 – Cutaway examples of Standard Large enclosure showing surge suppression terminal wiring and terminals for managing spare trunk cable pairs.

5.5.1 Active trunk cable wiring

As stated above, the Standard Large enclosure has provision for additional terminals to manage both trunk surge suppression wiring and additional (spare) trunk cabling – see Section 5.5.2 for details of the spare cable management.

On this enclosure, the surge suppressor is wired into the extra DIN-rail terminals, leaving the TRUNK OUT terminals on the Fieldbus Barrier vacant for onward linking, where necessary.

As seen in Figure 5.7, the DIN-rail terminals are fitted with their own protective cover, that meets an IP30 ingress protection rating. The cover is lifted off for access and MUST be replaced upon completion of the work because the circuits are not intrinsically safe. Pay attention to the warning label on the cover:

	WARNING! DO NOT REMOVE COVER WHILE CIRCUIT IS LIVE IF FLAMMABLE OR COMBUSIBLE ATMOSPHERE IS PRESENT"
-----------------------------------------------------------------------------------	-------------------------------------------------------------------------------------------------------------------

IMPORTANT
Cable ferrules must be fitted to any stranded cable or screen wiring that is being used.

1. Feed the trunk cable through the gland in the enclosure wall and ensure that any cable armour has a low impedance connection to the enclosure's protective local ground.
2. Route the incoming trunk cable through the cable trunking provided
3. Connect the active trunk cable as follows.

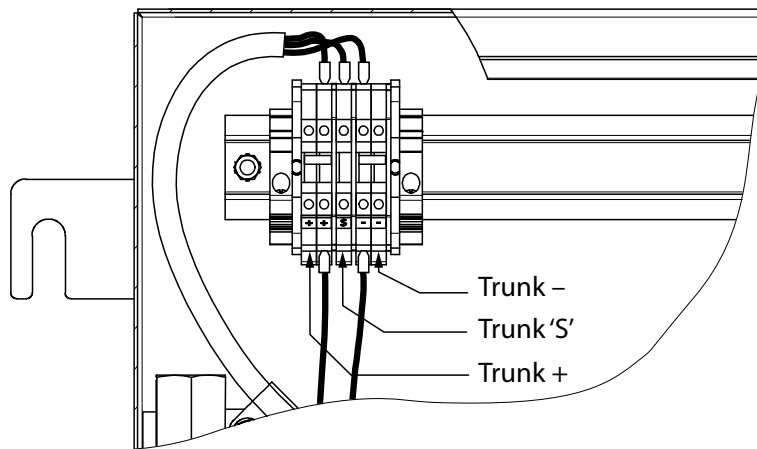

Figure 5.8 – Connections for active Trunk In

If trunk surge protection is not requested, and the terminals shown in Figure 5.8 are not available, connect the incoming active trunk cable to the Fieldbus Barrier as illustrated in Figure 5.6 previously.

5.5.2 Spare trunk cable management

NOTE

If the trunk cable entering the enclosure has no spare wires requiring management, ignore this section and move on to Section 5.5.3

The Standard Large enclosure may be ordered with additional terminals to manage multi-core cables where only one cable pair is used for the active trunk circuit. These spare pairs may require only to be managed in a convenient way, or they may be an element of the system design enabling a spare pair to be brought quickly into service in the event of a cable fault occurring.

As tabled above, the terminal options available when ordering are:

- a) Sufficient terminals for TWO spare cables,
- b) Sufficient terminals for FOUR spare cables.

The options are illustrated below (without any trunk surge suppressor connections, for clarity).

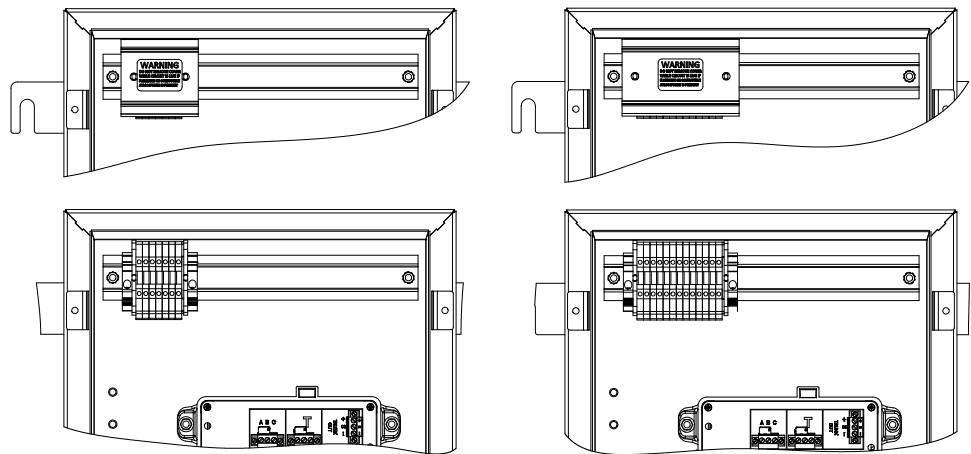

Figure 5.9 – Spare trunk cable terminals – TWO spares (left) and FOUR spares (right)

As shown in Figure 5.9, the terminals are fitted with their own protective cover, that meets an IP30 ingress protection rating. Lift off the cover for access. The cover **MUST** be replaced upon completion of the work because the circuits are not intrinsically safe. Pay attention to the warning label on the cover:



WARNING!

DO NOT REMOVE COVER WHILE CIRCUIT IS LIVE IF FLAMMABLE OR COMBUSIBLE ATMOSPHERE IS PRESENT"

All of the terminals are electrically 'floating'. They are not connected to ground within the enclosure, nor are they connected to each other or to any other circuit.

IMPORTANT

Cable ferrules must be fitted to any stranded cable or screen wiring that is being used.

1. Route the incoming multi-core trunk cable through the cable trunking provided
2. Prepare the spare cable pairs in the same manner as the active pair and connect the spare + , – and screen wires on the terminals provided.
3. An additional terminal is provided to enable an overall cable screen to be terminated.

5.5.3 Trunk Termination

The Fieldbus Barrier has a built-in terminator facility that is used when the module is the last, or only, barrier on the trunk.

The terminator is 'activated' by positioning the link on the right, as shown in Figure 5.10 below.

Consult Section 3 for guidance on how to set the terminator link for single or double enclosure installations.

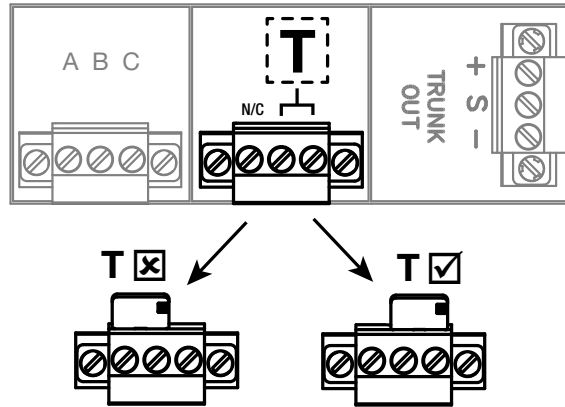

Figure 5.10 – Trunk Terminator link connector

Before refitting the Trunk wiring protective cover:

- Check all wiring connections
- Confirm that the Grounding link is in accordance with the Option required
- Check that the Terminator link is in the correct position

Replace the transparent protective cover over the terminal block and ensure that there is positive engagement of the retaining clip and replace the securing screws.

5.6 Spur wiring connections

Refer to Figures 5.11 for additional details.

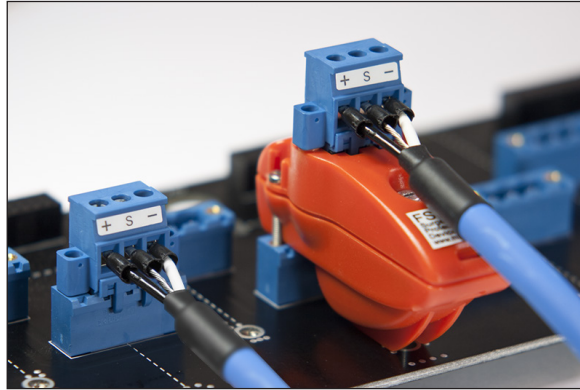

Figure 5.11 – Spur wiring options

The spur cables can be connected directly onto the fieldbus barrier carrier (see Figure 5.11) or through an FS32 Spur Surge module (also see Figure 5.11).

5.6.1 Connecting the spur cables

Prepare the spur cables in accordance with the gland manufacturer's instructions and secure the cables in the glands.

IMPORTANT

Cable ferrules must be fitted to any stranded cable or screen wiring that is being used.

Connect the prepared ends of the fieldbus spur cables into the +, 'S' and – terminals on the carrier (or surge module, if fitted), making sure that the same polarity is observed for all spurs.

5.6.2 Fitting FS32 Spur Surge modules

Spur Surge modules are pluggable units (see Figure 5.11) that integrate easily with the standard pluggable connector and which direct excessive spur surge currents to the protective local ground.

To fit an FS32:

- Unscrew the two captive screws securing the standard pluggable connector (supplied on the carrier) and remove it from its socket.
- Insert the FS32 module into the now vacant socket on the carrier; tighten the two side securing screws and the central "protective ground" screw, to a recommended torque of 0.5- 0.6 Nm.
- Fit the connector (removed at Step 1 above) into the socket on the FS32 and tighten its two securing screws also to a recommended torque of 0.5- 0.6 Nm.

Removal of a Spur Surge module is the reverse of the fitting process.

5.7 Final checks

Before fitting/closing the lid on the barrier enclosure, check that:

- all wire terminal connection screws are sufficiently tightened.
- all enclosure cable glands and any blanking plugs are tightened to provide a good seal.
- there are no loose cable ends that could cause an open or short circuit.
- the protective trunk wiring cover is in place and secure.
- no tools (e.g. screwdrivers) or loose items have been left in the enclosure.
- there is no damage to any enclosure cover seal, otherwise it must be replaced with one that has the same manufacturer's part number.
- if, and only if, a barrier is the last one on the fieldbus segment, ensure that its termination link is installed correctly.
- the required grounding link is securely connected both inside and outside the enclosure body.

Fit the enclosure lid and tighten all of its securing screws to their recommended torque.

6 MAINTENANCE

When an enclosure containing a Fieldbus Barrier module is installed in a hazardous area it is important for personnel to understand what activities are permissible when fieldbus power is present and what are not.

	<p style="text-align: center;">WARNING!</p> <p>Read and understand what work is permitted on the barrier module. Failure to comply with these instructions can endanger the lives or health of personnel and risk damage to the plant and the environment</p>
-----------------------------------------------------------------------------------	----------------------------------------------------------------------------------------------------------------------------------------------------------------------------------------------------------------------------------------------------------------------

6.1 General

The only items that can be disconnected, or removed, while the trunk is still powered are:

- **Spur** wiring or
- FS32 **Spur** Surge Protection modules.

All other wiring to the barrier requires the trunk power to be isolated, or a gas clearance certificate to be obtained before any work is carried out.

6.2 Spur connections

All of the spur connections are intrinsically safe and therefore may be live-worked in a hazardous area without 'gas clearance', while complying with normal 'permit to work' procedures.

If spur wiring is removed from a connecting plug, ensure that the same polarity is observed when it is reconnected.

6.2.1 Removing a Spur Surge module

Use the following procedure and reference to Section 4.6 may help.

1. Loosen the two screws securing the pluggable, spur-wiring connector to the Spur Surge module and unplug it.
2. Plug the Spur Surge module into the vacant socket on the barrier and tighten the two fixing screws and its grounding screw, all to a recommended torque of 0.5- 0.6 Nm.
3. Plug the spur connecting plug into its mating socket on the Spur Surge module and tighten the fixing screws to a recommended torque of 0.5- 0.6 Nm.

Make any necessary adjustments to the spur cable to avoid any tension.

6.2.2 Adding a Spur Surge module

Use the following procedure and reference to Section 4.6 may help.

- a) Loosen the two screws securing the pluggable, spur-wiring connector to the barrier and unplug it.
- b) Plug the Spur Surge module into the vacant socket on the barrier and tighten the two fixing screws and its grounding screw, all to a recommended torque of 0.5- 0.6 Nm.
- c) Plug the spur connecting plug into its mating socket on the Spur Surge module and tighten the fixing screws to a recommended torque of 0.5- 0.6 Nm.

Make any necessary adjustments to the spur cable to avoid any tension.

6.3 Trunk connections

Note the warning given on the covers protecting all of the trunk wiring areas.

	<p style="text-align: center;">WARNING!</p> <p style="text-align: center;">Do not remove or replace while circuit is live if a flammable or combustible atmosphere is present</p>
-----------------------------------------------------------------------------------	------------------------------------------------------------------------------------------------------------------------------------------------------------------------------------------

Work on the trunk wiring, protected by additional covers, requires the trunk power to the enclosure to be isolated, or a gas clearance certificate obtained.

Once the conditions are known to be safe, the necessary plastic cover(s) over the Trunk wiring may be removed. Refer to Sections 5.4 or 5.5 for additional information about the relevant trunk wiring connections.

When any changes or checks have been carried out, ensure there are no loose implements left before replacing protective cover for the trunk wiring. Replace the transparent protective cover over the trunk wiring and ensure that there is positive engagement of the retaining clip.

6.4 Removal and replacement of a module

If it is found necessary to swap-out a complete barrier module in the enclosure, proceed as below.

	<p style="text-align: center;">WARNING!</p> <p style="text-align: center;">The following procedure requires the power to the barrier/enclosure to be isolated. No work is permitted unless the power has been isolated or the environment is known to be non-hazardous.</p>
-------------------------------------------------------------------------------------	------------------------------------------------------------------------------------------------------------------------------------------------------------------------------------------------------------------------------------------------------------------------------------

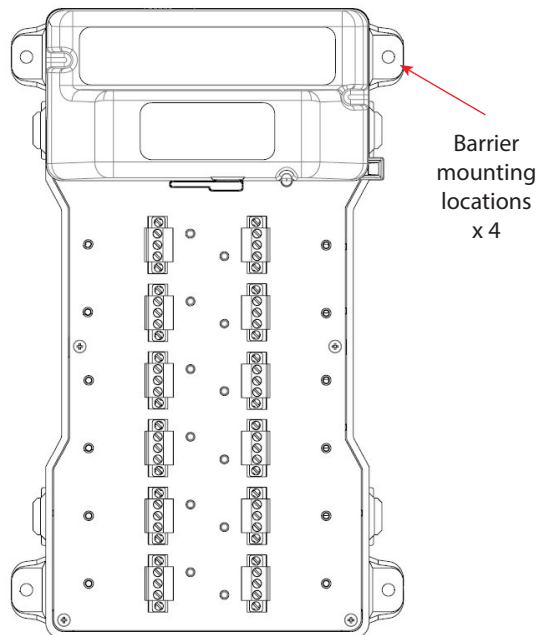

Figure 6.1 – Removing a barrier module

Use the following procedure and reference to Section 5.3.1 may help.

- a) Unclip and remove the Trunk Terminal cover
- b) Loosen the two screws securing the pluggable, TRUNK-IN wiring connector and unplug it. Do the same for a TRUNK-OUT connector if there is a cable connected. Arrange these safely to the side of the barrier.
- c) In turn, loosen the two screws securing each pluggable, spur-wiring connector and unplug the connectors. Arrange the connector wiring so that you have access to the barrier fixings.
- d) The barrier is secured to the backplane of the enclosure by four M5 flange nuts. (See Figure 6.1 for their locations.) Loosen these in turn and remove them to free the barrier and remove it from the enclosure.
- e) Replacement is the reverse of the removal process – tightening barrier fixing nuts to a recommended torque of 2.5 Nm and connector screws to 0.5- 0.6 Nm.

Follow site practice on the reuse of any locking washers; replacement may be advisable.

6.5 Replacement of a TP-32 Surge Suppressor



WARNING!

The following procedure requires the power to the barrier/enclosure to be isolated. No work is permitted unless the power has been isolated or the environment is known to be non-hazardous.

Replacement of this item will depend upon the enclosure type for wiring details. Refer to sections 5.4 or 5.5 for information on the wiring of the enclosure type.

The TP-32 has a threaded section on its body with a retaining nut to enable it to be fitted to a mounting bracket on the inside of the enclosure. Removal and replacement will be simplified by removing the item complete with its mounting bracket.

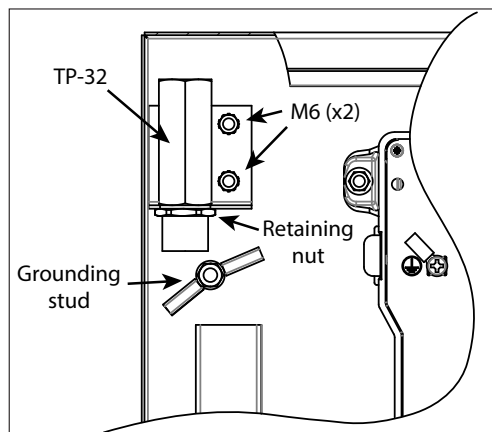

Figure 6.2 – TP-32 mounting details

- 1) Disconnect the red (+), black (-) and yellow/green wires of the TP-32 module. The + and - will either be on the Fieldbus Barrier or on the DIN rail terminals, depending upon the enclosure type. The yellow/green wire will be connected via a ring terminal to the M6 grounding stud.
- 2) The bracket is held in place with two nuts on M6 studs. Loosen and remove these nuts to detach the bracket from the enclosure.
- 3) Loosen and remove the retaining nut to free the TP-32 from its mounting bracket.

Fitting a replacement TP-32 is the reverse of the removal procedure. Torque the M6 nuts to 4.5Nm (3.3lbf).

Connect the TP-32 wires in the same manner as before its removal – refer to Figures 5.4 and 5.7 and the table below for additional details.

TP-32 wires	TRUNK OUT connector	Trunk In DIN rail connector
Red	+	+
Black	-	-

The yellow and green stripe wire on the TP-32 should be connected to the protective grounding stud located beside it. DO NOT connect this wire to the 'S' terminal of the trunk connector.

Before refitting the Trunk wiring protective cover:

- Check all wiring connections
- Confirm that the Grounding link is in accordance with the Option required
- Check that the Terminator link is in the correct position

Replace the transparent protective cover over the terminal block and ensure that there is positive engagement of the retaining clip.

6.6 Regular Maintenance checks

Check the general condition of the installation occasionally to ensure that no deterioration has occurred. At least every two years (and more frequently for harsh, dusty or dirty environments) check:

- Clean only with a moist cloth and detergent.
- the condition of all wire connections/terminations/screens
- that all of the fixing and cover screws and blanking plugs are secure and the enclosure breather/drain is clear
- that there are no signs of damage or corrosion
- that the level of any accumulated dust on the barrier enclosure does not exceed 5mm

In addition, take advantage of plant maintenance shutdown periods or whenever the area is known to be non-hazardous, to check wiring quality by ensuring that the dc voltage on the fieldbus trunk, when measured at the enclosure, is >16V. This can be performed using a multimeter or an FBT-6 fieldbus tester.

7 TROUBLESHOOTING

Each Fieldbus Barrier module is fitted with LED indicators to assist the user with

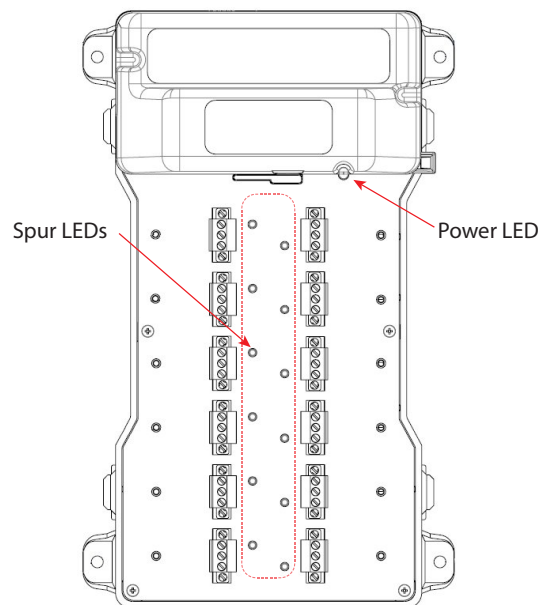

fault identification.

Figure 7.1 –Barrier LED locations

Consult the following tables to understand the meaning of the LED states.

Power LED (Green)

ON	OFF
Trunk power applied	Insufficient or no trunk power

NOTE

The Power LED will not light until the voltage at the barrier has risen to a value of at least 15.7V, but could remain lit even after the voltage has dropped to around 13.0V. DO NOT assume the Power LED indicates a voltage of 16V or more.

If the green Power LED is not lit, check:

- the polarity and integrity of the trunk cable connections to the enclosure.
- that the d.c. supply powering the incoming trunk is operating correctly.

Spur LEDs

Colour	State	Description
Green	Steady	Channel powering spur, spur OK
Green	Flashing	Channel powering spur, spur open
Red	Steady	Internal fault
Orange	Steady	Short to shield
Orange	Flashing*	Short circuit, current limit

* Flashing occurs at a rate of approximately 2 pulses per second.



CAUTION!

9373-FB3 Fieldbus Barrier modules are designed to operate reliably in industrial environments and comply with international standards for immunity to electromagnetic radiation. However, damage may occur if the apparatus is exposed to extreme levels of radiated electrical noise, for example from "walkie-talkie" radios, or electric arc-welding. If local welding activity is unavoidable, power should first be removed from the module.

8 ATEX INFORMATION

The Essential Health and Safety Requirements (Annex II) of the EU Directive 2014/34/EU [the ATEX Directive- safety of apparatus] requires that the installation manual of all equipment used in hazardous areas shall contain certain information. This annex is included to ensure that this requirement is met. It complements the information presented in this document and does not conflict with that information. It is only relevant to those locations where the ATEX directives are applicable.

8.1 General

- a) In common with all other electrical apparatus installed in hazardous areas, this apparatus must only be installed, operated and maintained by competent personnel. Such personnel shall have undergone training, which included instruction on the various types of protection and installation practices, the relevant rules and regulations, and on the general principles of area classification. Appropriate refresher training shall be given on a regular basis. [See clause 4.2 of EN 60079-17].
- b) The apparatus has been designed and manufactured so as to provide protection against all the relevant additional hazards referred to in Annex II of the Directive, such as those in clause 1.2.7.
- c) This apparatus has been designed to meet the requirements of electrical apparatus in accordance with EN 60079-0, EN 60079-7, EN 60079-11 and EN 60079-18.

8.2 Installation

- a) The installation should comply with the appropriate European, national and local regulations, which may include reference to the IEC code of practice IEC 60079-14. In addition, particular industries or end users may have specific requirements relating to the safety of their installations and these requirements should also be met. For the majority of installations, the Directive 1999/92/EC [the ATEX Directive – safety of installations] is also applicable.
- b) The equipment is certified: Baseefa19ATEX0023X and is designed for installation in Zone 1, Zone 2, Zone 21 or Zone 22 hazardous areas if mounted in a suitable enclosure.
- c) The apparatus must not be subjected to mechanical and thermal stresses in excess of those permitted in the certification documentation, this manual and the product specification.
- d) All cables and their glands must be chosen to withstand the temperatures at which the apparatus is designed to operate. See product specification for details.
- e) The apparatus must not be installed in a position where it may be attacked by aggressive substances.

Read also the Special Conditions for Safe Use (below) for any additional or more specific information.

8.3 Special Conditions for Safe Use

1. The equipment shall only be powered from supplies conforming to IEC 61158.
2. When a TP32 Trunk Surge Module is fitted, the power input circuit will not withstand a 500V a.c. isolation test to earth. This must be taken into account during installation.
3. When one or more FS32 Spur Surge Modules are fitted, the spur outputs will not withstand a 500V a.c. isolation test to earth. This must be taken into account during installation.
4. When the enclosure is fitted with a hinged lid, it shall only be mounted in a vertical orientation on a flat surface, and care is required in the installation process and when opening the hinged lid to ensure the enclosure does not distort.

continued

5. When the enclosure is fitted with a fully bolted lid the enclosure may be mounted in any orientation but it shall be on a flat surface and care is required in the installation process to ensure that the enclosure does not distort.
6. All Conditions for Safe Use that are present on the certificates for the glands and blanking plugs must be observed.

8.4 Inspection and maintenance

- a) Inspection and maintenance should be carried out in accordance with European, national and local regulations which may refer to the IEC standard IEC 60079-17. In addition, specific industries or end users may have specific requirements which should also be met.
- c) Maintenance of internal components while powered is limited to those actions permitted in Section 5 of this manual.

8.5 Repair

This product or any of its ancillary fittings cannot be repaired by the user and must be replaced with an equivalent certified product.

8.6 Marking

Each barrier is marked in compliance with the Directive and CE marked with the Notified Body Identification Number. This information applies to products manufactured during or after the year 2019.

For full certification information visit Eaton's MTL products website at :

www.mtl-inst.com/resources/datasheets

Search on the product family name and type number to view datasheets and certificates.

Compact Fielbus Barrier assembly marking (without TP32 fitted)

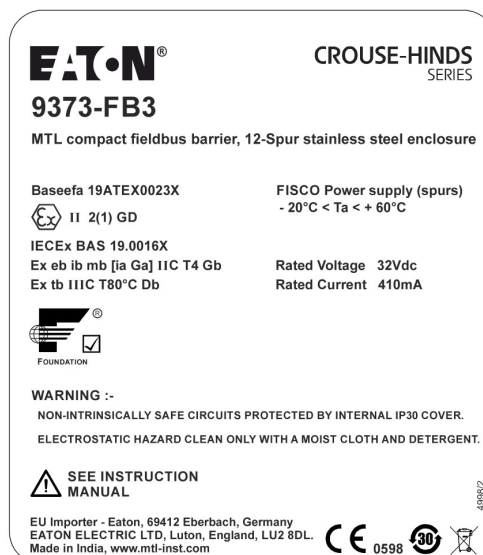

Compact Fielbus Barrier assembly marking (with TP32 fitted)

EAT•N[®] **CROUSE-HINDS**
SERIES

9373-FB3

MTL compact fieldbus barrier, 12-Spur stainless steel enclosure with TP32

Baseefa 19ATEX0023X FISCO Power supply (spurs)
- 20°C < Ta < + 60°C

 II 2(1) GD



IECEX BAS 19.0016X
Ex db eb ib mb [Ia Ga] IIC T4 Gb Rated Voltage 32Vdc
Ex tb IIIC T80°C Db Rated Current 410mA

 FOUNDATION

WARNING :-
NON-INTRINSICALLY SAFE CIRCUITS PROTECTED BY INTERNAL IP30 COVER.
ELECTROSTATIC HAZARD CLEAN ONLY WITH A MOIST CLOTH AND DETERGENT.

 SEE INSTRUCTION
MANUAL

EU Importer - Eaton, 69412 Eberbach, Germany
EATON ELECTRIC LTD, Luton, England, LU2 8DL.
Made in India, www.mtl-inst.com

CE 0598  

4098/2

APPENDIX A

9373-FB3-XXXX-XXXI - MTL Compact Fieldbus Barrier, 12-Spur Stainless Steel Enclosure with Isolation Switch Variant.

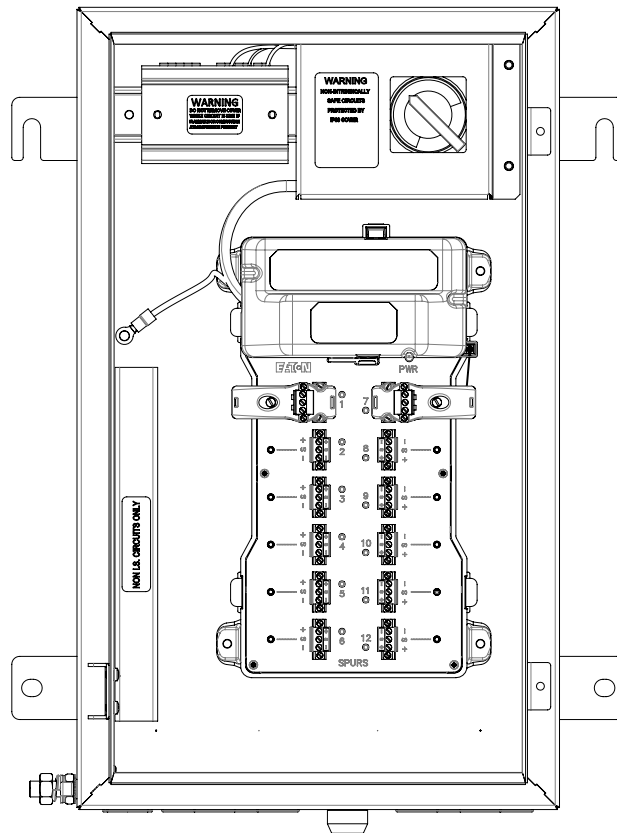

Figure A.1 - Fieldbus Barrier Module in Stainless Steel enclosure with Trunk Isolation Switch Included

Variant Specifics:-

1. The Isolation Switch is built into the Trunk In circuit and allows the operator to isolate the 9377-FB3 Barrier Module (ex. maintenance purposes) by changing the switch handle position from "ON" to an "OFF" position without the need of de-energising the entire system or obtaining gas clearance certificate.
2. The Isolation Switch is part of the Non Intrinsically Safe Trunk In circuit therefore the switch contact block and its connections are covered by an IP30 cover with a warning label. It is not allowed for the cover to be removed for any maintenance purposes without de-energising the entire system and obtaining gas clearance certificate!
3. The Trunk Terminal Block is part of the Non Intrinsically Safe Trunk In circuit therefore it is covered by an IP30 cover with a warning label. It is not allowed for the cover to be removed for any maintenance purposes without de-energising the entire system and obtaining gas clearance certificate!
4. This variant allows for Trunk connection to be extended to another JB via Trunk Out option. There are two ways of achieving this:-
 - a) of Trunk Terminal Block- in this scenario the Isolation Switch is not part of the Trunk circuit therefore Trunk Out is always "live" no matter Isolation Switch in "ON" or "OFF" position.

b) of Trunk Out terminals located on the Barrier Module- in this scenario the Isolation Switch is part of the Trunk circuit still therefore by changing the Isolation Switch to an "OFF" position- the Trunk Out is fully isolated.

For wiring details please refer to the Wiring Diagram shown below.

5. The Trunk In wiring is possible via Trunk Terminal Block (and Isolation Switch part of the circuit) only. Wiring Trunk In directly for the 9377-FB3 Barrier Module is not possible on this variant. For wiring details please refer to the Wiring Diagram shown below.

6. Up to 16 single deck fully isolated terminals are possible to be installed (factory fitted only) for the Trunk Terminal Block which allows for unused or spare Trunk connections to be safely secured, terminated for these (16 connections only). Please refer to the Wiring Diagram shown below.

7. When 9373-FB3, 12-Spur Stainless Steel System is to be supplied fitted with the Trunk Isolation Switch- the "Large" 508mm high enclosure only can be used. Please refer to figure 4.2, Page 33 for the dimensions, fixing locations and cable gland positions.

8. The other specific on this variant is the Trunk Surge Device can be used. This variant is certified with FS32-XE Surge Protection Device. The TP32 Surge Device mentioned earlier in this manual cannot be used.

9. This new variant is covered by separate BVS 22 ATEX E 051X and IECEx BVS 22.0048X equipment certificates therefore the product marking will be as shown below, specific for this variant only.

937X-FB3-XXXX-XXXI

MTL Compact fieldbus barrier, 12 spur, stainless steel enclosure
with Isolation Switch

BVS 22 ATEX E 051X	FISCO Power supply (spurs)
 II 2(1) GD	-20°C < Ta < 60°C
IECEx BVS 22.0048X	Um = 253Vrms
Ex db eb ib mb [ja Ga] IIC T4 Gb	Rated Voltage 32Vdc
Ex tb IIIC T80°C Db	Rated Current 410mA

WARNING :-

NON-INTRINSICALLY SAFE CIRCUITS PROTECTED BY INTERNAL IP30 COVER.
ELECTROSTATIC HAZARD CLEAN ONLY WITH A MOIST CLOTH AND DETERGENT.

 **SEE INSTRUCTION
MANUAL**

EATON ELECTRIC LTD. Luton, England, LU2 8DL.
Made in England, www.mtl-inst.com

 nnnn

10. Except the ones mentioned above- all of the other details and warnings given in this Instruction Manual still apply and must be adhered.

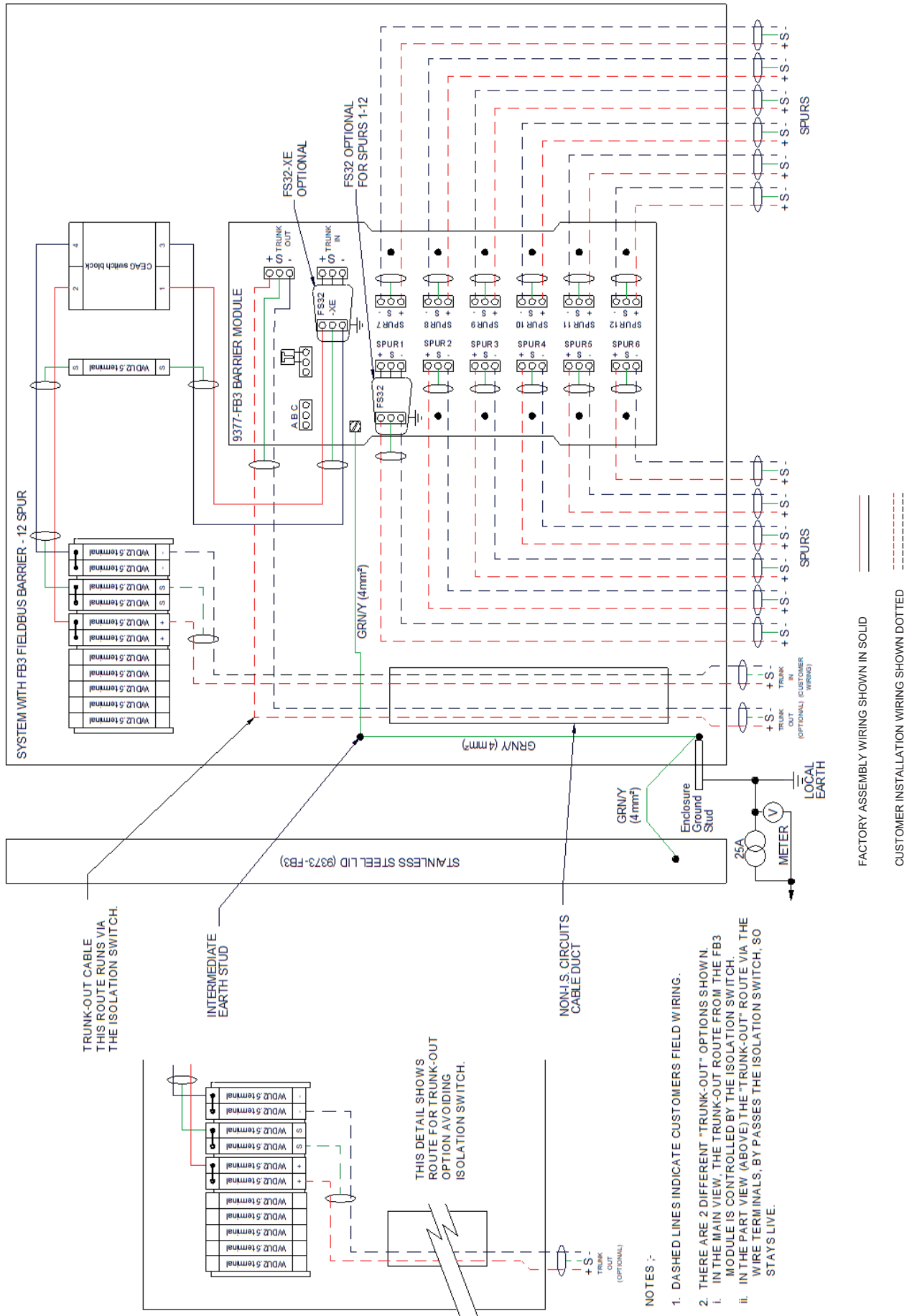

Figure A.2- Wiring Diagram for Fieldbus Barrier Module in Stainless Steel enclosure with Trunk Isolation Switch Included

Specific conditions of use:

1. The conditions stated in the respective certificates have to be adhered to.
2. The intrinsically safe circuits can be connected to earth. Potential equalisation along the intrinsically safe circuits has to be ensured.
3. The installation requirements in hazardous areas are to be complied with in accordance with EN/IEC 60079-14.

THIS PAGE IS LEFT INTENTIONALLY BLANK

AUSTRALIA

MTL Instruments Pty Ltd,
10 Kent Road, Mascot, New South Wales, 2020, Australia
Tel: +61 1300 308 374 Fax: +61 1300 308 463
E-mail: mtl-salesanz@eaton.com

BeNeLux

MTL Instruments BV
Ambacht 6, 5301 KW Zaltbommel
The Netherlands
Tel: +31 (0)418 570290 Fax: +31 (0)418 541044
E-mail: mtl.benelux@eaton.com

CHINA

Cooper Electric (Shanghai) Co. Ltd
955 Shengli Road, Heqing Industrial Park
Pudong New Area, Shanghai 201201
Tel: +86 21 2899 3817 Fax: +86 21 2899 3992
E-mail: mtl-cn@eaton.com

FRANCE

MTL Instruments sarl,
7 rue des Rosieristes, 69410 Champagne au Mont d'Or
France
Tel: +33 (0)4 37 46 16 53 Fax: +33 (0)4 37 46 17 20
E-mail: mtlfrance@eaton.com

GERMANY

MTL Instruments GmbH,
Heinrich-Hertz-Str. 12, 50170 Kerpen, Germany
Tel: +49 (0)22 73 98 12-0 Fax: +49 (0)22 73 98 12-2 00
E-mail: csckerpen@eaton.com

INDIA

MTL India,
No.36, Nehru Street, Off Old Mahabalipuram Road
Sholinganallur, Chennai- 600 119, India
Tel: +91 (0) 44 24501660 /24501857 Fax: +91 (0) 44 24501463
E-mail: mtlindiasales@eaton.com

ITALY

MTL Italia srl,
Via San Bovio, 3, 20090 Segrate, Milano, Italy
Tel: +39 02 959501 Fax: +39 02 95950759
E-mail: chmninfo@eaton.com

JAPAN

Cooper Crouse-Hinds Japan KK,
MT Building 3F, 2-7-5 Shiba Daimon, Minato-ku,
Tokyo, Japan 105-0012
Tel: +81 (0)3 6430 3128 Fax: +81 (0)3 6430 3129
E-mail: mtl-jp@eaton.com

NORWAY

Norex AS
Fekjan 7c, Postboks 147
N-1378 Nesbru, Norway
Tel: +47 66 77 43 80 Fax: +47 66 84 55 33
E-mail: info@norex.no

RUSSIA

Cooper Industries Russia LLC
Elektrozavodskaya Str 33
Building 4
Moscow 107076, Russia
Tel: +7 (495) 981 3770 Fax: +7 (495) 981 3771
E-mail: mtlrussia@eaton.com

SINGAPORE

Cooper Crouse-Hinds Pte Ltd
100G Pasir Panjang Road, Interlocal Centre
#07-08 Singapore 118523
Tel: +65 6645 9888 Fax: +65 6645 9811
E-mail: sales.mtlsing@eaton.com

SOUTH KOREA

Cooper Crouse-Hinds Korea
7F, Parkland Building 237-11 Nonhyun-dong Gangnam-gu,
Seoul 135-546, South Korea.
Tel: +82 6380 4805 Fax: +82 6380 4839
E-mail: mtl-korea@eaton.com

UNITED ARAB EMIRATES

Cooper Industries/Eaton Corporation
Office 205/206, 2nd Floor SJ Towers, off. Old Airport Road,
Abu Dhabi, United Arab Emirates
Tel: +971 2 44 66 840 Fax: +971 2 44 66 841
E-mail: mtlgulf@eaton.com

UNITED KINGDOM

Eaton Electric Ltd,
Great Marlings, Butterfield, Luton
Beds LU2 8DL
Tel: +44 (0)1582 723633 Fax: +44 (0)1582 422283
E-mail: mtlenquiry@eaton.com

AMERICAS

Cooper Crouse-Hinds MTL Inc.
3413 N. Sam Houston Parkway W.
Suite 200, Houston TX 77086, USA
Tel: +1 281-571-8065 Fax: +1 281-571-8069
E-mail: mtl-us-info@eaton.com