

937x-FB2-Px-SS Fieldbus Barrier System

6-spur & 12-spur, Stainless Steel enclosures



DECLARATION OF CONFORMITY

A printed version of the Declaration of Conformity has been provided separately within the original shipment of goods. However, you can find a copy of the latest version at <http://www.mtl-inst.com/certificates>

CONTENTS

	DECLARATION OF CONFORMITY	II
	GENERAL SAFETY INFORMATION	IV
1	OVERVIEW	1
2	DESCRIPTION	2
3	MECHANICAL INSTALLATION	2
3.1	Mounting overview	2/3
3.2	Permitted enclosure combinations	3/4/5
3.3	Preparation	6
3.4	Mounting	6
3.4.1	Fixing the enclosure to a surface	6
4	INITIAL ELECTRICAL INSTALLATION	7
4.1	Preparation	7
4.2	Grounding	7
4.2.1	Protective local ground	7/8
4.2.2	Cable shield ground	8
4.2.2.1	Single point of grounding at host; trunk & spur shields interconnected	8/9
4.2.2.2	Trunk shield grounded at host; spur cable shields grounded at barrier	9
4.3	Trunk connections	9
4.3.1	Trunk Terminal Assembly (TTA)	9/10
4.3.2	Trunk wiring	11
4.4	Trunk Terminator F93-XE	11
4.5	Trunk Surge module 9376-SP	12
4.6	Spur connections	12
4.6.1	Connecting the spur cables	12
4.6.2	Fitting FS32 Spur Surge modules	12
4.7	Blanking plugs	13
4.8	Final checks	13
5	MAINTENANCE	14
5.1	General	14
5.2	Fieldbus Barrier - fitting and removal	14/15
5.2.1	Removing a Fieldbus Barrier module (refer to Figure 5.1)	15
5.2.1.1	Fitting a Fieldbus Barrier module (refer to Figure 5.1)	15
5.3	Trunk Surge Protection module	15
5.3.1	Fitting and removal	15
5.3.1.1	Mounting a module	16
5.3.1.2	Removing a module	16
5.4	Spur connections	16
5.4.1	Removing a Spur Surge module & spur cable adjustment	16
5.4.2	Adding a Spur Surge module & spur cable adjustment	16
5.5	Trunk connections	17
5.6	Regular Maintenance checks	17
6	TROUBLESHOOTING	18
7	ATEX INFORMATION	19
7.1	General	19
7.2	Installation	19
7.3	Inspection and maintenance	20
7.4	Repair	20
7.5	Marking	21

GENERAL SAFETY INFORMATION

Safety instructions for installation and operating personnel

The operating instructions provided here contain **essential safety instructions** for installation personnel and those engaged in the operation, maintenance and servicing of the equipment.

 WARNING	WARNING ! Failure to comply with these instructions can endanger the lives or health of personnel and risk damage to the plant and the environment.
---	---

 WARNING	WARNING ! The responsibility for planning, installation, commissioning, operation and maintenance, particularly with respect to applications in explosionhazard areas, lies with the plant operator.
---	--

Before commencing installation or commissioning:

- Read and understand the contents of this manual
- Ensure installation and operating personnel have received adequate training for this task
- Ensure that any operating instructions are fully understood by the personnel responsible.
- Observe national and local installation and mounting regulations (e.g. IEC 60079-14).

 WARNING	WARNING ! Before putting into service, all entries must be fitted with:- 1. \geq IP66 Ex eb tb Equipment certified blanking plugs or \geq IP66 Ex eb tb Equipment certified cable glands. All blanking plugs and glands must have a minimum temperature range (-40°C to +75°C). 2. \geq IP66 Ex eb tb breather IECEx & ATEX equipment certified with a minimum temperature range of -40°C to +75°C and IP rating (IP66) at least equal to that of the enclosure.
--	--

 WARNING	WARNING ! These assemblies may not be used in explosion-hazard area applications if they have been used previously in general electrical installations.
---	---

During operation:

- Make the relevant instructions available at all times to the operating personnel.
- Observe safety instructions.
- Observe national safety and accident prevention regulations.
- Operate the equipment within its published specification.
- Servicing, maintenance work or repairs not described in this manual must not be performed without prior agreement with the manufacturer.
- Any damage to this equipment may render its explosion protection null and void.
- No changes to any of the components that might impair their explosion protection are permitted.

If any information provided here is not clear:

Contact **Eaton's MTL product line** or one of its representatives.

CAUTION! These enclosures are supplied with the latest type of fieldbus barrier, the 9377-FB-R. It is not possible to fit the earlier barrier type (model 9377-FB) into these enclosures.

937x-FB2-Px-SS Fieldbus Barrier System

6-spur & 12-spur, Stainless Steel enclosures



Figure 1.1 - Enclosure example showing model 9373-FB2-PC-SS

Note: 9376-SP trunk surge protection module is optional and not supplied as standard

1 OVERVIEW

This manual explains the installation and maintenance procedures for the 937x-FB2-Px-SS Fieldbus Barrier range of enclosures and must be read in association with the product datasheets that contain the electrical data. Any specials or variations of the standard 937x-FB2-Px-SS will be covered within an Addendum section at the end.

The 937x-FB2-Px-SS Fieldbus Barrier range of enclosures are field-mounted wiring hubs offering a choice of six or twelve intrinsically safe spur connections, from a single non-intrinsically safe trunk, for connection to FOUNDATION™ fieldbus H1 fieldbus instruments. The incoming fieldbus trunk and the output spurs may optionally be fitted with surge-protection devices.

The enclosure material used for the wiring hubs is stainless steel (SS) and they are capable of being installed in a Zone 1 or Zone 2 hazardous area.

The following enclosure types are available by ordering the appropriate model number.

- 9371-FB2-PS-SS Fieldbus Barrier system, 6-spur, Stainless Steel enclosure, pluggable screw terminal connectors
- 9371-FB2-PC-SS Fieldbus Barrier system, 6-spur, Stainless Steel enclosure, pluggable spring clamp connectors
- 9373-FB2-PS-SS Fieldbus Barrier system, 12-spur, Stainless Steel enclosure, pluggable screw terminal connectors
- 9373-FB2-PC-SS Fieldbus Barrier system, 12-spur, Stainless Steel enclosure, pluggable spring clamp connectors

2 DESCRIPTION

The model numbers shown above comprise SS, increased safety, Ex e enclosures containing either one (9371 models) or two (9373 models) carrier-mounted 9377-FB-R fieldbus barrier modules. Each fieldbus barrier module converts a single, non-intrinsically safe fieldbus trunk into six intrinsically safe (IS) spur connections for connection to Foundation™ fieldbus H1 fieldbus instruments.

On passing through the enclosure wall, the incoming trunk wiring enters the Trunk Terminal Area containing increased safety (Ex e) trunk wiring terminals. This assembly is provided with a protective cover to deter interference, and carries a warning to the user to isolate the power before working on any trunk wiring.

All enclosure models are supplied with a fieldbus Terminator module (part number F93-XE) pre-installed in the Trunk Terminal area. This should remain installed if the enclosure is at the end of the trunk segment. If the incoming fieldbus trunk will be onward linked to a further node on the segment the terminator should be removed. Further details are provided in Section 4 of this manual.

All spurs are galvanically isolated from the trunk allowing the user to choose the type of grounding scheme most suitable to their system.

Short-circuit protection for each outgoing spur is built-in to the 9377-FB-R barrier module, while surge protection is an option on individual spurs by installing Spur Surge protection modules (part no. FS32).

A Trunk Surge Protection module (part no. 9376-SP) is another user option and this can be plugged into a dedicated socket above the Trunk Terminal area to protect the fieldbus barrier against damaging voltage and current surges on the incoming trunk wiring.

The enclosures may be installed in a Zone 1 or Zone 2 hazardous area, in which case the trunk wiring must consist of a suitably protected cable type together with the appropriate environmental cable glands.

The Stainless Steel enclosure material provides excellent chemical and moisture resistance and is suitable for use in a wide range of corrosive environments.

The enclosures are bus-powered and require no additional power supply in the field. When used with a fieldbus host control system, power for the trunk must be provided ONLY by a supply conforming to IEC 61158-2, e.g. MTL F800 or MTL 918x range of redundant power supplies.

The enclosure is supplied pre-drilled for all trunk and spur cable entries and can be supplied blank or fitted with Ex e certified nickel-plated brass blanking plugs and a breather.

3 MECHANICAL INSTALLATION

See Figures 3.1 and 3.2 for the dimensions, fixing locations and cable gland positions for both enclosure models.

3.1 Mounting overview

Before mounting an enclosure, consider the following points.

- a) The permitted ambient temperature range external to the enclosure (–40°C to +70°C) must not be exceeded. Avoid radiant heat by locating the enclosure away from direct sunlight or local sources of heat.
- b) The enclosure has an ingress protection rating of IP66 (to EN60529) so the mounting location should be chosen to comply with this rating.
- c) The enclosure is designed for mounting on a vertical surface, with the cable entry at the lowest point, as shown in the upper part of Figure 3.1 or Figure 3.2.
- d) The nominal weight of the enclosures, excluding any surge protection modules (trunk or spur) is:

Model type	Nominal weight
9371-FB2-Px-SS	5.7 kg
9373-FB2-Px-SS	8.5 kg

- e) Adequate security should be provided against unauthorised interference.
- f) All the necessary gland holes have been prepared in the enclosure.
- g) Fieldbus barrier enclosures are suitable for mounting indoors or outdoors, however the internal equipment should not be exposed to water. If the enclosure needs to be opened whilst it is raining, take steps to prevent the interior from becoming wet (e.g. shelter using a temporary cover or screen)
- h) Fieldbus barrier systems may only be installed in environments with atmospheric pressure of 80kPa to 110kPa (maximum altitude of approximately 2000m above sea level).

	<p>WARNING !</p> <p>It is not permitted to create additional holes in the enclosure as this would violate the certification.</p>
---	---

3.2 Permitted enclosure combinations

The maximum number of intrinsically safe spurs that can be supported per trunk segment using 937x-FB2 range of Fieldbus Barrier enclosures is 18. The permitted enclosure combinations are shown in Figure 3.3.

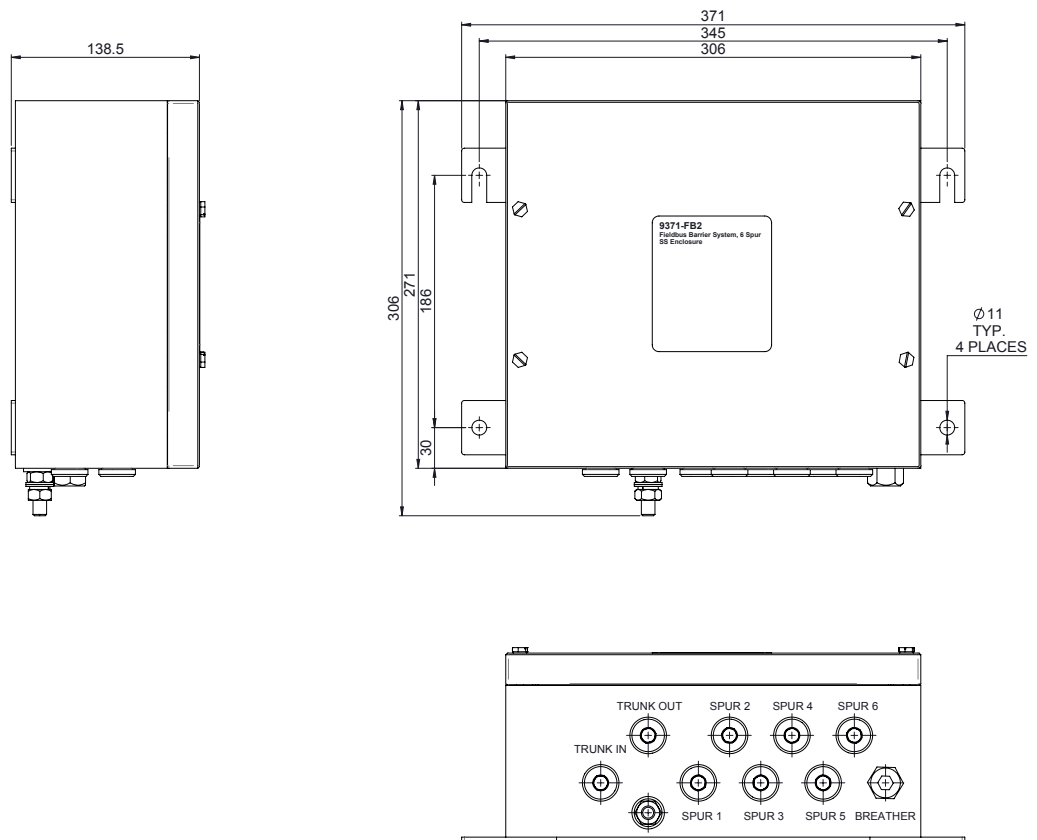

Figure 3.1 – External dimensions and mounting hole positions for the 6-way enclosure 9371-FB2-Px-SS

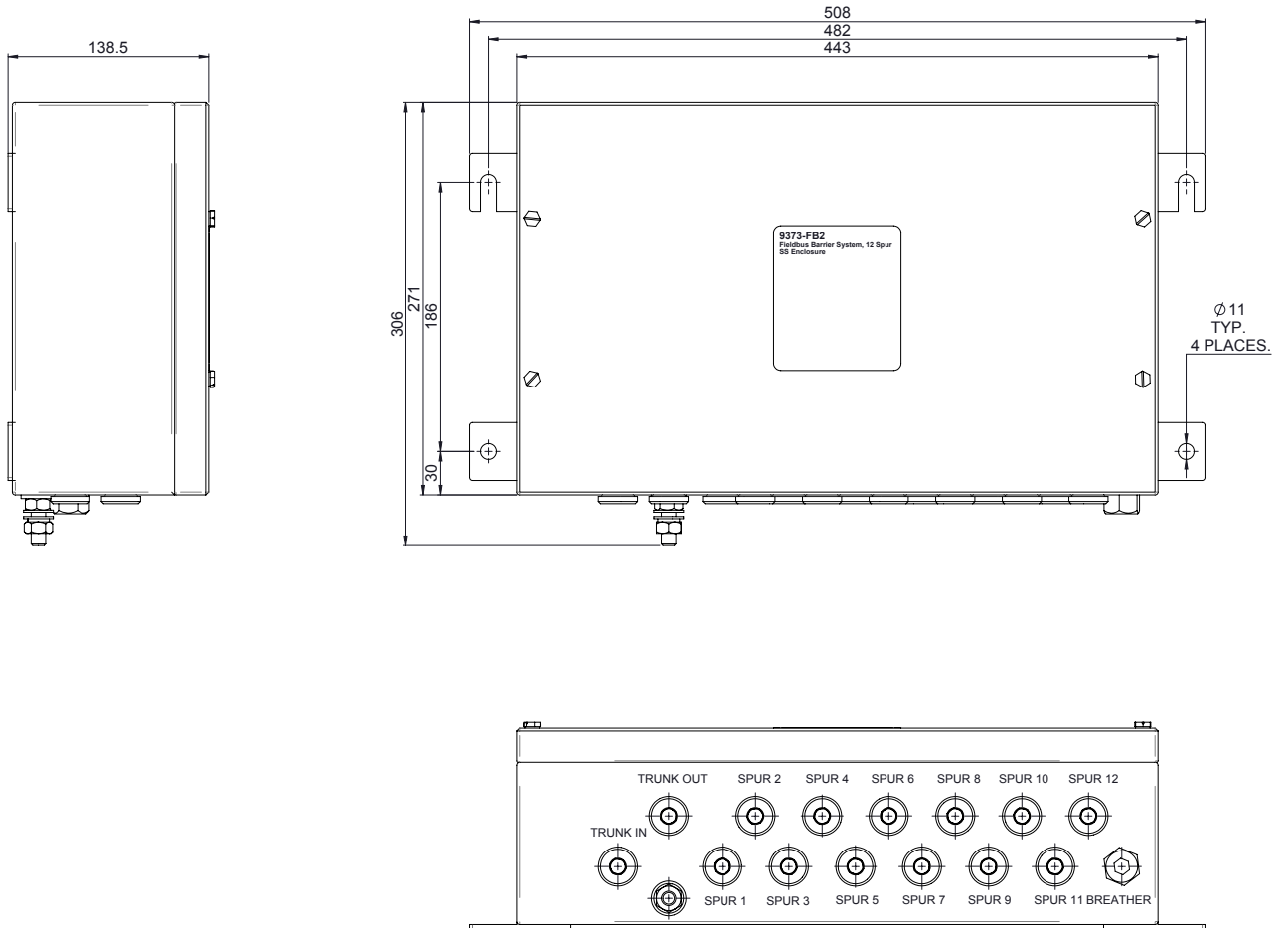

Figure 3.2 – External dimensions and mounting hole positions for the 12-way enclosure 9373-FB2-Px-SS

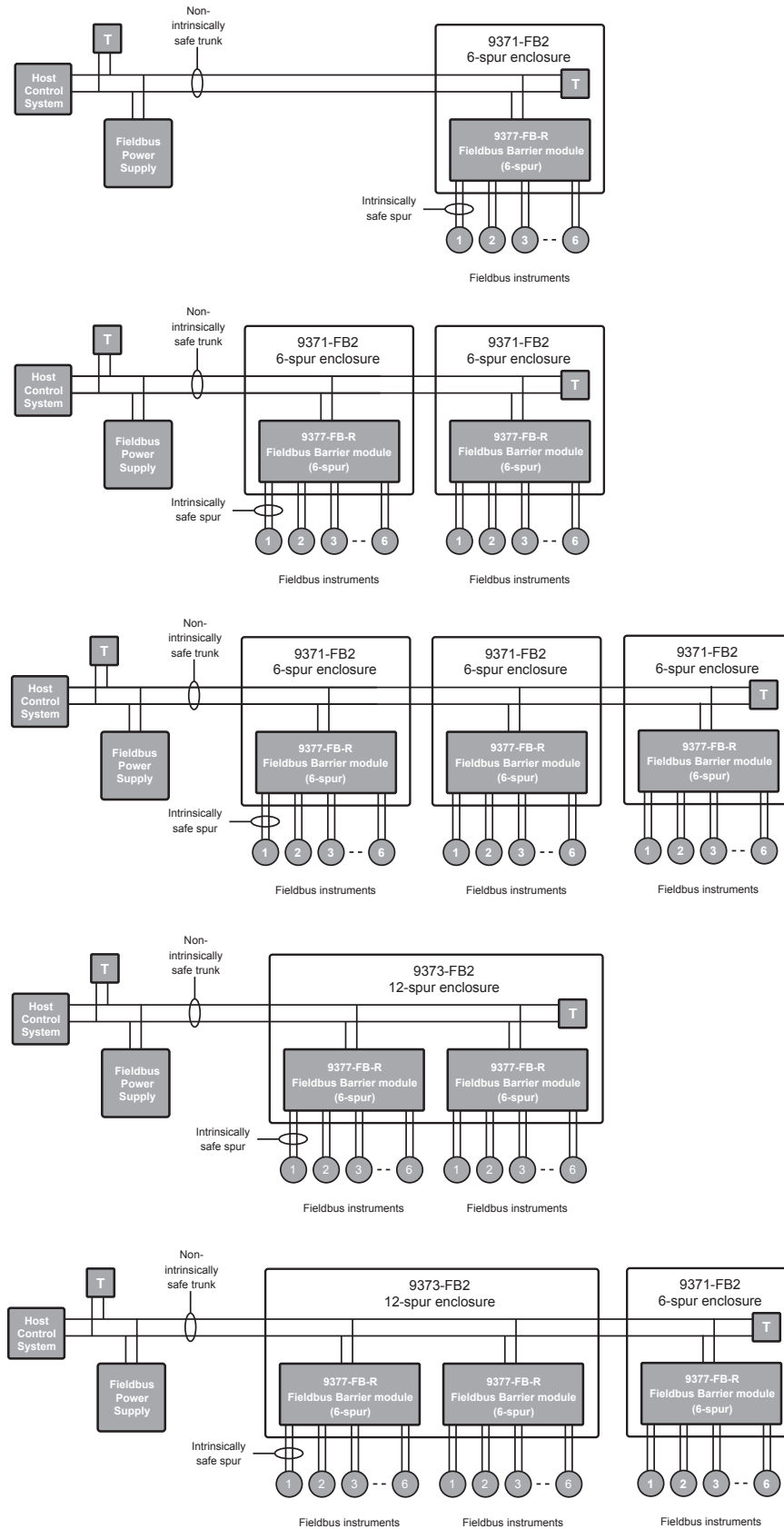



Figure 3.3 – Permitted enclosure combinations

3.3 Preparation

- a) Remove any temporary protection or packing materials.
- b) The enclosure can be mounted on any suitable structure using the enclosure's integral mounting facilities.
- c) The fixing bolts must be suitable for the mounting surface and the environmental conditions.
- d) It is advisable, before mounting, to do any necessary replacement of the cable entry blanking plugs with suitable gland types. For further details see Section 3.1 f).

3.4 Mounting

 WARNING	<p style="text-align: center;">WARNING !</p> <p>To minimise the risk of ignition by electrical apparatus in hazardous areas, efficient installation, inspection and maintenance of apparatus and systems is essential, and the work should be carried out by suitably trained personnel in accordance with the prevailing code of practice.</p> <p>The certification documents specify "Conditions for safe use" that must be adhered to and the copy certificate supplied should be studied and understood. Additionally it is recommended that a working knowledge of IEC EN 60079 -14 be attained, as this standard provides guidance in respect to the installation of electrical equipment in hazardous areas.</p>
---	--

3.4.1 Fixing the enclosure to a vertical surface

Mark hole positions as shown in Figures 3.1 or 3.2.

Open up these hole positions to a suitable size and depth.

a) It is recommended that a washer, not exceeding the 11mm diameter specified in Figures 3.1 and 3.2, is placed under the head of each of the bolts used to fix the enclosure to its mounting surface.

b) It is suggested that the upper fixings should be put in place first then lower, so that the enclosure can be supported by them.

After mounting the enclosure check that:

- It has not suffered any physical damage,
- The IP rating is not affected; for example, by distortion of the enclosure,
- The mounting bolts/nuts are all tightened as recommended above.

4 INITIAL ELECTRICAL INSTALLATION



WARNING !

Before starting any electrical installation work, ensure that the incoming trunk connection is isolated from any source of power.

CAUTION!

The temperature inside the enclosure could rise to 75°C. Ensure that all cables and cable glands fitted are rated to withstand these temperatures.

4.1 Preparation

Loosen the captive screws of the enclosure lid and then remove it to obtain access to the contents.

- The enclosure receives power from the incoming trunk cable and requires no further source of power.
- The equipment shall only be powered from supplies that conform to IEC 61158.
- Type 'A' fieldbus cable is recommended for fieldbus trunk and spur connections.
- The terminal blocks for the trunk fieldbus cables have either screw terminal connectors or spring clamp connectors according to the enclosure model specified, but both are suitable for cables from 0.5mm²/AWG 20 up to 2.5mm²/AWG 14.

On completion of installation, check all blanking plugs and cable glands are tightened to ensure IP rating of the enclosure is maintained.

For details of the enclosure wiring for the two system types.

4.2 Grounding

Two distinct grounding concepts should be recognised before wiring of the enclosure begins:

- a) A protective local ground – which is mandatory
- b) Cable shield ground

These two concepts and their implementation are explained below.

4.2.1 Protective local ground

This ground connection is required to ensure that any exposed metal work in, or on, the enclosure does not present a hazard to personnel; it also provides a low impedance earth-grounding circuit for any surge protection items used in the enclosure. An M8 earth-grounding stud is provided on the side wall of the enclosure to enable a connection to be made to the local ground.

Use a ring terminal to make a good quality, plant safety earth connection (4mm² cross-sectional area or better) to this bolt and tighten it to a recommended torque of 5Nm.

Note: It is important to prevent this connection from loosening and also to protect it from corrosion.

Where the trunk and spur cables are protected by steel wire armour, this should be treated as part of the “protective” ground. Normal practice is to bond the armour to the plant structure at both ends of each cable. Where armour-protected cables enter the Fieldbus Barrier enclosure, the armour must be connected to the enclosure’s internal grounding plate using suitable cable glands.

4.2.2 Cable shield ground

The cable shield is normally electrically isolated from the protective earth ground although in some cases the two may be deliberately interconnected, as explained below. In both cases the trunk cable shields and the spur cable shields should be connected to their appropriate terminals ('S') in the enclosure.

The enclosures can then be configured by the user to either of two grounding methods. The user should adopt the one that conforms to their system’s normal grounding method.

IMPORTANT: Whichever method is used, the screen/shield should only be grounded AT ONE END of the cable. Grounding at both ends creates “ground loops;” which will be troublesome and may even be dangerous.

The following options are available to the user.

 WARNING	WARNING ! The following may involve changes to wiring in the Trunk Terminal Assembly. No part of the Trunk Terminal Assembly may be worked while the enclosure is powered, unless the environment is known to be non-hazardous.
--	---

4.2.2.1 Single point of grounding at host; trunk & spur shields interconnected

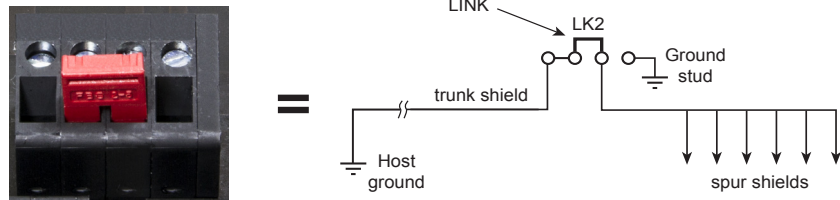

Figure 4.1 - Option 1

In many installations, the preferred method of grounding is to ground the fieldbus cable shields at one point only, normally at the fieldbus power supply. In this case, the trunk and spur cable shields are connected to each other at the Fieldbus Barrier and are not connected to ground in the field. For this arrangement, insert the link as shown in Figure 4.1.

Note: *this is the default grounding method for factory-supplied 937x-FB2 enclosures.*

IMPORTANT NOTE

937x-FB2 enclosures are factory-supplied with Option 1 grounding. If power is applied locally, for example during commissioning, when the trunk cable shield is NOT providing a ground connection, the spur cable shields must (temporarily) be grounded according to Option 2.

When the trunk cable shield ground has been fully instated (or restored), the grounding method should be returned to Option 1.

4.2.2.2 Trunk shield grounded at host, spur cable shields grounded at barrier

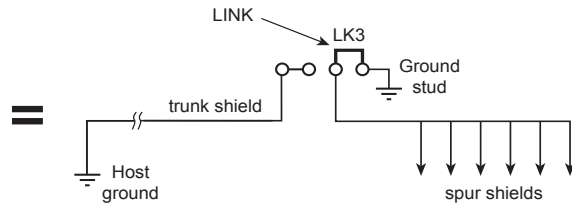
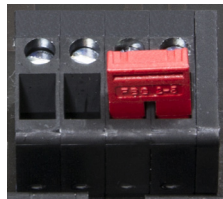

Figure 4.2 - Option 2

With this arrangement, the fieldbus trunk shield is separated from the spur cable shields. It should be adopted if plant or local regulations require that the spur cable shields be grounded at the Fieldbus Barrier. For this arrangement, insert the link as shown in Figure 4.2.

Note: After configuring the required grounding option, tighten the screw terminals to a recommended torque of 0.6 Nm.

4.3 Trunk connections

Each enclosure is provided with two access holes for trunk cable glands; one for the incoming trunk and another for onward linking to an additional enclosure, if necessary.



WARNING !

No part of the Trunk Terminal Assembly may be worked while the enclosure is powered, unless the environment is known to be non-hazardous.

4.3.1 Trunk Terminal Area (TTA)

Inside the enclosure the trunk cables are terminated in a Trunk Terminal Area (TTA). This is protected by a transparent cover with a warning label – both of these are there to deter a user from working on the trunk connections without isolating trunk power. See Figure 4.3.

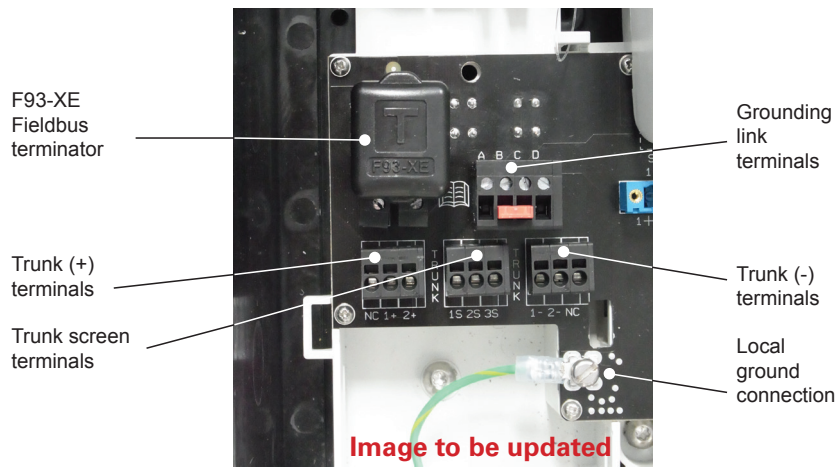

Figure 4.3 – Trunk Terminal Area connector details

Trunk cables pass through the enclosure wall via cable glands into the Trunk Terminal Area.

Terminals are provided to allow a variety of wiring arrangements, according to the particular requirements of the installation.

- “Trunk In” cable only
- “Trunk In” and “Trunk Out” cables
- Active and spare “Trunk In” cables
- Active and spare “Trunk In” cables with overall cable shield
- Active and spare “Trunk In” cables and “Trunk Out” cable

Figures 4.4 and 4.5 provide more details on the cable wiring options.

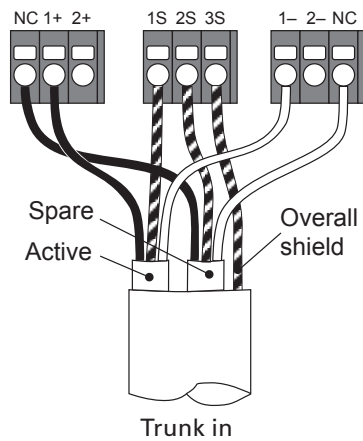

Figures 4.4 - ‘Trunk In’ with Active & Spare cable pair and overall cable shield

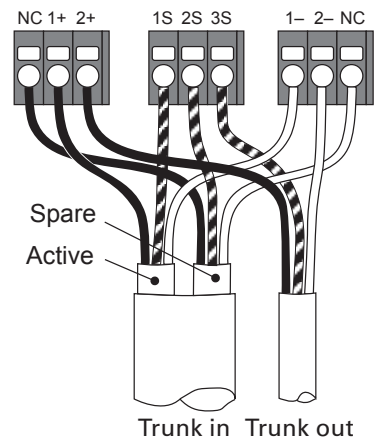

Figures 4.5 - Active & Spare ‘Trunk In’ cables plus ‘Trunk Out’ cable

CAUTION!

THE ‘+’ AND ‘-’ WIRES OF A ‘SPARE’ TRUNK IN CABLE MUST BE CONNECTED ONLY TO TERMINALS MARKED ‘NC’. THIS ENSURES THAT THE SPARE CABLE IS NOT ELECTRICALLY CONNECTED IN PARALLEL WITH THE ‘ACTIVE’ TRUNK IN OR TRUNK OUT CABLES. THE CABLE SHIELD OF THE SPARE CABLE SHOULD BE CONNECTED TO AN ‘S’ TERMINAL.

ALL ‘SPARE’ TRUNK-IN CONNECTIONS (+, - AND SHIELD) MUST BE FIRMLY GROUNDED AT THE HOST.

4.3.2 Trunk wiring

Connect the trunk cable(s) in the following way.

- Remove the cover that protects the Trunk Terminal Area by applying gentle pressure to the textured finger grips on each side of it: this releases the catches from the recesses in the carrier housing, so that the cover may be lifted away to reveal the trunk terminals. The cover is secured to the housing by a nylon tie to avoid its loss or damage to it.
- Prepare the trunk cable(s) in accordance with the gland manufacturer's instructions and secure the cable(s) in the gland(s). Ensure that the cables are not strained.
- Connect the prepared ends of the fieldbus trunk cable(s) into the appropriate '+', '-' and 'S' terminals, shown in Figures 4.4 or 4.5. The spring clamp (-PC option) terminals are operated by inserting a narrow-blade screwdriver into the upper opening, and lifting it to open the spring clamp in the terminal entry. Insert the cable ferrule while the clamp is open, and release. Check that the ferrule is securely held by applying gentle pressure to withdraw it.

Note: Figure 4.3 shows the PC options.

- Check Section 4. 2 to confirm that the chosen fieldbus ground option is correctly selected, and adjust if necessary.

4.4 Trunk Terminator F93-XE

If the trunk is being looped onward to another enclosure then no fieldbus terminator is required, but if the enclosure is the last (or only) enclosure on the trunk segment, the trunk must be terminated correctly to ensure that the optimum signal quality is maintained. The Trunk Termination Area has provision for a fieldbus terminator to be fitted when required. Terminator model F93-XE is used with these enclosures to provide the correct termination on the trunk segment.

Figure 4.3 shows the location of the terminator connection terminals and Figure 4.6 shows the fitting of the module. To fit the terminator, loosen the securing screws in the two allocated terminals and insert the terminator, with the terminator body facing towards the top of the assembly. Tighten the securing screws. Note that the terminals for the terminator are always screw-terminal type, regardless of whether the Fieldbus Barrier is a -PS (screw terminal) or -PC (spring clamp) version.

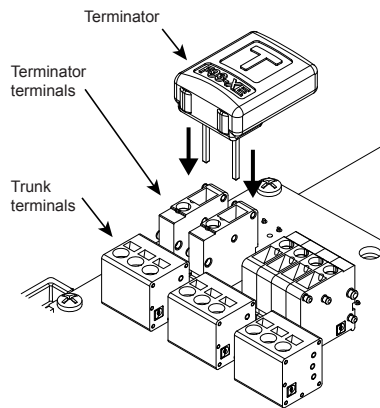

Figure 4.6 – Fitting an F93-XE terminator module

Check all connections then replace the Trunk Terminal cover by locating the clips into the carrier housing slots then pushing it gently until the clips fully engage.



WARNING !

The F93-XE Terminator must not be removed or replaced while the Fieldbus Barrier segment is under power, unless the area is known to be non-hazardous

4.5 Trunk Surge protection module 9376-SP

The 9376-SP Trunk Surge protection module can be fitted to the TTA to prevent damage to the equipment from voltage and current surges that could occur on the trunk wiring.

The 9376-SP is a four pin module that plugs into the upper end face of the Trunk Terminator Assembly. See Section 5.3 for fitting and removal details.

4.6 Spur connections

The spur cables can be connected directly onto the fieldbus barrier carrier terminals or, for additional protection from current surges, be connected through a Spur Surge module (FS32) as shown in Figure 4.7. (Note that the connectors shown in this figure are screw-terminal type.)

If Spur Surge modules are not being used, ignore sub-section 4.6.2.

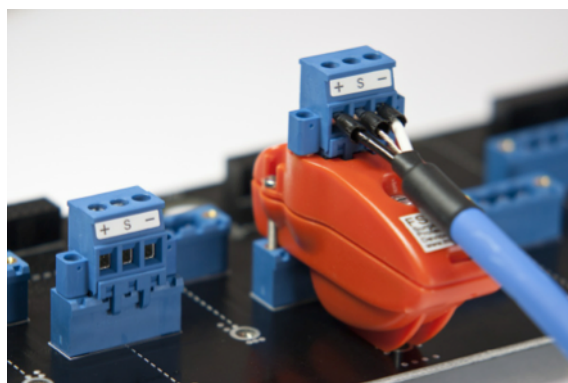

Figure 4.7 – FS32 Spur Surge module on carrier

4.6.1 Connecting the spur cables

Prepare the spur cables in accordance with the gland manufacturer's instructions and secure each cable in a suitable gland in the enclosure wall.

IMPORTANT

- When fitting the cable in the gland allow 20 – 30mm of additional cable length outside the enclosure to allow for adjustment if a Spur Surge module is taken out of circuit inside the enclosure. See Section 5.4.1 for further details
- Cable ferrules must be fitted to any stranded cable or screen wiring that is being used.
- Connect the prepared ends of the fieldbus spur cables into the '+', 'S' and '-' terminals on the carrier (or surge module, if fitted), making sure that the same polarity is observed for all spurs.

4.6.2 Fitting FS32 Spur Surge modules

Spur Surge modules are pluggable units that integrate easily with the standard pluggable connector and which direct excessive spur surge currents to the protective local ground.

To fit an FS32:

1. Unscrew the two captive screws securing the standard pluggable connector (supplied on the carrier) and remove it from its socket.
2. Insert the FS32 module into the now vacant socket on the carrier, tighten the two side securing screws and the central "protective ground" screw, to a recommended torque of 0.4 Nm.
3. Fit the connector (removed at Step 1 above) into the socket on the FS32 and tighten its two securing screws also to a recommended torque of 0.4 Nm.
4. Removal of a Spur Surge module is the reverse of the fitting process. See also Section 5.4.1 on page 14 for information on cable 'adjustment' if one of these modules is taken out of use.

4.7 Blanking Plugs.

Blanking plugs of factory-supplied Fieldbus Barriers are lightly tightened for ease of removal. Any blanking plugs that are not removed from the fieldbus barrier must be tightened to the required torque to meet the IP rating.

Two types of blanking plug are supplied with the Fieldbus Barrier as shown in figures 4.8 and 4.9 below and should be tightened to a torque rating as shown in the table below.

Type A	4.8Nm
Type B	12Nm



Figure 4.8 - Type A Blanking plug



Figure 4.9 - Type B Blanking plug

4.8 Final Checks.

Before replacing the lids on the enclosure, check:

- that all wire terminal connection screws have been tightened.
- that all cable glands are tightened to provide the required IP seal in accordance with gland installation instructions.
- that there are no loose cable ends that could cause an open or short circuit.
- that the protective trunk wiring cover is in place on the Trunk Terminal Assembly.
- that no tools (e.g. screwdrivers) or loose items have been left in the enclosure.
- that there is no damage to any cover seal, otherwise it must be replaced with one that has the same manufacturer's part number.
- that if, and only if, the enclosure is the last one on the fieldbus segment, that a 9378-FT Terminator module is fitted into the socket on the TTA.
- that the required grounding link is securely connected between the enclosure lid and the enclosure body.

Fit the enclosure lid and tighten all of its securing screws to a recommended torque of 2.5 Nm.

5 MAINTENANCE

When the enclosure is installed in a hazardous area it is important for personnel to understand what activities are permissible when fieldbus power is present and what are not.



WARNING !

Read and understand what work is permitted inside the enclosure. Failure to comply with these instructions can endanger the lives or health of personnel and risk damage to the plant and the environment.

5.1 General

The following items in the enclosure may be removed or disconnected while the trunk is still powered.

- 9377-FB-R Fieldbus Barrier module(s)
- 9376-SP Trunk Surge module
- FS32 Spur Surge modules and any spur wiring

All other wiring in the enclosure requires the trunk power to be isolated, or a gas clearance certificate to be obtained before any work is carried out.

5.2 Fieldbus Barrier - fitting and removal

CAUTION!

THESE ENCLOSURES ARE SUPPLIED WITH FIELDBUS BARRIER MODULE TYPE 9377-FB-R

IT IS NOT POSSIBLE TO FIT THE EARLIER BARRIER TYPE (MODEL 9377-FB) INTO THESE ENCLOSURES.

The individual 9377-FB-R Redundant Fieldbus Barrier module(s) may be fitted or removed without isolating the trunk power. The trunk connections to the barrier module on the carrier have spark suppression by design and cannot cause ignition while they are being connected or disconnected.

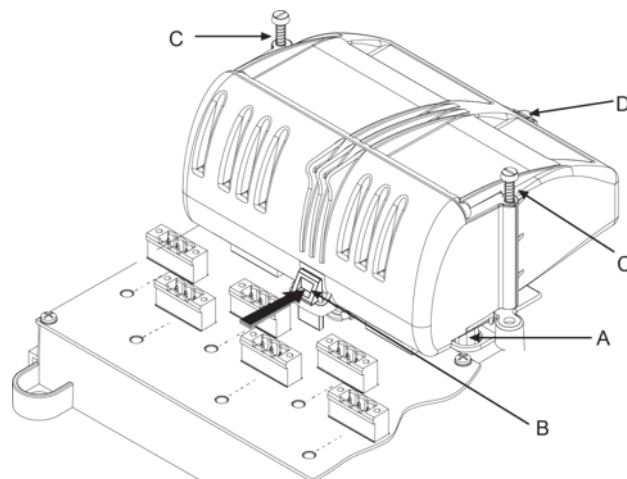

Figure 5.1 – Fieldbus Barrier module – fitting & removal

5.2.1 Removing a Fieldbus Barrier module (refer to Figure 5.1)

- a) Loosen the three captive fixing screws (C & D) on the module to release it. The screws are all spring-loaded and should retract when the thread has disengaged.
- b) Slowly pull the 9377-FB-R Fieldbus Barrier module away from its connections on the carrier until the safety retaining clip (B) stops further removal.
- c) Press the clip (see bold black arrow) towards the module until the barrier is released and can be removed completely.

5.2.1.1 Fitting a Fieldbus Barrier module (refer to Figure 5.1)

Note: Before fitting a 9377-FB-R Fieldbus Barrier module check the connection pins on its underside to ensure that they have not been bent or damaged in any way.

Do not use, or attempt to repair, a barrier module that has any of its pins bent or damaged, because this might affect its safety and will invalidate the certification.

- a) Engage the locating guides (A) of the 9377-FB-R Fieldbus Barrier module into the sockets provided on the carrier and push the module fully into place.
- b) Tighten the three captive fixing screws (C & D) to a recommended torque of 0.9Nm to secure it.

5.3 Trunk Surge Protection module

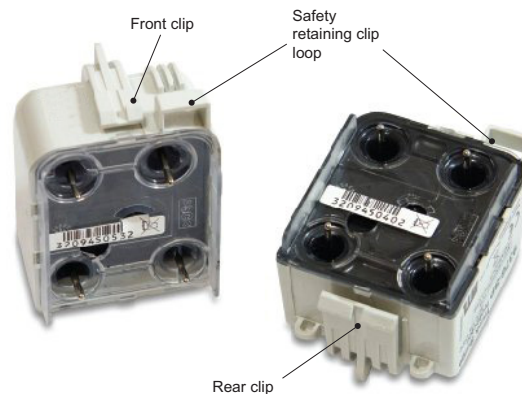

Figure 5.2 –Trunk Surge Module connectors and retaining clips

5.3.1 Fitting and removal

The module has connectors that are designed to prevent an ignition-capable spark when the module is installed or removed.

Do not use, or attempt to repair, a module that has any of the pins on its underside bent or damaged, because this might affect its safety and invalidate the certification.



Figure 5.3 – Fitting and removal of Trunk Surge Module

5.3.1.1 Mounting a module

Refer to Figure 5.3.

Orientate the module so that the smaller front clip is facing the trunk terminals, then:

- push the module so that the safety retaining clip on the carrier housing fits into the loop on the module
- locate the terminal pins into their contact sockets on the carrier housing and
- push the module home until front and rear retaining clips engage.

5.3.1.2 Removing a module

Refer to Figures 5.2 and 5.3 for further information.

Removal is a two-step process that first breaks the electrical connection, followed by the physical removal of the module from the housing.

- Press the clip at the top of the module and tilt the module forward until the clip disengages at the rear
- Press the front clip and withdraw the module from its socket until it is stopped by the safety retaining clip
- Press down on the safety retaining clip enough to release it, then pull the module away from the carrier housing without rotating or twisting it.

5.4 Spur connections

All of the spur connections are intrinsically safe and therefore may be live-worked in a hazardous area without 'gas clearance', while complying with normal 'permit to work' procedures.

If spur wiring is removed from a connecting plug, ensure that the same polarity is observed when it is reconnected.

5.4.1 Removing a Spur Surge module & spur cable adjustment

If an FS32 Spur Surge module needs to be removed from circuit, it will probably be necessary to increase the cable length inside the enclosure slightly to allow the spur wiring connector to be plugged into the circuit board. Use the following procedure.

- a) Loosen the two screws securing the pluggable, spur-wiring connector to the Spur Surge module and unplug it.
- b) Loosen all three of the Spur Surge module's fixing screws and unplug it from the carrier.
- c) Loosen the spur cable gland.
- d) Pull an additional 20 mm (approx.) of additional cable length into the enclosure.
- e) Plug the spur connecting plug into its mating socket on the barrier carrier and tighten the fixing screws to a recommended torque value of 0.4 Nm.

Make any final adjustments to the cable, to avoid any tension, then tighten the spur cable gland to clamp the cable to retain the IP rating of the enclosure.

5.4.2 Adding a Spur Surge module & spur cable adjustment

If an FS32 Spur Surge module is added, it will probably be necessary to reduce the cable length inside the enclosure slightly when connecting the spur wiring connector to the Spur Surge module. Refer also to Section 4.6.1 for further fitting details.

- a) Loosen the two screws securing the pluggable, spur-wiring connector to the carrier and unplug it.
- b) Plug the Spur Surge module into the vacant socket on the carrier and tighten the two fixing screws and its grounding screw, all to a recommended torque of 0.4 Nm.
- c) Loosen the spur cable gland.
- d) Withdraw approximately 20 mm of the cable length from the enclosure.
- e) Plug the spur connecting plug into its mating socket on the Spur Surge module and tighten the fixing screws to a recommended torque of 0.4 Nm.

Make any final adjustments to the cable, to avoid any tension then tighten the spur cable gland to clamp the cable to retain the IP rating of the enclosure.

5.5 Trunk connections

	<p>WARNING !</p> <p>No part of the Trunk Terminal Assembly may be worked while the enclosure is powered, unless the environment is known to be non-hazardous.</p>
---	--

Before any work starts on the Trunk Terminal Assembly the trunk power to the enclosure must be isolated, or a gas clearance certificate obtained.

Once the conditions are known to be safe, the protective plastic cover of the Trunk Terminal area may be removed.

Refer to Section 4.2.1 for additional information about trunk wiring connections.

When any changes or checks have been carried out, ensure there are no loose implements left inside the Trunk Terminal area before replacing its protective cover.

5.6 Regular Maintenance checks

Check the general condition of the installation occasionally to ensure that no deterioration has occurred. At least every two years (and more frequently for harsh, dusty or dirty environments) check:

- the condition of all wire connections/terminations/screens.
- that all of the fixing and cover screws and blanking plugs are secure and the breather is clear.
- that there are no signs of damage or corrosion.
- that the level of accumulated dust on the enclosure does not exceed 5mm.

	<p>WARNING !</p> <p>If the outer enclosure of the apparatus needs to be cleaned, this should be done with a non-electrostatic generating cloth lightly moistened by a dilute mixture of detergent in water.</p>
---	--

In addition, take advantage of plant maintenance shutdown periods or **whenever the area is known to be non-hazardous**, to check wiring quality by confirming that the dc voltage on the fieldbus trunk, when measured at the enclosure, is >16V. This can be performed using a multimeter or an FBT-6 fieldbus tester.

6 TROUBLESHOOTING

The Fieldbus Barriers inside the enclosure are fitted with LED indicators to assist the user in fault identification. Consult the following tables to understand the meaning of the LED states.

Power LED (Green)

ON	OFF
Trunk power applied	Insufficient or no trunk power

CAUTION!

THE POWER LED WILL NOT LIGHT UNTIL THE VOLTAGE AT THE BARRIER HAS RISEN TO A VALUE OF AT LEAST 15.7V, BUT COULD REMAIN LIT EVEN AFTER THE VOLTAGE HAS DROPPED TO AROUND 13.0V. DO NOT ASSUME THE POWER LED INDICATES A VOLTAGE OF 16V OR MORE.

If the green Power LED is not lit, check:

- the polarity and integrity of the trunk cable connections to the enclosure.
- that the d.c. supply powering the incoming trunk is operating correctly.

Spur LEDs

ON	ON	ON
Green	Steady	Channel powering spur, spur OK
Green	Flashing*	Channel powering spur but spur open circuit
Red	Steady	Short to shield on one or more spurs
Orange	Flashing*	Spur short circuit, or spur in current limit state

* Flashing occurs at a rate of approximately 2 pulses per second.

CAUTION!

937X-FB2 FIELDBUS BARRIER ENCLOSURES ARE DESIGNED TO OPERATE RELIABLY IN INDUSTRIAL ENVIRONMENTS AND COMPLY WITH INTERNATIONAL STANDARDS FOR IMMUNITY TO ELECTROMAGNETIC RADIATION. HOWEVER, DAMAGE MAY OCCUR IF THE APPARATUS IS EXPOSED TO EXTREME LEVELS OF RADIATED ELECTRICAL NOISE, FOR EXAMPLE FROM "WALKIE-TALKIE" RADIOS, OR ELECTRIC ARC-WELDING. IF LOCAL WELDING ACTIVITY IS UNAVOIDABLE, POWER SHOULD FIRST BE REMOVED FROM THE FIELDBUS BARRIER.

7 ATEX/IECEx information

The Essential Health and Safety Requirements (Annex II) of the EU Directive 2014/34/EU [the ATEX Directive- safety of apparatus] requires that the installation manual of all equipment used in hazardous areas shall contain certain information. This annex is included to ensure that this requirement is met. It complements the information presented in this document and does not conflict with that information. It is only relevant to those locations where the ATEX directives are applicable.

7.1 General

- a) In common with all other electrical apparatus installed in hazardous areas, this apparatus must only be installed, operated and maintained by competent personnel. Such personnel shall have undergone training, which included instruction on the various types of protection and installation practices, the relevant rules and regulations, and on the general principles of area classification. Appropriate refresher training shall be given on a regular basis. [See clause 4.2 of IEC/EN 60079-17].
- a) The apparatus has been designed and manufactured so as to provide protection against all the relevant additional hazards referred to in Annex II of the Directive, such as those in clause 1.2.7.
- b) This apparatus has been designed to meet the requirements of electrical apparatus in accordance with IEC/EN 60079-0, IEC/EN 60079-1, IEC/EN 60079-7, IEC/EN 60079-11, IEC/EN 60079-18 and IEC/EN 60079-31.

7.2 Installation

- a) The installation should comply with the appropriate European, national and local regulations, which may include reference to the code of practice IEC/EN 60079-14. In addition particular industries or end users may have specific requirements relating to the safety of their installations and these requirements should also be met. For the majority of installations the Directive 1999/92/EC [the ATEX Directive- safety of installations] is also applicable.
- b) The enclosures are certified:
ⓈII 2(1) GD
Ex db eb ib mb [ia Ga] IIC T4 Gb
Ex tb IIIC T80°C Db
(-40°C ≤ Ta ≤ +70°C)
and are designed for installation in Zone 1 and Zone 2 hazardous areas.
- c) The apparatus must not be subjected to mechanical and thermal stresses in excess of those permitted in the certification documentation, this manual and the product specification.
- d) All cables and their glands must be chosen to withstand the temperatures at which the apparatus is designed to operate. See product specification for details.
- e) The apparatus must not be installed in a position where it may be attacked by aggressive substances.
- f) All empty enclosure holes must be fitted with:
 - 1. ≥IP66 Ex eb tb Equipment certified blanking plugs or ≥IP66 Ex eb tb Equipment certified cable glands. All blanking plugs and glands must have a minimum temperature range (-40°C to +75°C).
 - 2. ≥IP66 Ex eb tb breather IECEx & ATEX equipment certified with a minimum temperature range of -40°C to +75°C and IP rating (IP66) at least equal to that of the enclosure.

Read also the Special Conditions for Safe Use (below) for any additional or more specific information.

Special Conditions for Safe Use

1. The equipment shall only be powered from supplies conforming to IEC 61158.
2. When a Trunk Surge Module is fitted, the power input circuit will not withstand a 500V a.c. isolation test to earth. This must be taken into account during installation.
3. When one or more Spur Surge Modules are fitted, the spur outputs will not withstand a 500V a.c. isolation test to earth. This must be taken into account during installation.
4. Potential electrostatic hazard. The equipment should be cleaned only with a damp cloth.
5. When the enclosure is fitted with a hinged lid, it shall only be mounted in a vertical orientation on a flat surface, and care is required in the installation process and when opening the hinged lid to ensure the enclosure does not distort.
6. When the enclosure is fitted with a fully bolted lid the enclosure may be mounted in any orientation but it shall be on a flat surface and care is required in the installation process to ensure that the enclosure does not distort.
7. All cable glands and stopper plugs used for cable entries shall be suitably certified and shall have a minimum Degree of Ingress Protection of IP66.
8. When using the 93ZX-FB2-XX-ST enclosure, plastic parts not assessed to requirements of IEC/EN 60079-0 CL 7.3 Resistance to Light, the equipment shall be marked by the symbol "X" to indicate this specific condition of use according to IEC/EN 60079-0 CL 29.3 item e) i.e. not subject to direct exposure to any natural or artificial light source such as lamps or lighting.

7.3 Inspection and maintenance

- a) Inspection and maintenance should be carried out in accordance with European, national and local regulations which may refer to the standard IEC/EN 60079-17.

In addition specific industries or end users may have specific requirements which should also be met.

- b) Care should be taken to limit dust accumulation on the exterior of the apparatus to a depth not exceeding 5mm.
- c) If the outer enclosure of the apparatus needs to be cleaned, this should be done with a non-electrostatic generating cloth lightly moistened by a dilute mixture of detergent in water.
- d) Maintenance of internal components while powered is limited to those actions permitted in Section 5 of this manual.

7.4 Repair

The modules used in this product cannot be repaired by the user and must be replaced with an equivalent certified product.

7.5 Marking

Each certified component is marked in compliance with the Directive and CE marked with the Notified Body Identification Number.

This information applies to products manufactured during or after the year 2014.

For full certification information visit www.mtl-inst.com/support/certificates/

Products labels (showing certification information)

Enclosure marking (Made in England)

EATON CROUSE-HINDS SERIES
9371-FB2
 MTL fieldbus barrier system, 6-spur stainless steel enclosure

Baseefa 14ATEX0112X FISCO Power supply (spurs)
 -40°C < Ta < +70°C

II 2(1) GD
 IECEx BAS 14.0058X
 Ex db eb lb mb [Ia Ga] IIC T4 Gb
 Ex tb IIIC T80°C Db

现场总线隔离栅

WARNING:-
 NON-INTRINSICALLY SAFE CIRCUITS PROTECTED BY INTERNAL IP30 COVER.
 ELECTROSTATIC HAZARD CLEAN ONLY WITH A MOIST CLOTH AND DETERGENT.

警告
 非本安电路由内部IP30等级结构保护。
 危险只能用湿布清洁剂清洁。

SEE INSTRUCTION MANUAL
 参考使用说明书

EU Importer – Eaton, 69412 Eberbach, Germany
 EATON ELECTRIC LTD, Luton, England, LU2 8DL.
 Made in England. www.mtl-inst.com

CE 0598 30

EATON CROUSE-HINDS SERIES
9373-FB2
 MTL fieldbus barrier system, 12-spur stainless steel enclosure

Baseefa 14ATEX0112X FISCO Power supply (spurs)
 -40°C < Ta < +70°C

II 2(1) GD
 IECEx BAS 14.0058X
 Ex db eb lb mb [Ia Ga] IIC T4 Gb
 Ex tb IIIC T80°C Db

现场总线隔离栅

WARNING:-
 NON-INTRINSICALLY SAFE CIRCUITS PROTECTED BY INTERNAL IP30 COVER.
 ELECTROSTATIC HAZARD CLEAN ONLY WITH A MOIST CLOTH AND DETERGENT.

警告
 非本安电路由内部IP30等级结构保护。
 危险只能用湿布清洁剂清洁。

SEE INSTRUCTION MANUAL
 参考使用说明书

EU Importer – Eaton, 69412 Eberbach, Germany
 EATON ELECTRIC LTD, Luton, England, LU2 8DL.
 Made in England. www.mtl-inst.com

CE 0598 30

Enclosure marking (Made in India)

EATON CROUSE-HINDS SERIES
9371-FB2
 MTL fieldbus barrier system, 6-spur stainless steel enclosure

Baseefa 14ATEX0112X FISCO Power supply (spurs)
 -40°C < Ta < +70°C

II 2(1) GD
 IECEx BAS 14.0058X
 Ex db eb lb mb [Ia Ga] IIC T4 Gb
 Ex tb IIIC T80°C Db

WARNING:-
 NON-INTRINSICALLY SAFE CIRCUITS PROTECTED BY INTERNAL IP30 COVER.
 ELECTROSTATIC HAZARD CLEAN ONLY WITH A MOIST CLOTH AND DETERGENT.

SEE INSTRUCTION MANUAL

EU Importer – Eaton, 69412 Eberbach, Germany
 EATON ELECTRIC LTD, Luton, England, LU2 8DL.
 Made in India. www.mtl-inst.com

CE 0598 30

EATON CROUSE-HINDS SERIES
9373-FB2
 MTL fieldbus barrier system, 12-spur stainless steel enclosure

Baseefa 14ATEX0112X FISCO Power supply (spurs)
 -40°C < Ta < +70°C

II 2(1) GD
 IECEx BAS 14.0058X
 Ex db eb lb mb [Ia Ga] IIC T4 Gb
 Ex tb IIIC T80°C Db

WARNING:-
 NON-INTRINSICALLY SAFE CIRCUITS PROTECTED BY INTERNAL IP30 COVER.
 ELECTROSTATIC HAZARD CLEAN ONLY WITH A MOIST CLOTH AND DETERGENT.

SEE INSTRUCTION MANUAL

EU Importer – Eaton, 69412 Eberbach, Germany
 EATON ELECTRIC LTD, Luton, England, LU2 8DL.
 Made in India. www.mtl-inst.com

CE 0598 30

Module Carrier marking

EATON CROUSE-HINDS SERIES
 MTL FB2 MODULE CARRIER

II 2 (1) G -40°C < Ta < +75°C
 Part of Certificates
 IECEx BAS14.0057U
 FISCO Power Supply (Spurs) Baseefa 14ATEX0111U

EU Importer – Eaton, 69412 Eberbach, Germany
 EATON ELECTRIC LTD, Luton, England, LU2 8DL. Made in England

CE 0598 30

EATON CROUSE-HINDS SERIES
 MTL FB2 MODULE CARRIER

II 2 (1) G -40°C < Ta < +75°C
 Part of Certificates
 IECEx BAS14.0057U
 FISCO Power Supply (Spurs) Baseefa 14ATEX0111U

EU Importer – Eaton, 69412 Eberbach, Germany
 EATON ELECTRIC LTD, Luton, England, LU2 8DL. Made in India

CE 0598 30

Barrier Marking

EATON CROUSE-HINDS SERIES
9377-FB-R MTL fieldbus barrier module, 6-spur
 -40°C < Ta < +75°C

FOUNDATION

FOR CERTIFICATION DETAILS REFER TO MODULE CARRIER LABEL

EU Importer - Eaton, 69412 Eberbach, Germany
 EATON ELECTRIC LTD, Luton, England,
 LU2 8DL. Made in England. www.mtl-inst.com

CE 0598 30

Trunk surge protector marking

EATON CROUSE-HINDS SERIES
9376-SP MTL trunk surge protector
 -40°C < Ta < +75°C

Baseefa 09ATEX0324U
 II 2G Ex db eb mb IIC Gb
 IECEx BAS10.0005U

EU Importer - Eaton,
 69412 Eberbach, Germany
 EATON ELECTRIC LTD
 Luton, England, LU2 8DL. Made in India

CE 0598 30

Terminator marking

Baseefa 14ATEX0117U
 IECEx BAS14.0060U

UK CA 30

EATON, LU2 8DL
 England

THIS PAGE IS LEFT INTENTIONALLY BLANK

THIS PAGE IS LEFT INTENTIONALLY BLANK

CROUSE-HINDS
SERIES

EATON Crouse-Hinds series

The safety you rely on.

See the complete MTL product portfolio at www.eaton.com

For more information:

If further assistance is required, please contact an authorised MTL Distributor, Sales Office, or Customer Service Department

<https://www.mtl-inst.com/contact>

Eaton Electric Ltd

Great Marlings, Butterfield, Luton
Beds LU2 8DL

Tel: +44 (0) 1582 723633 Fax: +44 (0)1582 422283

E-mail: mtlenquiry@eaton.com

www.eaton.com



Eaton Electric Limited,

Great Marlings, Butterfield, Luton
Beds, LU2 8DL, UK.
Tel: + 44 (0)1582 723633 Fax: + 44 (0)1582 422283
E-mail: mtlenquiry@eaton.com
www.eaton.com

© 2025 Eaton
All Rights Reserved
Publication No. INM 937x-FB2-Px-SS Rev 3 091025
October 2025

EUROPE (EMEA):
+44 (0)1582 723633
mtlenquiry@eaton.com

THE AMERICAS:
+1 800 835 7075
mtl-us-info@eaton.com

ASIA-PACIFIC:
+65 6645 9864 / 6645 9865
sales.mtlsing@eaton.com

The given data is only intended as a product description and should not be regarded as a legal warranty of properties or guarantee. In the interest of further technical developments, we reserve the right to make design changes.