

- Latest generation LED light source
- 150 and 250lm output flux
- 3h duration
- Compact dimensions: 290x110x40mm

Light Source:

LED strip

Material:

Base and reflector white polycarbonate

Diffuser clear polycarbonate

Protection degree IP40 and IP65 with the accessory kit

Operation:

Maintained and Non-Maintained mode on all version

Fixed 60lm output in Maintained mode for all variants for high energy saving

3h duration

24h recharge period

Applications:

Schools, universities, commercial centers, stores, offices, public administration and all indoor generic environments

Safety antipanic lighting and escape route lighting

Exit sign with single and double side signalization

Thanks to the latest generation LED light source NexiLite is able to provide an high output flux up to 250lm.

With his compact and modern design, NexiLite can be used in any architectural context, the wide range of accessories allows installation on a wall, ceiling, surface or recessed in indoor and outdoor environments, thanks to IP65 protection kit.

The quality of the raw materials, the high technology of the electronic circuitry, together with the latest generation light sources put make it unique for performance and reliability.

NexiLite is available in non maintained NM and maintained M mode with 3 hours duration.

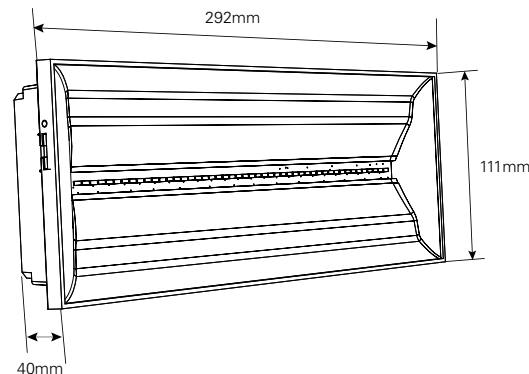

The right accessory at the right time

NexiLite is equipped with a wide range of accessories to meet any installation requirement.

The standard versions, with degree of protection IP40 are suitable to be installed indoors, but thanks to the IP65 kit are transformed into outdoor luminaires for use in wet and dusty environments.

For escape sign lighting, NexiLite is equipped with a series of single side pictograms and double side panels in accordance with International Standard ISO7010 with visibility distance of 20 and 30m (EN1838).

NexiLite's single side pictograms are different from those adhesives commonly used since are positioned between the reflector and the diffuser, are free of glue and can be repositioned as desired without the formation of unsightly defects.



NexiLite LED with IP65 protection kit

The IP65 kit is compatible with all the variants.
Only surface mounting. Dimension 308x125x53 mm



With double-side pictograms



Viewing distance: 30m

With single-side pictograms



Nexi pictograms don't stick, but are placed behind transparent diffuser.

Viewing distance: 20m





Recessed base for bricks wall



Order code: NEXI-RB
Cut-out: 277x100 mm

Nexi LED frame







| Order code | Description |  |  |  |  |  |
|------------|---------------------|---|---|--|---|---|
| NXL150-3H | NexiLite 150Lm 3h M | 3.1 W | 150 Lm | 3h | 3.6V - 2.0Ah NiCd | Maintained / Non-Maintained |
| NXL250-3H | NexiLite 250Lm 3h M | 3.6 W | 250 Lm | 3h | 7.2V - 1.7Ah NiCd | Maintained / Non-Maintained |

Accessories

| | |
|---------|---|
| NEXI-IP | IP65 protection kit |
| NEXI-RB | Bricks wall recessed base (cut-out 277x100mm) |
| NEXI-FC | False ceiling adapter (cut-out 272x95mm) |
| NEXI-FR | Finishing frame NexiTech LED |



Single-side pictograms

| | | |
|--------------|-------------------------------------|---|
| NEXI-PICTO-D | Pictogram Down ISO single-side 20m |  |
| NEXI-PICTO-L | Pictogram Left ISO single-side 20m |  |
| NEXI-PICTO-R | Pictogram Right ISO single-side 20m |  |
| NEXI-PICTO-U | Pictogram Up ISO single-side 20m |  |

Please see NexiTech for spacing table.

Double-side panels

Ultra version - high uniformity - compatible IP40 housing

| | | |
|--------------|--------------------------------------|---|
| NEXI-PLEX-DD | Double side panel Down/Down ISO 30m |  |
| NEXI-PLEX-LR | Double side panel Left/Right ISO 30m |  |
| NEXI-PLEX-DB | Double side panel Down/Blind ISO 30m |  |
| NEXI-PLEX-UU | Double side panel Up/Up ISO 30m |  |
| NEXI-PLEX-UB | Double side panel Up/Blind ISO 30m |  |

Lite version - standard uniformity - compatible IP65 housing & NEXI-IP kit

| | |
|--------------|---|
| NEXI-PLEX-IP | Double side panel NexiTech/NexiLite IP65 - ISO 30m delivered with 7 adhesive exit legends for single or double side |
|--------------|---|