

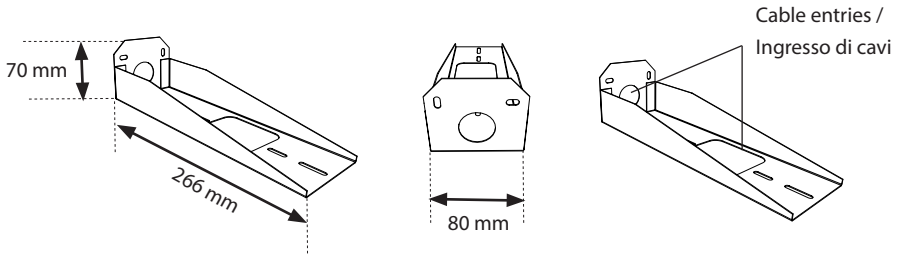

90° bracket for Emergency Luminaires

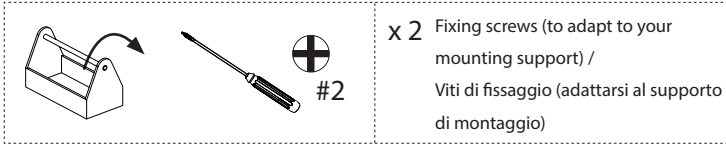

1

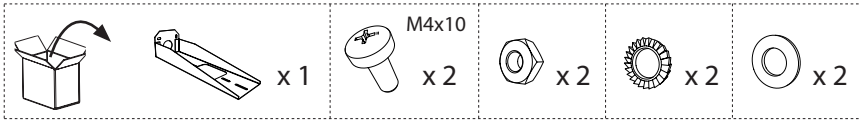
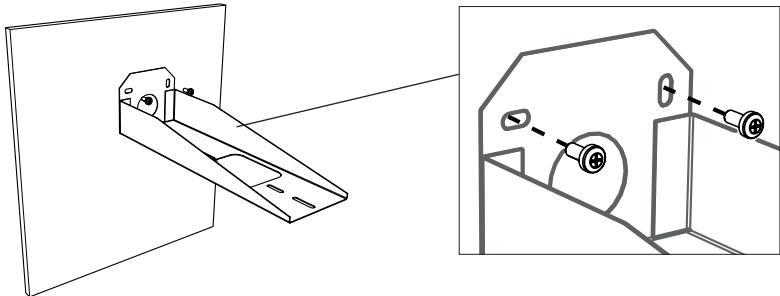

2

- a**  For SafeLite products, make sure that the product label is still visible when installed. /
Per i prodotti SafeLite, assicurarsi che l'etichetta del prodotto sia ancora visibile al momento dell'installazione.

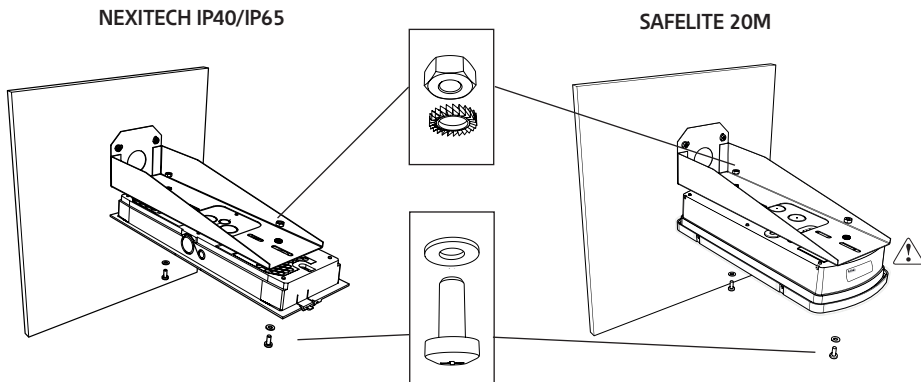

- b** Follow the wiring step of your luminaire manual. /
Segui la fase di cablaggio del manuale del prodotto.

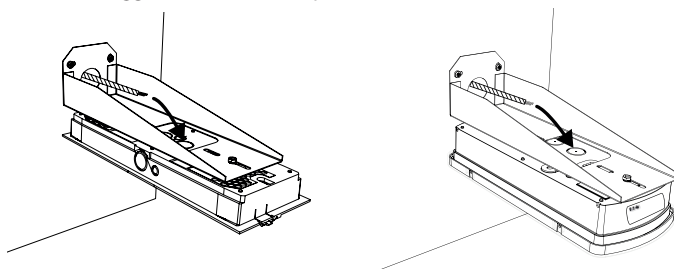

- c** See your luminaire manual for completing the installation of the luminaire. /
Consultare il manuale del prodotto per completare l'installazione.

Eaton
Cooper CSA srl
Via San Bovio, 3
20090 Segrate (MI) – ITALIA
Tel. +39 02 0959501
www.coopercsa.it/nexitechled
www.eaton.it

ZNO2045800 A - 10/2018

© 2018 Eaton
All Rights Reserved.

Eaton
Cooper Sécurité SAS
PEER II - Rue Beethoven - BP10184
63204 RIOM CEDEX FRANCE
Phone: +33 (0) 825 826 212
www.cooperfrance.com
www.eaton.com

Eaton is a registered trademark.

All trademarks are property
of their respective owners.



EATON

Powering Business Worldwide

Eaton.com/recycling
WEEE : contact your local dealer