

The safety you rely on.

Introducing Crouse-Hinds by Eaton

The leader in electrical products for hazardous, industrial and commercial applications worldwide.



Crouse-Hinds
by **EATON**



The safety you rely on.

Delivering world-class reliability and safety in high consequence harsh and hazardous environments

Only Eaton's Crouse-Hinds Business can deliver...

- Protection and safety of people and assets around the world with unsurpassed reliability and quality in every product we offer
- Industry-leading innovation and product efficiency
- Product solutions designed and certified for global specifications
- Best-in-class, global sales and customer service teams that provide local support

The Eaton advantage.



Crouse-Hinds remains the brand that stands for safety in the harshest of environments when power management is most critical. While it all began with the Condulet®, the Crouse-Hinds brand has grown into the premier name for a comprehensive portfolio of solutions for high consequence harsh and hazardous environments.

And now, the next phase in the evolution of the brand you trust: Crouse-Hinds joins the leading Eaton portfolio of reliable, efficient and safe electrical power management solutions.

More protection. More technology. Expect more.

Crouse-Hinds
by **EAT•N**



Contents

About Us 4-5

Cable Glands & Thread Conversion Products for Hazardous Areas

Selection Guide for Hazardous Areas.....8-9
 Selection Guide for Non-hazardous Areas..... 10-11
 Capri ADE Cable Glands Specification Features . 12-13
 Capri ADE 1F214-15
 Capri ADE 1F2 DS.....16-17
 Capri ADE 1F2 with Integral Clamping Module... 18-19
 Capri ADE 1FC20-21
 Capri ADE 4F.....22-23
 Capri ADE 5F..... 24-25
 Capri ADE 6F.....26-27
 Capri ADE 6FC28-29
 Capri ADE Cable Gland Accessories & Kits..... 30
 Capri Accessories.....31-33
 Capri NEWCAP MS-e 34
 Capri NEWCAP CT-e 35
 Capri EXACAP Ex-e & Ex-i / CEAG GHG Ex-e & Ex-i ... 36
 CEAG Trumpet.....37
 Terminator™ II TMCX..... 38-39
 TMCX.....40
 TMC 41
 TECK 42
 Capri Ex Certified Reducers/Adapters..... 44
 Capri Ex Certified Stopping Plugs 45

Cable Glands & Thread Conversion Products for Non-hazardous Areas

Capri IGA2 48
 Capri IGBW 49
 Capri IGCW 50
 Capri IGCX..... 51
 Capri IGE1W..... 52
 Capri IGE1X..... 53
 Capri IGE2W..... 54
 Capri IGE2X..... 55
 Capri NEWCAP MS 56
 Capri NEWCAP MS Multi-wired/Flat 57
 Capri NEWCAP CT 58
 Capri ADE 4i..... 59
 Capri EUROCAP 60
 Capri ECP 61
 Capri UNICAP..... 62
 CGD..... 63
 CGB..... 64-65
 CGE..... 66
 Capri Industrial Accessories 67-74

Technical Information

Cable Glands Installation Guide..... 76-77
 Capri Cable Gland Certifications..... 78-79
 Capri ADE Ex Markings 80
 Crouse-Hinds Cable Gland Certifications 81
 Cable Types and Wiring Methods 82
 Selection of Cable Glands 83-85
 Bi-metallic Corrosion 86
 Thread Dimension Guide..... 87
 Ordering Using ADE Catalog Numbers 88-91

The product information published in our catalogs and literature is not guaranteed. It has been compiled with care and is sufficiently accurate for most purposes. It is subject to change without notice. Occasionally, it may be necessary to modify the materials, finishes or other components of the product. These changes will in no way reduce the performance or function for which the product is intended.

All statements, technical information and recommendations contained herein are based on information and tests we believe to be reliable. The accuracy or completeness thereof are not guaranteed. In accordance with Eaton's Crouse-Hinds' Terms and Conditions of Sale, and since conditions of use are outside our control, the purchaser should determine the suitability of the product for his/her intended use and assumes all risk and liability whatsoever in connection therewith.

All sales of Eaton's Crouse-Hinds products are specifically subject to the Terms and Conditions of Sale as shown in Eaton's Crouse-Hinds distributor price sheets.



Global Cable Glands Solution

Eaton's Crouse-Hinds Business provides a termination solution for virtually every cable type used in hazardous and industrial environments – both onshore and offshore and above and below ground. Our cable glands and accessory products are designed for strict adherence to global specifications for IEC and NEC wiring standards, meeting international and North American certification requirements including ATEX, IECEx, UL and regional certifications. Our products are also certified for dust and mining applications.

From the deserts of Africa to the icy waters of the North Sea, the world turns to Eaton's Crouse-Hinds Business for its complete range of cable installation products. Our cable glands, thread conversion products and cable installation accessories are used in industrial and commercial applications throughout the world, enhancing safety and productivity in the most severe environmental conditions.

Eaton's Crouse-Hinds Business cable glands are the easiest and safest solution for your installation and maintenance needs. In any electrical or instrumentation installation, our glands are the reliable and safe way to move power and signals.

Global Support & Manufacturing

Our sales support and manufacturing facilities are strategically positioned around the world to deliver products close to your project. Whenever required we are there on-site during construction, commissioning and training.

Eaton's Crouse-Hinds Business manufactures in five continents and sells into more than 100 countries. We have dedicated sales support in every major location with local technical sales and engineering teams to support your immediate needs. As one of the largest oil and gas bulk electrical and instrument material suppliers, we can easily provide you a single source for all the components to complete your project on time and on budget.

Crouse-Hinds
by **EATON**

A Powerful Transformation

Rely on the names you trust for the safety you need

The Capri and CEAG products you know are evolving. Our products, part of Eaton's Crouse-Hinds portfolio, are now united with Eaton's leading range of reliable, efficient and safe electrical power management solutions. Combined, we provide the world's largest portfolio of electrical equipment for explosive, classified and industrial areas.

With unsurpassed product reliability and quality, industry-leading innovation and product efficiency, and products designed and certified for global specifications, Eaton's Crouse-Hinds' solutions, including Capri and CEAG products, deliver proven solutions for harsh and hazardous environments.

Capri and CEAG have a new look as Crouse-Hinds by Eaton, but the products and technology you trust remain unchanged. From explosionproof panelboards and lighting to connectivity and cable glands, the broadest offering of solutions for harsh and hazardous environments is now available from Crouse-Hinds by Eaton.

**More protection. More technology.
Expect more.**





Cable Glands & Thread Conversion Products for Hazardous Areas

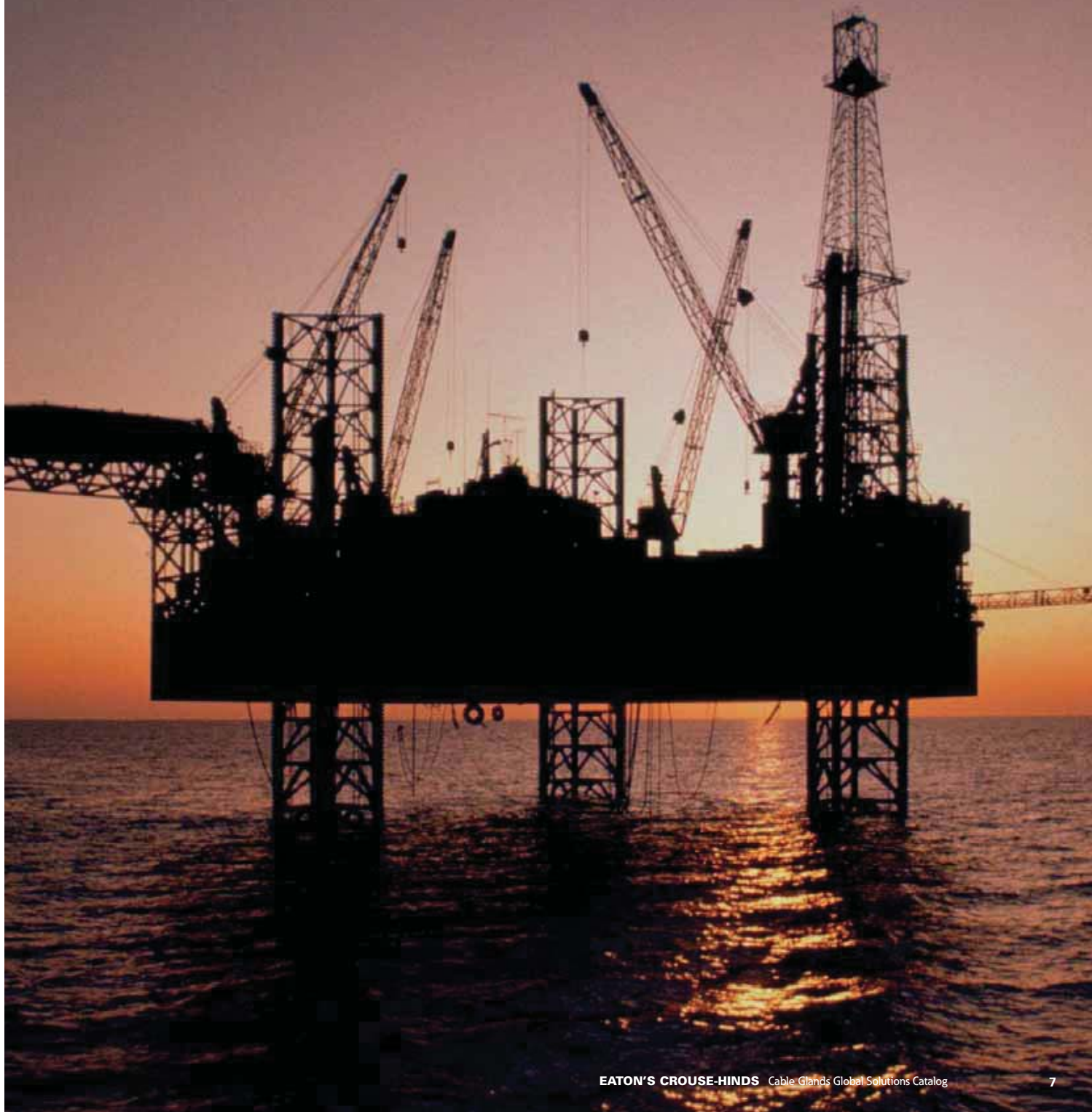







Selection Guide for Cable Glands for Hazardous Areas

CABLE GLAND		CABLE TYPE	GLAND TYPE	STANDARD MATERIAL	CERTIFICATION
NEWCAP CT-e Page 35		<ul style="list-style-type: none"> • Non-armoured • Braided cable for EMC specific cable and application 	<ul style="list-style-type: none"> • Non-armoured 	<ul style="list-style-type: none"> • Nickel-plated brass • Option: <ul style="list-style-type: none"> • Stainless steel 	
EXACAP Ex-e Page 36		<ul style="list-style-type: none"> • Non-armoured 	<ul style="list-style-type: none"> • Non-armoured 	<ul style="list-style-type: none"> • Nylon 	
EXACAP Ex-i Page 36		<ul style="list-style-type: none"> • Non-armoured 	<ul style="list-style-type: none"> • Non-armoured 	<ul style="list-style-type: none"> • Nylon 	
TRUMPET Page 37		<ul style="list-style-type: none"> • Non-armoured 	<ul style="list-style-type: none"> • Non-armoured 	<ul style="list-style-type: none"> • Nylon 	
TMCX II Pages 38-39		<ul style="list-style-type: none"> • Metal-clad with interlocked or continuously-welded corrugated • TECK armoured • Non-armoured • Tray cable 	<ul style="list-style-type: none"> • Armoured 	<ul style="list-style-type: none"> • Aluminum • Option: <ul style="list-style-type: none"> • Nickel-plated brass • Stainless steel 	
TMCX Page 40		<ul style="list-style-type: none"> • Metal-clad with interlocked or continuously-welded corrugated • TECK armoured • Non-armoured • Tray cable 	<ul style="list-style-type: none"> • Armoured barrier • Non-armoured barrier 	<ul style="list-style-type: none"> • Aluminum • Option: <ul style="list-style-type: none"> • Nickel-plated brass 	
TMC Page 41		<ul style="list-style-type: none"> • Metal-clad (interlocked or continuously welded corrugated armoured), non-armoured and tray cable 	<ul style="list-style-type: none"> • Armoured barrier 	<ul style="list-style-type: none"> • Aluminum 	
TECK Page 42		<ul style="list-style-type: none"> • TECK armoured 	<ul style="list-style-type: none"> • Non-armoured barrier 	<ul style="list-style-type: none"> • Aluminum • Option: <ul style="list-style-type: none"> • Stainless steel • Steel 	

Selection Guide for Cable Glands for Non-hazardous Areas

CABLE GLAND		CABLE TYPE	GLAND TYPE	STANDARD MATERIAL
IGA2 Page 48		<ul style="list-style-type: none"> • Non-armoured 	<ul style="list-style-type: none"> • Non-armoured 	<ul style="list-style-type: none"> • Brass • Option: <ul style="list-style-type: none"> • Nickel-plated
IGBW Page 49		<ul style="list-style-type: none"> • SWA 	<ul style="list-style-type: none"> • Armoured 	<ul style="list-style-type: none"> • Brass • Option: <ul style="list-style-type: none"> • Nickel-plated
IGCW Page 50		<ul style="list-style-type: none"> • SWA 	<ul style="list-style-type: none"> • Armoured 	<ul style="list-style-type: none"> • Brass • Option: <ul style="list-style-type: none"> • Nickel-plated
IGCX Page 51		<ul style="list-style-type: none"> • SWA 	<ul style="list-style-type: none"> • Armoured 	<ul style="list-style-type: none"> • Brass • Option: <ul style="list-style-type: none"> • Nickel-plated
IGE1W Page 52		<ul style="list-style-type: none"> • SWA • Lead sheathed 	<ul style="list-style-type: none"> • Armoured 	<ul style="list-style-type: none"> • Brass • Option: <ul style="list-style-type: none"> • Nickel-plated
IGE1X Page 53		<ul style="list-style-type: none"> • SWB • STA 	<ul style="list-style-type: none"> • Armoured 	<ul style="list-style-type: none"> • Brass • Option: <ul style="list-style-type: none"> • Nickel-plated
IGE2W Page 54		<ul style="list-style-type: none"> • SWB • STA 	<ul style="list-style-type: none"> • Armoured 	<ul style="list-style-type: none"> • Brass • Option: <ul style="list-style-type: none"> • Nickel-plated
IGE2X Page 55		<ul style="list-style-type: none"> • STA • Lead sheathed 	<ul style="list-style-type: none"> • Armoured 	<ul style="list-style-type: none"> • Brass • Option: <ul style="list-style-type: none"> • Nickel-plated

Selection Guide for Cable Glands for Non-hazardous Areas

CABLE GLAND		CABLE TYPE	GLAND TYPE	STANDARD MATERIAL	CERTIFICATION
NEWCAP MS Page 56		<ul style="list-style-type: none"> Non-armoured round Flexible braided cable 	<ul style="list-style-type: none"> Non-armoured 	<ul style="list-style-type: none"> Nickel-plated brass Option: <ul style="list-style-type: none"> Stainless steel 	
NEWCAP MS MULTI-WIRED/ FLAT Page 57		<ul style="list-style-type: none"> Multi-wired cable Flat cable 	<ul style="list-style-type: none"> Non-armoured 	<ul style="list-style-type: none"> Nickel-plated brass 	
NEWCAP CT Page 58		<ul style="list-style-type: none"> Braided round cable EMC shielded cable 	<ul style="list-style-type: none"> Non-armoured 	<ul style="list-style-type: none"> Nickel-plated brass 	
ADE 4i Page 59		<ul style="list-style-type: none"> SWA SWB STA 	<ul style="list-style-type: none"> Armoured 	<ul style="list-style-type: none"> Nickel-plated brass 	
EUROCAP Page 60		<ul style="list-style-type: none"> Non-armoured round 	<ul style="list-style-type: none"> Non-armoured 	<ul style="list-style-type: none"> Nylon 	
ECP Page 61		<ul style="list-style-type: none"> Non-armoured round 	<ul style="list-style-type: none"> Non-armoured 	<ul style="list-style-type: none"> Nylon 	
UNICAP Page 62		<ul style="list-style-type: none"> Non-armoured round 	<ul style="list-style-type: none"> Non-armoured 	<ul style="list-style-type: none"> Nylon 	
CGD Page 63		<ul style="list-style-type: none"> Non-armoured 	<ul style="list-style-type: none"> Non-armoured 	<ul style="list-style-type: none"> Iron alloy/steel 	
CGB Pages 64-65		<ul style="list-style-type: none"> Non-armoured and tray cable 	<ul style="list-style-type: none"> Non-armoured 	<ul style="list-style-type: none"> Iron alloy/steel (depending on form) Option: <ul style="list-style-type: none"> Aluminum 	
CGE Page 66		<ul style="list-style-type: none"> Non-armoured 	<ul style="list-style-type: none"> Non-armoured 	<ul style="list-style-type: none"> Iron alloy/steel 	

Capri ADE Cable Glands - Specification Features

Material Specification

Metallic Components

The Capri ADE range of cable glands is available in four different material types:

- Nickel-plated brass
- 316 stainless steel
- Aluminum
- Bronze

Nickel-plated Brass

Nickel-plated brass is used extensively throughout the oil and gas and petrochemical industries because it provides superior protection against corrosion and contamination under severe conditions and in the most extreme environments over equivalent natural brass products.

All nickel-plated brass components, both external and internal, are designed specifically to allow for a nickel-plated coating between 5 to 7 microns that ensures the critical tolerances can be maintained. The design tolerance of the components and the quality control of the plating process ensure a uniform coating which protects against the possibility of chipping, flaking and peeling under extreme conditions.

Seal Material

The seal material of the ADE range has been carefully formulated to achieve the optimized performance across a wide range of operating temperature conditions.

The ADE range of cable glands are available with seals of the following material types:

- **Neoprene** - for standard applications
- **Silicone** - for extended temperature performance



Operating Temperature Range

The ADE models are suitable for the following operating temperatures:

- Neoprene seals: -30°C to +80°C
- Silicone seals: -60°C to +140°C
- Barrier compound: -60°C to +80°C

Refer to individual product data sheets for specifications.

For UL marine, refer to certification pages 78-79.



Capri ADE Cable Glands - Specification Features

Cable Clamping Technology

Fig. 1 - External Cable Clamping

All ADE models are designed to accommodate an external clamping module which provides additional mechanical strength for strain relief.

Fig. 2 - Outer Sheath Cable Sealing

All ADE models utilize a gland specific seal design (Fig. 8) which, combined with the material formulation, ensures suitable sealing and ingress protection on the outer cable sheath.

Fig. 3 & 4 - Inner Sheath Cable Sealing

The ADE 4F and ADE 5F utilize the same proven seal design as for the outer sheath (Fig. 8), while the ADE 6F utilizes a diaphragm design seal to achieve the desired flame path protection.

Fig. 5 & 6 - Universal Clamping - Armoured Cable

The ADE 4F, ADE 5F and ADE 6F models all offer universal designs for all types of armoured cable. These include:

- Steel wire armoured (SWA) cable
- Steel tape armoured (STA) cable
- Steel wire braided (SWB) cable
- Braided marine shipboard cable
- Lead sheath armoured cable
- Type P cable

All designs achieve clamping and earth bonding of the armour for all armour types with no reversible components.

Fig. 7 - Lead Sheath Armour Cable

The ADE 4F and ADE 5F ranges are suitable for lead sheath armoured cable with the addition of a simple washer.

Fig. 8 - Specially Formulated Elastomer Seal

Ingress Protection

IP Rating

All ADE models incorporate an elastomeric dust cap to prevent dust and solid ingress prior to installation. IP66 protection is achieved through the thread-to-thread engagement. Additional protection up to IP68 can be achieved through the addition of a sealing washer or thread sealant.

Deluge Protection

All ADE models comply and are certified to the DTS-01 deluge certification.

The ADE 6F incorporates an additional deluge boot seal for enhanced deluge protection in marine/offshore environments.



Fig. 1

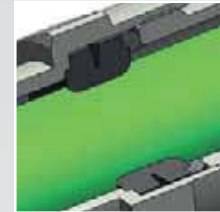

Fig. 2

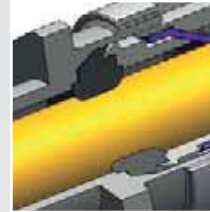

Fig. 3

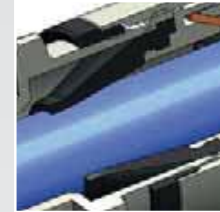

Fig. 4

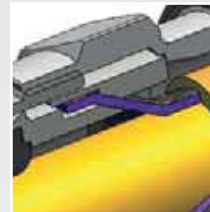

Fig. 5



Fig. 6



Fig. 7



Fig. 8

Capri ADE 1F2 - for Non-armoured Cable

Technical Specification



Suitable for the following cable types

- Non-armoured cable
- Marine shipboard cable; Type P cable

Certifications and Compliances

Zones 1 and 2, Groups IIA, IIB and IIC

Zones 21 and 22, Groups IIIA, IIIB and IIIC

ATEX Certificate No.: INERIS12ATEX0032X

Ex db IIC, Ex db I, Ex eb I, Ex eb IIC, Ex nRc IIC, Ex tb IIIC

IECEX Certificate No.: IECEX INE 12.0025X

Class I, Zone 1, AEx e II*

Class I, Zone 2, AEx e II, Ex e II

cULus Listed: E310130

Marine cULus Listed: E314047

*ADE sizes 3-8, 1/2" to 1 1/4" NPT or ISO 20 to 40
with TC-ER-HL unarmoured cable up to 1" diameter

DTS-01:91 Deluge Certification

Product Specification

Material:

Nickel-plated brass for superior corrosion resistance.
316 stainless steel, bronze and aluminum options available.
It is recommended that a suitable lubricant is used on all threads of stainless steel and aluminum versions.

Operating Temperature:

- Neoprene seal: -30°C to +80°C
- Silicone seal: -60°C to +140°C

Ingress Protection (IP)

Metric Threads:

Fitted on equipment with a flat surface, on threaded hole or on blank hole ("d" use excluded) fixed by a qualified locknut with all threads engaged:

- IP64 and IP66 without sealing washer and surface finish of Ra 0.4µm or on threaded hole and surface finish of Ra 1.6µm max.
- IP64 and IP66 with all sealing washers (red fiber, green fiber, neoprene, nylon or PTFE) on surface Ra 6.3µm max.
- IP68 tested 30m/7days with red fiber or green fiber sealing washers on surface Ra 6.3µm max.

NPT Threads:

- IP64, IP66 and IP68 tested 30m/7days, always fitted on equipment with threaded hole; HTL lubricant may be needed.

Clamping Technology

Elastomeric seal on cable outer sheath.

External cable clamping module (optional).



Features & Benefits

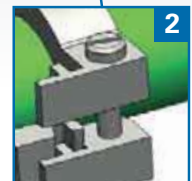
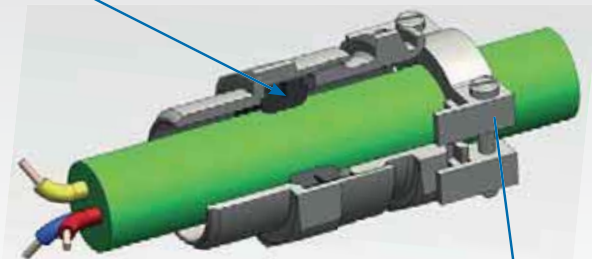
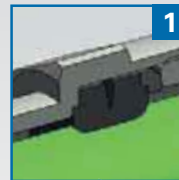

- 1: Specifically formulated elastomer for IP sealing on outer sheath of cable.
- 2: Additional external cable clamping for strain relief (optional).

Capri ADE 1F2 - Order Codes & Dimensions

Dimensions

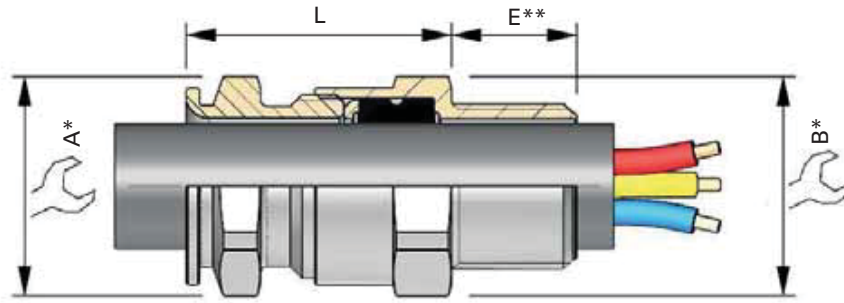

* For 'across corners' dimensions, multiply 'across flats' dimensions by 1.1

** For 'E' see Thread Dimension page 87

SERIES	THREAD SIZE	CABLE SEALING RANGE	MATERIAL	SEALING TYPE	OPTION
ADE1	M25	3	NP	N	

- 0 = XS
- 1 = S
- 2 = M
- 3 = L

SELECT

SELECT

SELECT

SELECT

VARIANT CODES	
K1	Accessories Kit 1
K2	Accessories Kit 2
K3	Accessories Kit 3
BLANK	No Option

N	Neoprene
S	Silicone

NP	Nickel-plated Brass
SS	Stainless Steel
BZ	Bronze
AL	Aluminum

KIT OPTIONS	
K1	Kit 1 Contents: • Locknut • Green Fiber Washer
K2	Kit 2 Contents: • Locknut • Green Fiber Washer • Earth Tag • Shroud
K3	Kit 3 Contents: • Locknut • Green Fiber Washer • Earth Tag • Serrated Washer

SELECTION TABLE						DIMENSIONS			GLAND SIZE	CATALOG NUMBER ISO	CATALOG NUMBER NPT	
SERIES	THREAD SIZE	THREAD SIZE CODE	THREAD SIZE	THREAD SIZE CODE	CABLE SEALING RANGE	CABLE SEALING RANGE ISO/(NPT)		L (LENGTH)				
						OUTER SHEATH MIN - MAX	A					B
ADE1	12*	M12	1/4"*	N025	3	4.5 - 8.0	17	17	25.0	4	ADE1M123NPN	ADE1N0253NPN
ADE1	16*	M16	3/8"*	N038	2	4.5 - 8.5	17	19	25.0	4	ADE1M162NPN	ADE1N0382NPN
ADE1	16*	M16	3/8"*	N038	3	7.0 - 12.0	19	19	27.5	5	ADE1M163NPN	ADE1N0383NPN
ADE1	20	M20	1/2"	N050	0	2.8 - 5.5	15	24	24.0	3	ADE1M200NPN	ADE1N0500NPN
ADE1	20	M20	1/2"	N050	1	4.5 - 8.5	17	24	25.0	4	ADE1M201NPN	ADE1N0501NPN
ADE1	20	M20	1/2"	N050	2	7.0 - 12.0	19	24	27.5	5	ADE1M202NPN	ADE1N0502NPN
ADE1	20	M20	1/2"	N050	3	10.0 - 16.0 (15.5)	24	24	32.0	6	ADE1M203NPN	ADE1N0503NPN
ADE1	25	M25	3/4"	N075	1	7.0 - 12.0	19	30	27.5	5	ADE1M251NPN	ADE1N0751NPN
ADE1	25	M25	3/4"	N075	2	10.0 - 16.0	24	30	32.0	6	ADE1M252NPN	ADE1N0752NPN
ADE1	25	M25	3/4"	N075	3	13.5 - 20.5	30	30	36.5	7	ADE1M253NPN	ADE1N0753NPN
ADE1	32	M32	1"	N100	3	18.0 - 27.5 (26.0)	41	41	46.0	8	ADE1M323NPN	ADE1N1003NPN
ADE1	40	M40	1 1/4"	N125	3	23.0 - 34.0	48	48	50.0	9	ADE1M403NPN	ADE1N1253NPN
ADE1	50	M50	1 1/2"	N150	1	29.0 - 41.0	55	55	52.0	10	ADE1M501NPN	ADE1N1501NPN
ADE1	50	M50	2"	N200	2	35.0 - 45.0 (48.0)	64	64	56.5	11	ADE1M502NPN	ADE1N2002NPN
ADE1	63	M63	2"	N200	3	42.0 - 56.0 (53.0)	72	72	60.0	12	ADE1M633NPN	ADE1N2003NPN
ADE1	75	M75	2 1/2"	N250	3	50.0 - 65.0 (62.5)	85	85	67.5	13	ADE1M753NPN	ADE1N2503NPN
ADE1	90	M90	3"	N300	2	58.0 - 74.0	95	95	69.0	14	ADE1M902NPN	ADE1N3002NPN
ADE1	90	M90	3"	N300	3	66.0 - 83.0 (78.0)	110	110	80.0	15	ADE1M903NPN	ADE1N3003NPN
ADE1	110	M110	3 1/2"	N350	2	75.0 - 93.0 (92.0)	120	120	80.0	16	ADE1M1102NPN	ADE1N3502NPN
ADE1	110	M110	4"	N400	3	85.0 - 104.0	135	135	90.0	17	ADE1M1103NPN	ADE1N4003NPN

* Not UL certified. All dimensions in mm. Above catalog numbers are for nickel-plated brass with neoprene seal; refer to order code diagram for other options.

If the material number (CAP) is required, please refer to pages 89-91.

Capri ADE 1F2 DS - (Double Seal) for Non-armoured Cable

Technical Specification



Suitable for the following cable types

- Non-armoured cable
- Marine shipboard cable; Type P cable

Certifications and Compliances

Zones 1 and 2, Groups IIA, IIB and IIC
Zones 21 and 22, Groups IIIA, IIIB and IIIC

ATEX Certificate No.: INERIS12ATEX0032X
II2GD / Ex db IIC / Ex eb IIC / Ex tb IIIC
II3G Ex nRc IIC, IM2 Ex db I Ex eb I

IECEX Certificate No.: IECEX INE 12.0025X

Class I, Zone 1, AEx e II*

Class I, Zone 2, AEx e II, Ex e II

cULus Listed: E310130

Marine cULus Listed: E314047

*ADE sizes 3-8, 1/2" to 1 1/4" NPT or ISO 20 to 40
with TC-ER-HL unarmoured cable up to 1" diameter

DTS-01:91 Deluge Certification

Product Specification

Material:

Nickel-plated brass for superior corrosion resistance.
316 stainless steel, bronze and aluminum options available.
It is recommended that a suitable lubricant is used on all threads of stainless steel and aluminum versions.

Operating Temperature:

- Neoprene seal: -30°C to +80°C
- Silicone seal: -60°C to +140°C

Ingress Protection (IP)

Metric Threads:

Fitted on equipment with a flat surface, on threaded hole or on blank hole ("d" use excluded) fixed by a qualified locknut with all threads engaged:

- IP64 and IP66 without sealing washer and surface finish of Ra 0.4µm or on threaded hole and surface finish of Ra 1.6µm max.
- IP64 and IP66 with all sealing washers (red fiber, green fiber, neoprene, nylon or PTFE) on surface Ra 6.3µm max.
- IP68 tested 30m/7days with red fiber or green fiber sealing washers on surface Ra 6.3µm max.

NPT Threads:

- IP64, IP66 and IP68 tested 30m/7days, always fitted on equipment with threaded hole; HTL lubricant may be needed.

Clamping Technology

Elastomeric seal on cable outer sheath.
External cable clamping module (optional).



Features & Benefits

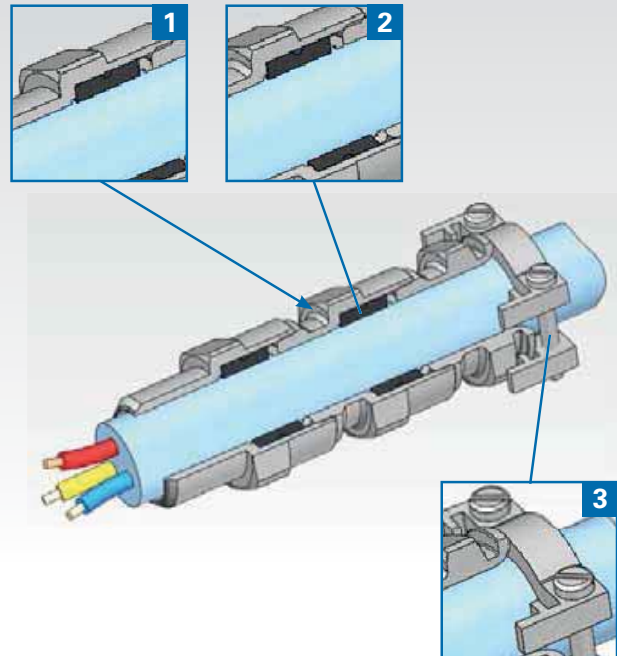

- 1: Flameproof and sealing on outer sheath of the cable.
- 2: Environmental sealing and controlled pulling resistance on outer sheath of the cable.
- 3: Additional clamping for strain relief (optional).

Capri ADE 1F2 DS - Order Codes & Dimensions

Dimensions

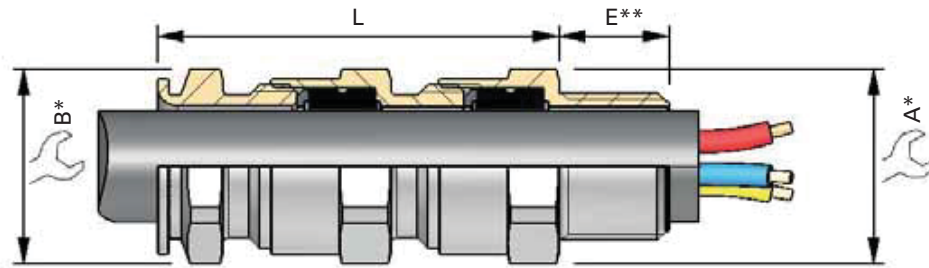

* For 'across corners' dimensions, multiply 'across flats' dimensions by 1.1

** For 'E' see Thread Dimension page 87

SERIES	THREAD SIZE	CABLE SEALING RANGE	MATERIAL	SEALING TYPE	OPTION
ADE2	M25	3	NP	N	

- 0 = XS
- 1 = S
- 2 = M
- 3 = L

VARIANT CODES	
K1	Accessories Kit 1
K2	Accessories Kit 2
K3	Accessories Kit 3
BLANK	No Option

N	Neoprene
S	Silicone

NP	Nickel-plated Brass
SS	Stainless Steel
BZ	Bronze
AL	Aluminum (not for mining applications)

KIT OPTIONS	
K1	Kit 1 Contents: • Locknut • Green Fiber Washer
K2	Kit 2 Contents: • Locknut • Green Fiber Washer • Earth Tag • Shroud
K3	Kit 3 Contents: • Locknut • Green Fiber Washer • Earth Tag • Serrated Washer

SELECTION TABLE						DIMENSIONS			GLAND SIZE	CATALOG NUMBER ISO	CATALOG NUMBER NPT	
SERIES	THREAD SIZE	THREAD SIZE CODE	THREAD SIZE	THREAD SIZE CODE	CABLE SEALING RANGE	CABLE SEALING RANGE ISO/(NPT)	A	B				L (LENGTH)
	ISO		NPT						OUTER SHEATH MIN - MAX			
ADE2	12	M12	-	-	3	4.5 - 8.0	17	17	42	4	ADE2M123NPN	-
ADE2	16	M16	-	-	2	4.5 - 8.5	17	19	42	4	ADE2M162NPN	-
ADE2	16	M16	-	-	3	7.0 - 12.0	19	19	47	5	ADE2M163NPN	-
ADE2	20	M20	1/2"	N050	0	2.7 - 5.5	15	24	42	3	ADE2M200NPN	ADE2N0500NPN
ADE2	20	M20	1/2"	N050	1	4.5 - 8.5	17	24	42	4	ADE2M201NPN	ADE2N0501NPN
ADE2	20	M20	1/2"	N050	2	7.0 - 12.0	19	24	47	5	ADE2M202NPN	ADE2N0502NPN
ADE2	20	M20	1/2"	N050	3	10.0 - 16.0 (15.5)	24	24	54	6	ADE2M203NPN	ADE2N0503NPN
ADE2	25	M25	3/4"	N075	1	7.0 - 12.0	19	30	47	5	ADE2M251NPN	ADE2N0751NPN
ADE2	25	M25	3/4"	N075	2	10.0 - 16.0	24	30	54	6	ADE2M252NPN	ADE2N0752NPN
ADE2	25	M25	3/4"	N075	3	13.5 - 20.5	30	30	63	7	ADE2M253NPN	ADE2N0753NPN
ADE2	32	M32	1"	N100	3	18.0 - 27.5 (26.0)	41	41	79	8	ADE2M323NPN	ADE2N1003NPN
ADE2	40	M40	1 1/4"	N125	3	23.0 - 34.0	48	48	86	9	ADE2M403NPN	ADE2N1253NPN
ADE2	50	M50	1 1/2"	N150	2	29.0 - 41.0	55	55	90	10	ADE2M502NPN	ADE2N1502NPN
ADE2	-	-	2"	N200	2	35.0 - 48.0	64	64	99	11	-	ADE2N2002NPN
ADE2	50	M50	-	-	3	35.0 - 45.0	64	64	99	11	ADE2M503NPN	-
ADE2	63	M63	2"	N200	3	42.0 - 56.0 (53.0)	72	72	106	12	ADE2M633NPN	ADE2N2003NPN
ADE2	75	M75	2 1/2"	N250	3	50.0 - 65.0 (62.5)	85	85	119	13	ADE2M753NPN	ADE2N2503NPN
ADE2	90	M90	3"	N300	2	58.0 - 74.0	95	95	123	14	ADE2M902NPN	ADE2N3002NPN
ADE2	90	M90	3"	N300	3	66.0 - 83.0 (78.0)	110	110	139	15	ADE2M903NPN	ADE2N3003NPN
ADE2	110	M110	3 1/2"	N350	2	75.0 - 93.0 (92.0)	120	120	139	16	ADE2M1102NPN	ADE2N3502NPN
ADE2	110	M110	4"	N400	3	85.0 - 104.0	135	135	156	17	ADE2M1103NPN	ADE2N4003NPN

* Not UL certified. All dimensions in mm. Above catalog numbers are for nickel-plated brass with neoprene seal; refer to order code diagram for other options.

If the material number (CAP) is required, please refer to pages 89-91.

For mining applications, please contact Customer Service.

Capri ADE 1F2 with Integral Clamping Module - for Non-armoured Cable

Technical Specification



Suitable for the following cable types

- Non-armoured cable
- Marine shipboard cable; Type P cable

Certifications and Compliances

Zones 1 and 2, Groups I, IIA, IIB and IIC
Zones 21 and 22, Groups IIIA, IIIB and IIIC

ATEX Certificate No.: INERIS12ATEX0032X

Ex db I, Ex eb I (for mining applications)

Ex db IIC, Ex eb IIC, Ex nRc IIC, Ex tb IIIC

IECEX Certificate No.: IECEX INE 12.0025X

Class I, Zone 1, AEx e II*

Class I, Zone 2, AEx e II, Ex e II

cULus Listed: E310130

Marine cULus Listed: E314047

*ADE sizes 3-8, 1/2" to 1 1/4" NPT or ISO 20 to 40
with TC-ER-HL unarmoured cable up to 1" diameter

DTS-01:91 Deluge Certification

Product Specification

Material:

Nickel-plated brass for superior corrosion resistance.
316 stainless steel, bronze and aluminum options available.
It is recommended that a suitable lubricant is used on all threads of stainless steel and aluminum versions.

Operating Temperature:

- Neoprene seal: -30°C to +80°C
- Silicone seal: -60°C to +140°C

Ingress Protection (IP)

Metric Threads:

Fitted on equipment with a flat surface, on threaded hole or on blank hole ("d" use excluded) fixed by a qualified locknut with all threads engaged:

- IP64 and IP66 without sealing washer and surface finish of Ra 0.4µm or on threaded hole and surface finish of Ra 1.6µm max.
- IP64 and IP66 with all sealing washers (red fiber, green fiber, neoprene, nylon or PTFE) on surface Ra 6.3µm max.
- IP68 tested 30m/7days with red fiber or green fiber sealing washers on surface Ra 6.3µm max.

NPT Threads:

- IP64, IP66 and IP68 tested 30m/7days, always fitted on equipment with threaded hole; HTL lubricant may be needed.

Clamping Technology

Elastomeric seal on cable outer sheath.

External cable clamping.



Features & Benefits

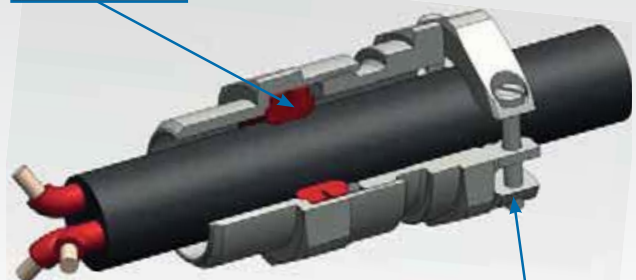
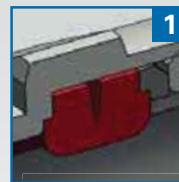

1: Specifically formulated elastomer for IP sealing on outer sheath of cable.

2: Integrated external cable clamping for strain relief.

Capri ADE 1F2 with Integral Clamping Module - Order Codes & Dimensions

Dimensions

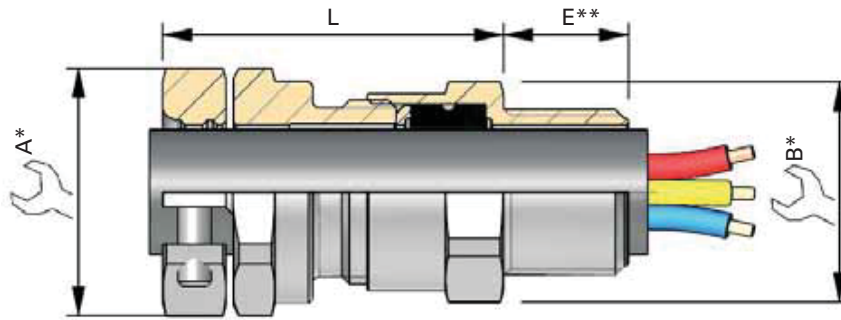

* For 'across corners' dimensions, multiply 'across flats' dimensions by 1.1

** For 'E' see Thread Dimension page 87

SERIES	HUB SIZE	CABLE SEALING RANGE	MATERIAL	SEALING TYPE	OPTION
ADE1A	M25	3	NP	N	

- 0 = XS
- 1 = S
- 2 = M
- 3 = L

SELECT

SELECT

SELECT

SELECT

VARIANT CODES	
K1	Accessories Kit 1
K2	Accessories Kit 2
K3	Accessories Kit 3
BLANK	No Option

N	Neoprene
S	Silicone

NP	Nickel-plated Brass
SS	Stainless Steel
BZ	Bronze
AL	Aluminum (not for mining applications)

KIT OPTIONS	
K1	Kit 1 Contents: • Locknut • Green Fiber Washer
K2	Kit 2 Contents: • Locknut • Green Fiber Washer • Earth Tag • Shroud
K3	Kit 3 Contents: • Locknut • Green Fiber Washer • Earth Tag • Serrated Washer

SELECTION TABLE					
SERIES	THREAD SIZE	THREAD SIZE CODE	THREAD SIZE	THREAD SIZE CODE	CABLE SEALING RANGE
	ISO		NPT		
ADE1A	16*	M16	-	-	2
ADE1A	16*	M16	-	-	3
ADE1A	20	M20	1/2"	N050	0
ADE1A	20	M20	1/2"	N050	1
ADE1A	20	M20	1/2"	N050	2
ADE1A	20	M20	1/2"	N050	3
ADE1A	25	M25	3/4"	N075	1
ADE1A	25	M25	3/4"	N075	2
ADE1A	25	M25	3/4"	N075	3
ADE1A	32	M32	1"	N100	3
ADE1A	40	M40	-	-	3

DIMENSIONS			
CABLE SEALING RANGE ISO/(NPT)	A	B	L (LENGTH)
4.5 - 8.5	20	19	32.0
7.0 - 12.0	24	19	35.0
2.8 - 5.5	15	24	28.0
4.5 - 8.5	20	24	32.0
7.0 - 12.0	24	24	35.0
10.0 - 16.0 (15.5)	27	24	40.0
7.0 - 12.0	24	30	40.0
10.0 - 16.0	27	30	40.0
13.5 - 20.5	32	30	45.0
18.0 - 27.5 (26.0)	41	41	55.0
23.0 - 34.0	48	48	59.0

GLAND SIZE	CATALOG NUMBER ISO	CATALOG NUMBER NPT
4	ADE1AM162NPN	-
5	ADE1AM163NPN	-
3	ADE1AM200NPN	ADE1AN0500NPN
4	ADE1AM201NPN	ADE1AN0501NPN
5	ADE1AM202NPN	ADE1AN0502NPN
6	ADE1AM203NPN	ADE1AN0503NPN
5	ADE1AM251NPN	ADE1AN0751NPN
6	ADE1AM252NPN	ADE1AN0752NPN
7	ADE1AM253NPN	ADE1AN0753NPN
8	ADE1AM323NPN	ADE1AN1003NPN
9	ADE1AM403NPN	-

* Not UL certified. All dimensions in mm. Above catalog numbers are for nickel-plated brass with neoprene seal; refer to order code diagram for other options.

If the material number (CAP) is required, please refer to pages 89-91.

For mining applications, please contact Customer Service.

Capri ADE 1FC - for Non-armoured Cable

Technical Specification



Suitable for the following cable types

- Non-armoured cable
- Marine shipboard cable; Type P cable

Certifications and Compliances

Zones 1 and 2, Groups I, IIA, IIB and IIC

Zones 21 and 22, Groups IIIA, IIIB and IIIC

ATEX Certificate No.: INERIS12ATEX0032X

Ex db I, Ex eb I, Ex db IIC, Ex eb IIC, Ex nRc IIC, Ex tb IIIC

IECEX Certificate No.: IECEX INE 12.0025X

Class I, Zone 2, AEx de II, Ex de II

cULus Listed: E310130

Class I, Division 2, Groups A, B, C, D

Marine UL Listed: E324850

DTS-01:91 Deluge Certification

Product Specification

Material:

Nickel-plated brass for superior corrosion resistance.
316 stainless steel and bronze options available.
It is recommended that a suitable lubricant is used on all threads of stainless steel versions.

Operating Temperature:

- TSC compound: -60°C to +80°C
(for UL marine certification, refer to pages 78-79)

Ingress Protection (IP)

Metric Threads:

Fitted on equipment with a flat surface, on threaded hole or on blank hole ("d" use excluded) fixed by a qualified locknut with all threads engaged:

- IP64 and IP66 without sealing washer and surface finish of Ra 0.4µm or on threaded hole and surface finish of Ra 1.6µm max.
- IP64 and IP66 with all sealing washers (red fiber, green fiber, neoprene, nylon or PTFE) on surface Ra 6.3µm max.
- IP68 tested 30m/7days with red fiber or green fiber sealing washers on surface Ra 6.3µm max.

NPT Threads:

- IP64, IP66 and IP68 tested 30m/7days, always fitted on equipment with threaded hole; HTL lubricant may be needed.

Clamping Technology

Elastomeric seal on cable outer sheath.
Compound barrier seal on cable conductors.
External cable clamping module (optional).



Features & Benefits

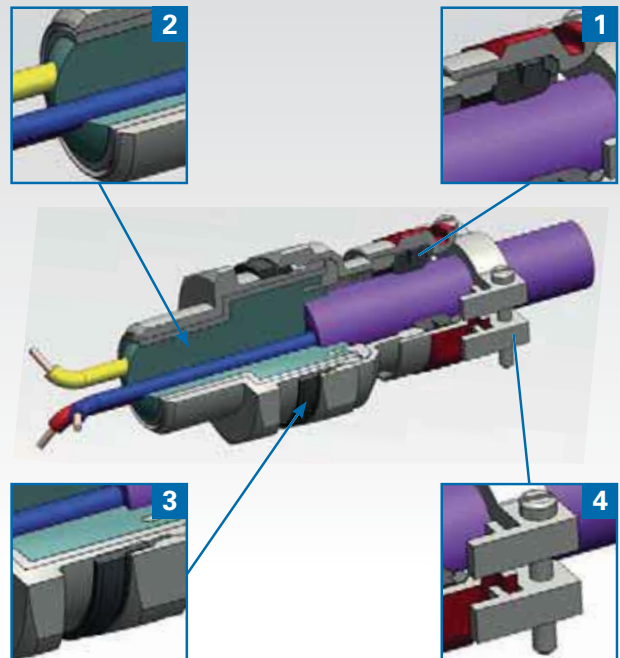

- 1: Specifically formulated elastomer for IP sealing on outer sheath of cable.
- 2: Sealing of cable conductors with compound barrier seal.
- 3: Deluge seal provides enhanced ingress protection.
- 4: Additional external cable clamping for strain relief (optional).

Capri ADE 1FC - Order Codes & Dimensions

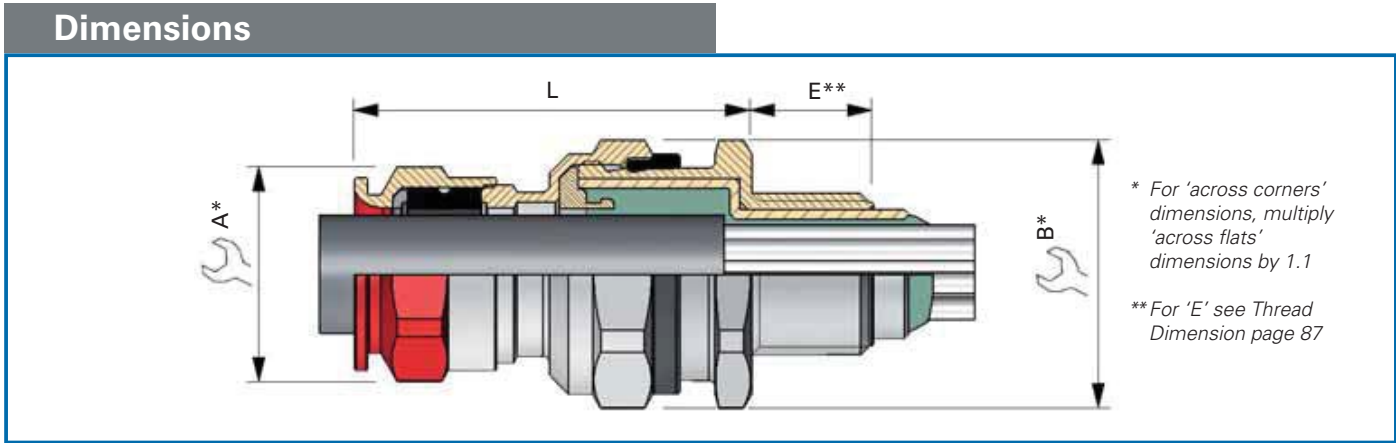

SERIES	THREAD SIZE	CABLE SEALING RANGE	MATERIAL	BARRIER	SEALING TYPE	OPTION
ADE1C	M25	3	NP	SC	N	

VARIANT CODES	
K1	Accessories Kit 1
K2	Accessories Kit 2
K3	Accessories Kit 3
BLANK	No Option

KIT OPTIONS	
K1	Kit 1 Contents: • Locknut • Green Fiber Washer
K2	Kit 2 Contents: • Locknut • Green Fiber Washer • Earth Tag • Shroud
K3	Kit 3 Contents: • Locknut • Green Fiber Washer • Earth Tag • Serrated Washer

SELECT	SELECT	SELECT	SELECT
0 = XS			
1 = S			
2 = M			
3 = L			

SELECT	SELECT	SELECT	SELECT
N	Neoprene		
S	Silicone		
SC	Solid Compound		
NP	Nickel-plated Brass		
SS	Stainless Steel		
BZ	Bronze		

SELECTION TABLE						DIMENSIONS						GLAND SIZE	CATALOG NUMBER ISO	CATALOG NUMBER NPT
SERIES	THREAD SIZE	THREAD SIZE CODE	THREAD SIZE	THREAD SIZE CODE	CABLE SEALING RANGE	SEALING RANGE MIN - MAX	CONDUCTORS		A	B	L (LENGTH)			
							C = Ø MAX OVER CORES	MAX NO. OF CORES						
ADE1C	16*	M16	3/8"*	N038	3	4.0 - 8.5	6.5	6	15	19	36.0	4	ADE1CM163NPSCN	ADE1CN0383NPSCN
ADE1C	20	M20	1/2"	N050	1	4.0 - 8.5	6.5	6	15	24	36.0	4	ADE1CM201NPSCN	ADE1CN0501NPSCN
ADE1C	20	M20	1/2"	N050	2	6.0 - 12.0	9.5	6	19	24	42.0	5	ADE1CM202NPSCN	ADE1CN0502NPSCN
ADE1C	20	M20	1/2"	N050	3	8.5 - 16.0	12.0	10	24	30	48.0	6	ADE1CM203NPSCN	ADE1CN0503NPSCN
ADE1C	25	M25	3/4"	N075	2	8.5 - 16.0	12.0	10	24	30	48.0	6	ADE1CM252NPSCN	ADE1CN0752NPSCN
ADE1C	25	M25	3/4"	N075	3	12.0 - 21.0	17.0	21	30	41	58.0	7	ADE1CM253NPSCN	ADE1CN0753NPSCN
ADE1C	32	M32	1"	N100	2	12.0 - 21.0	17.0	21	30	41	58.0	7	ADE1CM322NPSCN	ADE1CN1002NPSCN
ADE1C	32	M32	1"	N100	3	16.0 - 27.5	23.0	42	41	48	70.0	8	ADE1CM323NPSCN	ADE1CN1003NPSCN
ADE1C	40	M40	1 1/4"	N125	2	16.0 - 27.5	23.0	42	41	48	70.0	8	ADE1CM402NPSCN	ADE1CN1252NPSCN
ADE1C	40	M40	1 1/4"	N125	3	21.0 - 34.0	29.0	60	48	55	79.0	9	ADE1CM403NPSCN	ADE1CN1253NPSCN
ADE1C	50	M50	1 1/2"	N150	2	21.0 - 34.0	29.0	60	48	55	79.0	9	ADE1CM502NPSCN	ADE1CN1502NPSCN
ADE1C	50	M50	2"	N200	1	27.0 - 41.0	36.5	80	55	64	88.0	10	ADE1CM501NPSCN	ADE1CN2001NPSCN
ADE1C	63	M63	2"	N200	2	33.0 - 48.0	43.0	100	64	72	98.0	11	ADE1CM632NPSCN	ADE1CN2002NPSCN
ADE1C	63	M63	2"	N200	3	40.0 - 56.0	50.0	100	72	85	103.0	12	ADE1CM633NPSCN	ADE1CN2003NPSCN
ADE1C	-	-	2 1/2"	N250	2	40.0 - 56.0	50.0	100	72	85	103.0	12	-	ADE1CN2502NPSCN
ADE1C	75	M75	2 1/2"	N250	3	46.0 - 65.0	59.0	120	85	95	111.0	13	ADE1CM753NPSCN	ADE1CN2503NPSCN
ADE1C	-	-	3"	N300	1	46.0 - 65.0	59.0	120	85	95	111.0	13	-	ADE1CN3001NPSCN
ADE1C	90	M90	3"	N300	2	54.0 - 74.0	66.0	140	95	110	120.0	14	ADE1CM902NPSCN	ADE1CN3002NPSCN
ADE1C	-	-	3 1/2"	N350	2	54.0 - 74.0	66.0	140	95	110	120.0	14	-	ADE1CN3502NPSCN
ADE1C	90	M90	3"	N300	3	63.0 - 83.0	75.0	140	110	120	125.0	15	ADE1CM903NPSCN	ADE1CN3003NPSCN
ADE1C	-	-	3 1/2"	N350	3	63.0 - 83.0	75.0	140	110	120	125.0	15	-	ADE1CN3503NPSCN
ADE1C	110	M110	4"	N400	3	72.0 - 93.0	85.0	200	120	135	128.0	16	ADE1CM1103NPSCN	ADE1CN4003NPSCN

* Not UL certified. All dimensions in mm. Above catalog numbers are for nickel-plated brass with neoprene seal; refer to order code diagram for other options.

If the material number (CAP) is required, please refer to pages 89-91.

For mining applications, please contact Customer Service.

Capri ADE 4F - for Armoured Cable

Technical Specification



Suitable for the following cable types

- Steel wire armoured cable (SWA)
- Steel wire braided cable (SWB)
- Steel tape armoured cable (STA)
- Braided marine shipboard cable; Type P cable
- Lead sheathed cable (with addition of earthing washer)

Certifications and Compliances

Zones 1 and 2, Groups I, IIA, IIB and IIC
Zones 21 and 22, Groups IIIA, IIIB and IIIC

ATEX Certificate No.: INERIS12ATEX0032X
Ex db IIC, Ex db I, Ex eb I, Ex eb IIC, Ex nRc IIC, Ex tb IIIC

IECEX Certificate No.: IECEX INE 12.0025X

Class I, Zone 2, AEx e II, EX e II
cULus Listed: E310130

Class I, Zone 1, AEx e II, EX e II
Marine cULus Listed: E314047

DTS-01:91 Deluge Certification

Product Specification

Material:

Nickel-plated brass for superior corrosion resistance.
316 stainless steel, bronze and aluminum options available.
It is recommended that a suitable lubricant is used on all threads of stainless steel and aluminum versions.

Operating Temperature:

- Neoprene seal: -30°C to +80°C
- Silicone seal: -60°C to +140°C

Ingress Protection (IP)

Metric Threads:

Fitted on equipment with a flat surface, on threaded hole or on blank hole ("d" use excluded) fixed by a qualified locknut with all threads engaged:

- IP64 and IP66 without sealing washer and surface finish of Ra 0.4µm or on threaded hole and surface finish of Ra 1.6µm max.
- IP64 and IP66 with all sealing washers (red fiber, green fiber, neoprene, nylon or PTFE) on surface Ra 6.3µm max.
- IP68 tested 30m/7days with red fiber or green fiber sealing washers on surface Ra 6.3µm max.

NPT Threads:

- IP64, IP66 and IP68 tested 30m/7days, always fitted on equipment with threaded hole; HTL lubricant may be needed.

Clamping Technology

Elastomeric seal on cable outer sheath.
Universal armour clamping and bonding for electrical continuity.
Elastomeric seal on cable inner sheath.
External cable clamping module (optional).



Features & Benefits

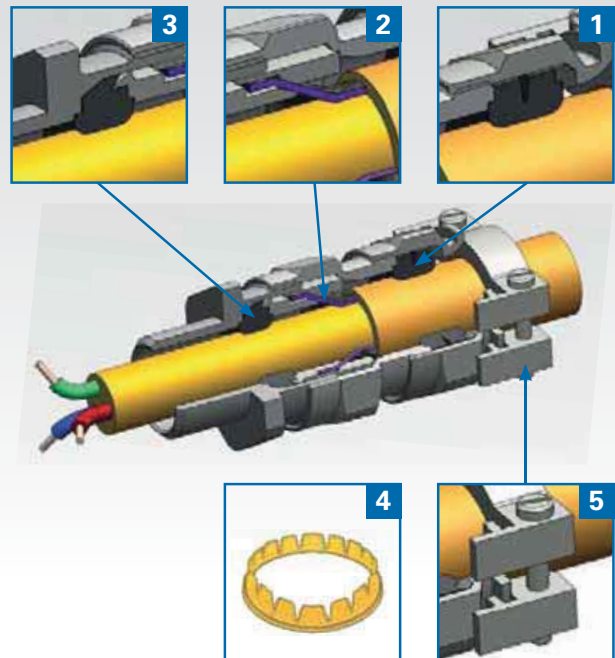

- 1: Specifically formulated elastomer for IP sealing on outer sheath of cable.
- 2: Universal clamping design for earthing and bonding of armour shield. Provides mechanical strength and is suitable for all armour shield types, with no requirement to reverse components that may introduce risk of incorrect installation.
- 3: Specifically formulated elastomer for flame path sealing on inner sheath of the cable.
- 4: Suitable for lead sheath cable with installation of simple washer.
- 5: Additional external cable clamping for strain relief (optional).

Capri ADE 4F - Order Codes & Dimensions

Dimensions

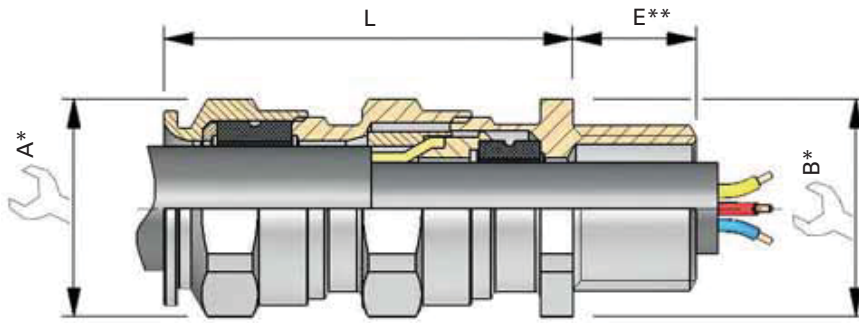

* For 'across corners' dimensions, multiply 'across flats' dimensions by 1.1

** For 'E' see Thread Dimension page 87

SERIES	THREAD SIZE	CABLE SEALING RANGE	MATERIAL	SEALING TYPE	OPTION
ADE4	M25	3	NP	N	

- 0 = XS
- 1 = S
- 2 = M
- 3 = L

VARIANT CODES	
K1	Accessories Kit 1
K2	Accessories Kit 2
K3	Accessories Kit 3
BLANK	No Option

N	Neoprene
S	Silicone

NP	Nickel-plated Brass
SS	Stainless Steel
BZ	Bronze
AL	Aluminum (not for mining applications)

KIT OPTIONS	
K1	Kit 1 Contents: • Locknut • Green Fiber Washer
K2	Kit 2 Contents: • Locknut • Green Fiber Washer • Earth Tag • Shroud
K3	Kit 3 Contents: • Locknut • Green Fiber Washer • Earth Tag • Serrated Washer

SELECTION TABLE						DIMENSIONS					GLAND SIZE	CATALOG NUMBER ISO	CATALOG NUMBER NPT	
SERIES	THREAD SIZE	THREAD SIZE CODE	THREAD SIZE	THREAD SIZE CODE	CABLE SEALING RANGE	CABLE SEALING RANGE		ARMOUR RANGE MIN - MAX	A	B				L (LENGTH)
	ISO	NPT	INNER SHEATH MIN - MAX	OUTER SHEATH MIN - MAX										
ADE4	12*	M12	1/4"	N025	3	4.5 - 8.0	7.0 - 12.0	0.2 - 0.9	19	19	46.0	5	ADE4M123NPN	ADE4N0253NPN
ADE4	16*	M16	3/8"	N038	1	2.8 - 5.5	4.5 - 8.5	0.2 - 0.9	17	19	41.0	4	ADE4M161NPN	ADE4N0381NPN
ADE4	16*	M16	3/8"	N038	2	4.5 - 8.0	7.0 - 12.0	0.2 - 0.9	19	19	46.0	5	ADE4M162NPN	ADE4N0382NPN
ADE4	16*	M16	3/8"	N038	3	7.0 - 12.0	10.0 - 16.0	0.2 - 1.3	24	24	51.0	6	ADE4M163NPN	ADE4N0383NPN
ADE4	20	M20	1/2"	N050	0	2.8 - 5.5	4.5 - 8.5	0.2 - 0.9	17	24	41.0	4	ADE4M200NPN	ADE4N0500NPN
ADE4	20	M20	1/2"	N050	1	4.5 - 8.0	7.0 - 12.0	0.2 - 0.9	19	24	46.0	5	ADE4M201NPN	ADE4N0501NPN
ADE4	20	M20	1/2"	N050	2	7.0 - 12.0	10.0 - 16.0	0.2 - 1.3	24	24	51.0	6	ADE4M202NPN	ADE4N0502NPN
ADE4	20	M20	1/2"	N050	3	10.0 - 15.5	13.5 - 21.0	0.2 - 1.3	30	30	57.5	7	ADE4M203NPN	ADE4N0503NPN
ADE4	25	M25	3/4"	N075	1	7.0 - 12.0	10.0 - 16.0	0.2 - 1.3	24	30	51.0	6	ADE4M251NPN	ADE4N0751NPN
ADE4	25	M25	3/4"	N075	2	10.0 - 15.5	13.5 - 21.0	0.2 - 1.3	30	30	57.5	7	ADE4M252NPN	ADE4N0752NPN
ADE4	25	M25	3/4"	N075	3	13.5 - 20.5	18.0 - 27.5	0.2 - 1.6	41	41	68.0	8	ADE4M253NPN	ADE4N0753NPN
ADE4	32	M32	1"	N100	2	13.5 - 21.0	18.0 - 27.5	0.2 - 1.6	41	41	68.0	8	ADE4M322NPN	ADE4N1002NPN
ADE4	32	M32	1"	N100	3	18.0 - 26.0	23.0 - 34.0	0.2 - 1.6	48	48	76.0	9	ADE4M323NPN	ADE4N1003NPN
ADE4	40	M40	1 1/4"	N125	2	18.0 - 27.5	23.0 - 34.0	0.2 - 1.6	48	48	76.0	9	ADE4M402NPN	ADE4N1252NPN
ADE4	40	M40	1 1/4"	N125	3	23.0 - 34.0	29.0 - 41.0	0.2 - 2.0	55	55	88.0	10	ADE4M403NPN	ADE4N1253NPN
ADE4	50	M50	1 1/2"	N150	2	23.0 - 34.0	29.0 - 41.0	0.2 - 2.0	55	55	88.0	10	ADE4M502NPN	ADE4N1502NPN
ADE4	50	M50	1 1/2"	N150	3	29.0 - 41.0	35.0 - 48.0	0.2 - 2.5	64	64	97.0	11	ADE4M503NPN	ADE4N1503NPN
ADE4	63	M63	2"	N200	2	35.0 - 48.0	42.0 - 56.0	0.2 - 2.5	72	72	102.0	12	ADE4M632NPN	ADE4N2002NPN
ADE4	63	M63	2"	N200	3	42.0 - 53.0	50.0 - 65.0	0.2 - 2.5	85	85	117.0	13	ADE4M633NPN	ADE4N2003NPN
ADE4	75	M75	2 1/2"	N250	2	42.0 - 56.0	50.0 - 65.0	0.2 - 2.5	85	85	117.0	13	ADE4M752NPN	ADE4N2502NPN
ADE4	75	M75	2 1/2"	N250	3	50.0 - 62.5	58.0 - 74.0	0.2 - 2.5	95	95	124.0	14	ADE4M753NPN	ADE4N2503NPN
ADE4	90	M90	3"	N300	1	58.0 - 74.0	66.0 - 83.0	0.2 - 3.2	110	110	133.0	15	ADE4M901NPN	ADE4N3001NPN
ADE4	90	M90	3"	N300	2	66.0 - 78.0	75.0 - 93.0	0.2 - 3.2	120	120	140.0	16	ADE4M902NPN	ADE4N3002NPN
ADE4	90	M90	3 1/2"	N350	3	66.0 - 83.0	85.0 - 104.0	0.2 - 3.5	135	135	150.0	17	ADE4M903NPN	ADE4N3503NPN
ADE4	110	M110	4"	N400	3	75.0 - 93.0	85.0 - 104.0	0.2 - 3.5	135	135	150.0	17	ADE4M1103NPN	ADE4N4003NPN

* Not UL certified. All dimensions in mm. Above catalog numbers are for nickel-plated brass with neoprene seal; refer to order code diagram for other options.

If the material number (CAP) is required, please refer to pages 89-91.

For mining applications, please contact Customer Service.

Capri ADE 5F - for Armoured Cable

Technical Specification



Suitable for the following cable types

- Steel wire armoured cable (SWA)
- Steel wire braided cable (SWB)
- Steel tape armoured cable (STA)
- Braided marine shipboard cable; Type P cable
- Lead sheathed cable (with addition of earthing washer)

Certifications and Compliances

Zones 1 and 2, Groups IIA, IIB and IIC

Zones 21 and 22, Groups IIIA, IIIB and IIIC

ATEX Certificate No.: INERIS12ATEX0032X

II2GD / Ex db IIC / Ex eb IIC / Ex tb IIIC

II3G Ex nRc IIC, IM2 Ex db I Ex eb I

IECEX Certificate No.: IECEX INE 12.0025X

Class I, Zone 2, AEx e II, EX e II

cULus Listed: E310130

Class I, Zone 1, AEx e II, EX e II

Marine cULus Listed: E314047

Product Specification

Material:

Nickel-plated brass for superior corrosion resistance.
316 stainless steel, bronze and aluminum options available.
It is recommended that a suitable lubricant is used on all threads of stainless steel and aluminum versions.

Operating Temperature:

- Neoprene seal: -30°C to +80°C
- Silicone seal: -60°C to +140°C

Ingress Protection (IP)

Metric Threads:

Fitted on equipment with a flat surface, on threaded hole or on blank hole ("d" use excluded) fixed by a qualified locknut with all threads engaged:

- IP64 and IP66 without sealing washer and surface finish of Ra 0.4µm or on threaded hole and surface finish of Ra 1.6µm max.
- IP64 and IP66 with all sealing washers (red fiber, green fiber, neoprene, nylon or PTFE) on surface Ra 6.3µm max.
- IP68 tested 30m/7days with red fiber or green fiber sealing washers on surface Ra 6.3µm max.

NPT Threads:

- IP64, IP66 and IP68 tested 30m/7days, always fitted on equipment with threaded hole; HTL lubricant may be needed.

Clamping Technology

Elastomeric seal on cable outer sheath.
Universal armour clamping and bonding for electrical continuity.
Elastomeric seal on cable inner sheath.
External cable clamping module (optional).



Features & Benefits

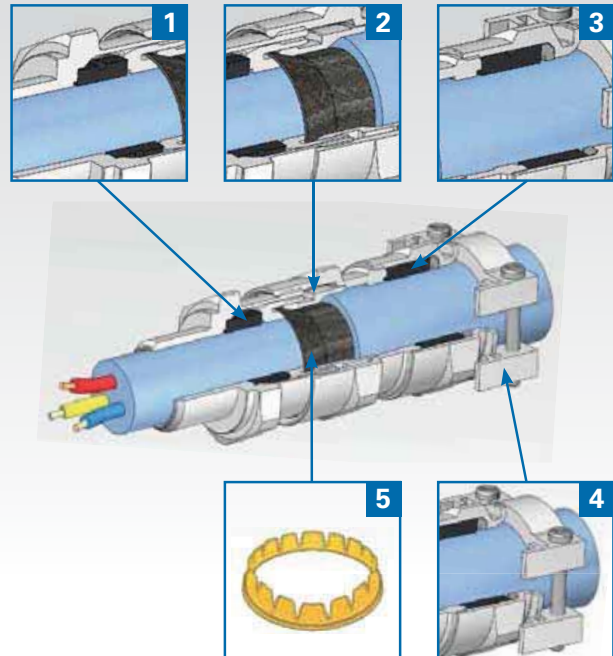

- 1: Specifically formulated elastomer for flame path sealing on inner sheath of cable.
- 2: Universal and inspectable armour clamping and grounding system.
- 3: Specifically formulated elastomer for IP sealing on outer sheath of cable.
- 4: Additional external cable clamping for strain relief (optional).
- 5: Suitable for lead sheath cable with installation of simple washer (optional).

Capri ADE 5F - Order Codes & Dimensions

Dimensions

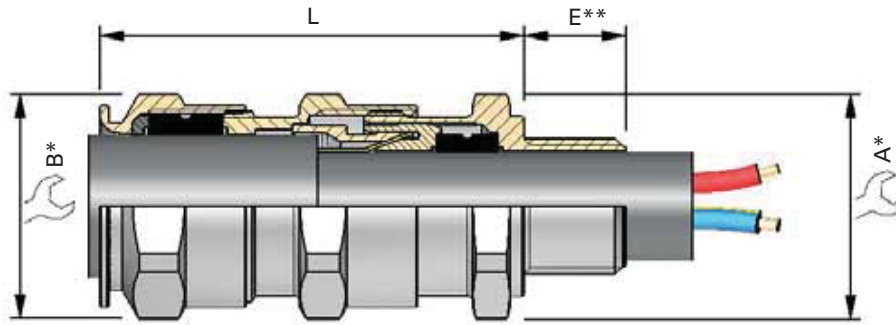

* For 'across corners' dimensions, multiply 'across flats' dimensions by 1.1

** For 'E' see Thread Dimension page 87

SERIES	THREAD SIZE	CABLE SEALING RANGE	MATERIAL	SEALING TYPE	OPTION
ADE5	M25	3	NP	N	

- 0 = XS
- 1 = S
- 2 = M
- 3 = L

SELECT

SELECT

SELECT

SELECT

VARIANT CODES	
K1	Accessories Kit 1
K2	Accessories Kit 2
K3	Accessories Kit 3
BLANK	No Option

N	Neoprene
S	Silicone

NP	Nickel-plated Brass
SS	Stainless Steel
BZ	Bronze
AL	Aluminum (not for mining applications)

KIT OPTIONS	
K1	Kit 1 Contents: • Locknut • Green Fiber Washer
K2	Kit 2 Contents: • Locknut • Green Fiber Washer • Earth Tag • Shroud
K3	Kit 3 Contents: • Locknut • Green Fiber Washer • Earth Tag • Serrated Washer

SELECTION TABLE						DIMENSIONS					GLAND SIZE	CATALOG NUMBER ISO	CATALOG NUMBER NPT	
SERIES	THREAD SIZE	THREAD SIZE CODE	THREAD SIZE	THREAD SIZE CODE	CABLE SEALING RANGE	CABLE SEALING RANGE		ARMOUR RANGE MIN - MAX	A	B				L (LENGTH)
	ISO		NPT			INNER SHEATH MIN - MAX	OUTER SHEATH MIN - MAX							
ADE5	12*	M12	1/4''*	N025	3	4.5 - 8.0	7.0 - 12.0	0.2 - 0.9	19	19	55.0	5	ADE5M123NPN	ADE5N0253NPN
ADE5	16*	M16	3/8''*	N038	2	4.5 - 8.0	7.0 - 12.0	0.2 - 0.9	19	19	55.0	5	ADE5M162NPN	ADE5N0382NPN
ADE5	16*	M16	3/8''*	N038	3	7.0 - 12.0	10.0 - 16.0	0.2 - 1.2	24	24	57.0	6	ADE5M163NPN	ADE5N0383NPN
ADE5	20	M20	1/2''	N050	1	4.5 - 8.0	7.0 - 12.0	0.2 - 0.9	19	24	55.0	5	ADE5M201NPN	ADE5N0501NPN
ADE5	20	M20	1/2''	N050	2	7.0 - 12.0	10.0 - 16.0	0.2 - 1.2	24	24	57.0	6	ADE5M202NPN	ADE5N0502NPN
ADE5	20	M20	1/2''	N050	3	10.0 - 15.5	13.5 - 21.0	0.2 - 1.2	30	30	64.0	7	ADE5M203NPN	ADE5N0503NPN
ADE5	25	M25	3/4''	N075	1	7.0 - 12.0	10.0 - 16.0	0.2 - 1.2	24	30	57.0	6	ADE5M251NPN	ADE5N0751NPN
ADE5	25	M25	3/4''	N075	2	10.0 - 15.5	13.5 - 21.0	0.2 - 1.2	30	30	64.0	7	ADE5M252NPN	ADE5N0752NPN
ADE5	25	M25	3/4''	N075	3	13.5 - 20.5	18.0 - 27.5	0.2 - 1.6	41	41	75.0	8	ADE5M253NPN	ADE5N0753NPN
ADE5	32	M32	1''	N100	2	13.5 - 21.0	18.0 - 27.5	0.2 - 1.6	41	41	75.0	8	ADE5M322NPN	ADE5N1002NPN
ADE5	32	M32	1''	N100	3	18.0 - 26.0	23.0 - 34.0	0.2 - 1.6	48	48	83.0	9	ADE5M323NPN	ADE5N1003NPN
ADE5	40	M40	1 1/4''	N125	2	18.0 - 27.5	23.0 - 34.0	0.2 - 1.6	48	48	83.0	9	ADE5M402NPN	ADE5N1252NPN
ADE5	40	M40	1 1/4''	N125	3	23.0 - 34.0	29.0 - 41.0	0.2 - 2.0	55	55	90.0	10	ADE5M403NPN	ADE5N1253NPN
ADE5	50	M50	1 1/2''	N150	2	23.0 - 34.0	29.0 - 41.0	0.2 - 2.0	55	55	90.0	10	ADE5M502NPN	ADE5N1502NPN
ADE5	50	M50	1 1/2''	N150	3	29.0 - 41.0	35.0 - 48.0	0.2 - 2.5	64	64	99.0	11	ADE5M503NPN	ADE5N1503NPN
ADE5	63	M63	2''	N200	2	35.0 - 48.0	42.0 - 56.0	0.2 - 2.5	72	72	108.0	12	ADE5M632NPN	ADE5N2002NPN
ADE5	63	M63	2''	N200	3	42.0 - 53.0	50.0 - 65.0	0.2 - 2.5	85	85	120.0	13	ADE5M633NPN	ADE5N2003NPN
ADE5	75	M75	2 1/2''	N250	2	42.0 - 56.0	50.0 - 65.0	0.2 - 2.5	85	85	120.0	13	ADE5M752NPN	ADE5N2502NPN
ADE5	75	M75	2 1/2''	N250	3	50.0 - 62.5	58.0 - 74.0	0.2 - 2.5	95	95	128.0	14	ADE5M753NPN	ADE5N2503NPN
ADE5	90	M90	3''	N300	2	58.0 - 74.0	66.0 - 83.0	0.2 - 3.1	110	110	150.0	15	ADE5M902NPN	ADE5N3002NPN
ADE5	90	M90	3''	N300	3	66.0 - 78.0	75.0 - 93.0	0.2 - 3.1	120	120	160.0	16	ADE5M903NPN	ADE5N3003NPN
ADE5	90	M90	3 1/2''	N350	3	66.0 - 83.0	85.0 - 104.0	0.2 - 3.5	135	135	172.0	17/16	ADE5M903NPN	ADE5N3503NPN
ADE5	110	M110	4''	N400	3	75.0 - 93.0	85.0 - 104.0	0.2 - 3.5	135	135	172.0	17	ADE5M1103NPN	ADE5N4003NPN

* Not UL certified. All dimensions in mm. Above catalog numbers are for nickel-plated brass with neoprene seal; refer to order code diagram for other options.

If the material number (CAP) is required, please refer to pages 89-91.

For mining applications, please contact Customer Service.

Capri ADE 6F - for Armoured Cable

Technical Specification



Suitable for the following cable types

- Steel wire armoured cable (SWA)
- Steel wire braided cable (SWB)
- Steel tape armoured cable (STA)
- Braided marine shipboard cable; Type P cable

Certifications and Compliances

Zones 1 and 2, Groups IIA, IIB and IIC

Zones 21 and 22, Groups IIIA, IIIB and IIIC

ATEX Certificate No.: INERIS12ATEX0032X

EX db IIC, Ex eb IIC, Ex nRc IIC, Ex tb IIIC

IECEX Certificate No.: IECEX INE 12.0025X

Class I, Zone 2, AEx e II, Ex e II

cULus Listed: E310130

Class I, Zone 1, AEx e II, Ex e II

Marine cULus Listed: E314047

DTS-01 Deluge Certification

Product Specification

Material:

Nickel-plated brass for superior corrosion resistance.
316 stainless steel, bronze and aluminum options available.
It is recommended that a suitable lubricant is used on all threads of stainless steel and aluminum versions.

Operating Temperature:

- Silicone seal: -60°C to +80°C

Ingress Protection (IP)

Metric Threads:

Fitted on equipment with a flat surface, on threaded hole or on blank hole ("d" use excluded) fixed by a qualified locknut with all threads engaged:

- IP64 and IP66 without sealing washer and surface finish of Ra 0.4µm or on threaded hole and surface finish of Ra 1.6µm max.
- IP64 and IP66 with all sealing washers (red fiber, green fiber, neoprene, nylon or PTFE) on surface Ra 6.3µm max.
- IP68 tested 30m/7days with red fiber or green fiber sealing washers on surface Ra 6.3µm max.

NPT Threads:

- IP64, IP66 and IP68 tested 30m/7days, always fitted on equipment with threaded hole; HTL lubricant may be needed.

Clamping Technology

Elastomeric seal on cable outer sheath.

Universal armour clamping and bonding for electrical continuity.

Cold flow protection diaphragm seal on cable inner sheath.

External cable clamping module (optional).



Features & Benefits

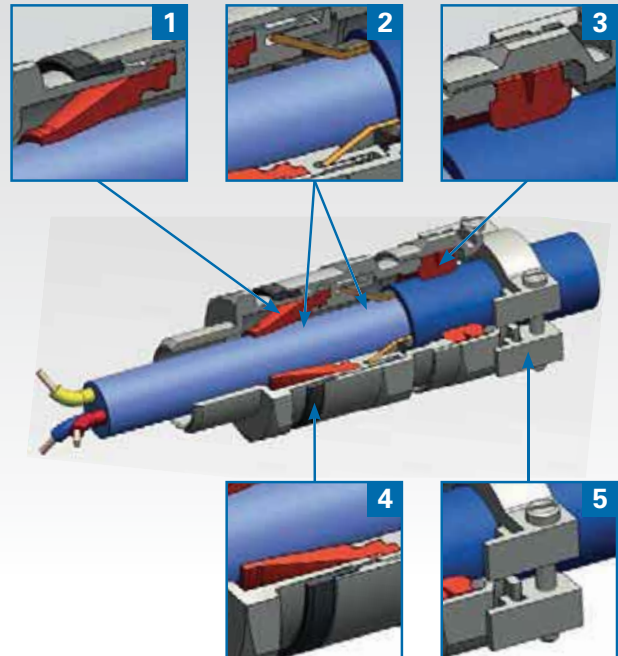

- 1: Specifically formulated diaphragm seal offers cold flow protection when required and sealing on cable inner sheath.
- 2: Universal clamping design for earthing and bonding of armour shield. Provides mechanical strength and is suitable for all armour shield types, with no requirement to reverse components that may introduce risk of incorrect installation. Fully inspectable.
- 3: Specifically formulated elastomer for IP sealing on outer sheath of cable.
- 4: Deluge performance to avoid water ingress through the thread.
- 5: Additional external cable clamping for strain relief (optional).

Capri ADE 6F - Order Codes & Dimensions

Dimensions

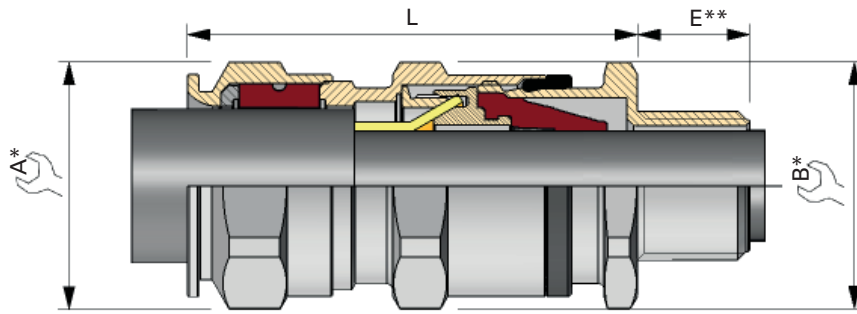

* For 'across corners' dimensions, multiply 'across flats' dimensions by 1.1

** For 'E' see Thread Dimension page 87

SERIES	THREAD SIZE	CABLE SEALING RANGE	MATERIAL	SEALING TYPE	OPTION
ADE6	M25	3	NP	S	

- 0 = XS
- 1 = S
- 2 = M
- 3 = L

SELECT

SELECT

SELECT

SELECT

VARIANT CODES	
K1	Accessories Kit 1
K2	Accessories Kit 2
K3	Accessories Kit 3
BLANK	No Option

S	Silicone
NP	Nickel-plated Brass
SS	Stainless Steel
BZ	Bronze
AL	Aluminum

KIT OPTIONS	
K1	Kit 1 Contents: • Locknut • Green Fiber Washer
K2	Kit 2 Contents: • Locknut • Green Fiber Washer • Earth Tag • Shroud
K3	Kit 3 Contents: • Locknut • Green Fiber Washer • Earth Tag • Serrated Washer

SELECTION TABLE						DIMENSIONS						GLAND SIZE	CATALOG NUMBER ISO	CATALOG NUMBER NPT
SERIES	THREAD SIZE	THREAD SIZE CODE	THREAD SIZE	THREAD SIZE CODE	CABLE SEALING RANGE	CABLE SEALING RANGE		ARMOUR RANGE MIN - MAX	A	B	L (LENGTH)			
	ISO	NPT	INNER SHEATH MIN - MAX	OUTER SHEATH MIN - MAX										
ADE6	16*	M16	3/8"	N038	3	3.0 - 7.5	6.0 - 12.0	0.2 - 0.9	19	19	47.5	5	ADE6M163NPS	ADE6N0383NPS
ADE6	20	M20	1/2"	N050	1	3.0 - 7.5	6.0 - 12.0	0.2 - 0.9	19	19	47.5	5	ADE6M201NPS	ADE6N0501NPS
ADE6	20	M20	1/2"	N050	2	6.5 - 11.0	8.5 - 16.0	0.2 - 1.3	24	24	54.5	6	ADE6M202NPS	ADE6N0502NPS
ADE6	20	M20	1/2"	N050	3	9.0 - 14.5	12.0 - 21.0	0.2 - 1.3	30	30	60.5	7	ADE6M203NPS	ADE6N0503NPS
ADE6	25	M25	3/4"	N075	2	9.0 - 14.5	12.0 - 21.0	0.2 - 1.3	30	30	60.5	7	ADE6M252NPS	ADE6N0752NPS
ADE6	25	M25	3/4"	N075	3	12.0 - 19.5	16.0 - 27.5	0.2 - 1.6	41	41	74.0	8	ADE6M253NPS	ADE6N0753NPS
ADE6	32	M32	1"	N100	2	12.0 - 19.5	16.0 - 27.5	0.2 - 1.6	41	41	74.0	8	ADE6M322NPS	ADE6N1002NPS
ADE6	32	M32	1"	N100	3	17.5 - 26.0	21.0 - 34.0	0.2 - 1.6	48	48	83.0	9	ADE6M323NPS	ADE6N1003NPS
ADE6	40	M40	1 1/4"	N125	2	17.5 - 26.0	21.0 - 34.0	0.2 - 1.6	48	48	83.0	9	ADE6M402NPS	ADE6N1252NPS
ADE6	40	M40	1 1/4"	N125	3	23.0 - 33.0	27.0 - 41.0	0.2 - 2.0	55	55	92.0	10	ADE6M403NPS	ADE6N1253NPS
ADE6	50	M50	1 1/2"	N150	2	23.0 - 33.0	27.0 - 41.0	0.2 - 2.0	55	55	92.0	10	ADE6M502NPS	ADE6N1502NPS
ADE6	50	M50	2"	N200	3	28.5 - 41.0	33.0 - 48.0	0.2 - 2.5	64	64	104.0	11	ADE6M503NPS	ADE6N2003NPS

* Not UL certified. All dimensions in mm. Above catalog numbers are for nickel-plated brass with neoprene seal; refer to order code diagram for other options.

If the material number (CAP) is required, please refer to pages 89-91.

Capri ADE 6FC - for Armoured Cable

Technical Specification



Suitable for the following cable types

- Steel wire armoured cable (SWA)
- Steel wire braided cable (SWB)
- Steel tape armoured cable (STA)
- Braided marine shipboard cable; Type P cable

Certifications and Compliances

Zones 1 and 2, Groups I, IIA, IIB and IIC

Zones 21 and 22, Groups IIIA, IIIB and IIIC

ATEX Certificate No.: INERIS12ATEX0032X

Ex db I, Ex eb I, Ex db IIC, Ex eb IIC, Ex nRc IIC, Ex tb IIIC

IECEX Certificate No.: IECEX INE 12.0025X

Class I, Zone 2, AEx de II, Ex de II

cULus Listed: E310130

Class I, Division 1, Groups A, B, C, D

Marine UL Listed: E324850

DTS-01 Deluge Certification

Product Specification

Material:

Nickel-plated brass for superior corrosion resistance.

316 stainless steel and bronze options available.

It is recommended that a suitable lubricant is used on all threads of stainless steel versions.

Operating Temperature:

- TSC compound: -60°C to +80°C
(for UL marine certification, refer to pages 78-79)

Ingress Protection (IP)

Metric Threads:

Fitted on equipment with a flat surface, on threaded hole or on blank hole ("d" use excluded) fixed by a qualified locknut with all threads engaged:

- IP64 and IP66 without sealing washer and surface finish of Ra 0.4µm or on threaded hole and surface finish of Ra 1.6µm max.
- IP64 and IP66 with all sealing washers (red fiber, green fiber, neoprene, nylon or PTFE) on surface Ra 6.3µm max.
- IP68 tested 30m/7days with red fiber or green fiber sealing washers on surface Ra 6.3µm max.

NPT Threads:

- IP64, IP66 and IP68 tested 30m/7days, always fitted on equipment with threaded hole; HTL lubricant may be needed.

Clamping Technology

Elastomeric seal on cable outer sheath.

Compound barrier seal on cable conductors.

Universal armour clamping and bonding for electrical continuity.

External cable clamping module (optional).



Features & Benefits

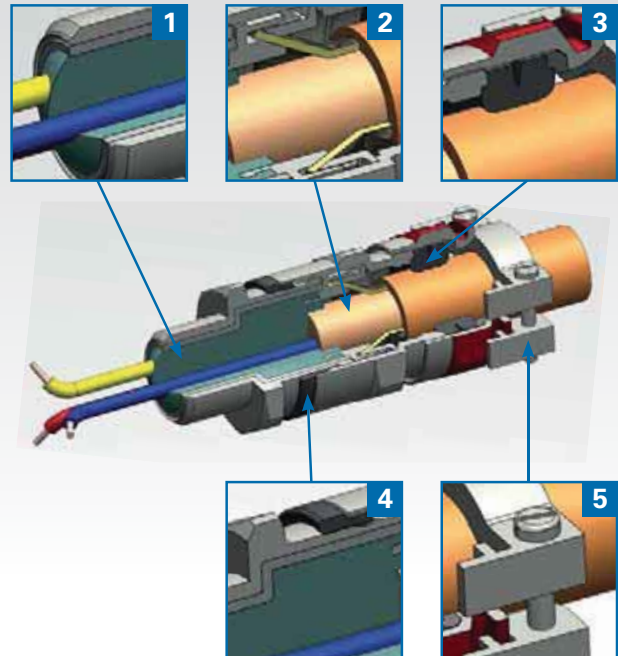

- 1: Sealing of cable conductors with compound barrier seal.
- 2: Universal clamping design for earthing and bonding of armour shield. Provides mechanical strength and is suitable for all armour shield types, with no requirement to reverse components that may introduce risk of incorrect installation. Fully inspectable.
- 3: Specifically formulated elastomer for IP sealing on outer sheath of cable.
- 4: Deluge performance to avoid water ingress through the thread.
- 5: Additional external cable clamping for strain relief (optional).

Capri ADE 6FC - Order Codes & Dimensions

Dimensions

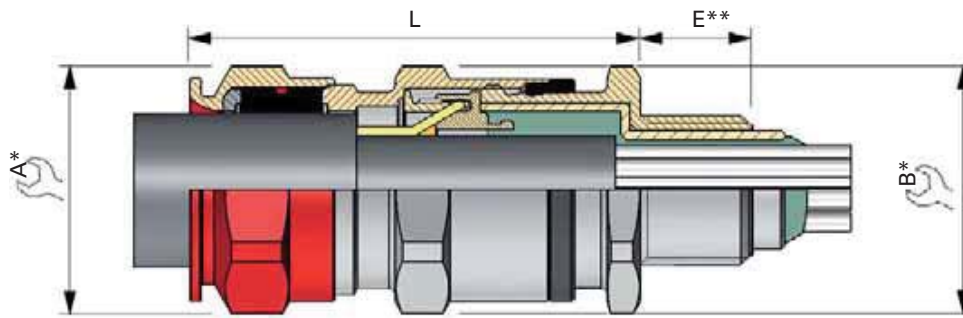

* For 'across corners' dimensions, multiply 'across flats' dimensions by 1.1

** For 'E' see Thread Dimension page 87

SERIES	THREAD SIZE	CABLE SEALING RANGE	MATERIAL	BARRIER	SEALING TYPE	OPTION
ADE6C	M25	3	NP	SC	N	

- 0 = XS
- 1 = S
- 2 = M
- 3 = L

VARIANT CODES	
K1	Accessories Kit 1
K2	Accessories Kit 2
K3	Accessories Kit 3
BLANK	No Option

N	Neoprene
S	Silicone

SC	Solid Compound
----	----------------

NP	Nickel-plated Brass
SS	Stainless Steel
BZ	Bronze

KIT OPTIONS	
K1	Kit 1 Contents: • Locknut • Green Fiber Washer
K2	Kit 2 Contents: • Locknut • Green Fiber Washer • Earth Tag • Shroud
K3	Kit 3 Contents: • Locknut • Green Fiber Washer • Earth Tag • Serrated Washer

SELECTION TABLE						DIMENSIONS								GLAND SIZE	CATALOG NUMBER ISO	CATALOG NUMBER NPT
SERIES	THREAD SIZE	THREAD SIZE CODE	THREAD SIZE	THREAD SIZE CODE	CABLE SEALING RANGE	OUTER SHEATH MIN - MAX	CONDUCTORS			MAX ARMOUR THICKNESS	A	B	L (LENGTH)			
							C=Ø MAX COVER CORES	Ø MAX INNER SHEATH	MAX NO. OF CORES							
	ISO		NPT													
ADE6C	16*	M16	3/8**	N038	3	6.0 - 12.0	6.5	8.0	6	0.9	19	19	47.5	5	ADE6CM163NPSCN	ADE6CN038NPSCN
ADE6C	20	M20	1/2"	N050	1	6.0 - 12.0	6.5	8.0	6	0.9	19	24	47.5	5	ADE6CM201NPSCN	ADE6CN0501NPSCN
ADE6C	20	M20	1/2"	N050	2	8.5 - 16.0	9.5	12.0	6	1.2	24	24	54.5	6	ADE6CM202NPSCN	ADE6CN0502NPSCN
ADE6C	20	M20	1/2"	N050	3	12.0 - 21.0	12.0	16.0	10	1.2	30	30	60.5	7	ADE6CM203NPSCN	ADE6CN0503NPSCN
ADE6C	25	M25	3/4"	N075	2	12.0 - 21.0	12.0	16.0	10	1.2	30	30	60.5	7	ADE6CM252NPSCN	ADE6CN0752NPSCN
ADE6C	25	M25	3/4"	N075	3	16.0 - 27.5	17.0	21.0	21	1.6	41	41	74.0	8	ADE6CM253NPSCN	ADE6CN0753NPSCN
ADE6C	32	M32	1"	N100	2	16.0 - 27.5	17.0	21.0	21	1.6	41	41	74.0	8	ADE6CM322NPSCN	ADE6CN1002NPSCN
ADE6C	32	M32	1"	N100	3	21.0 - 34.0	23.0	27.5	42	1.6	48	48	83.0	9	ADE6CM323NPSCN	ADE6CN1003NPSCN
ADE6C	40	M40	1 1/4"	N125	2	21.0 - 34.0	23.0	27.5	42	1.6	48	48	83.0	9	ADE6CM402NPSCN	ADE6CN1252NPSCN
ADE6C	40	M40	1 1/4"	N125	3	27.0 - 41.0	29.0	34.0	60	2.0	55	55	92.0	10	ADE6CM403NPSCN	ADE6CN1253NPSCN
ADE6C	50	M50	1 1/2"	N150	2	27.0 - 41.0	29.0	34.0	60	2.0	55	55	92.0	10	ADE6CM502NPSCN	ADE6CN1502NPSCN
ADE6C	50	M50	2"	N200	1	33.0 - 48.0	36.5	41.0	80	2.5	64	64	104.0	11	ADE6CM501NPSCN	ADE6CN2001NPSCN
ADE6C	63	M63	2"	N200	2	40.0 - 56.0	43.0	48.0	100	2.5	72	72	108.0	12	ADE6CM632NPSCN	ADE6CN2002NPSCN
ADE6C	63	M63	2"	N200	3	46.0 - 65.0	50.0	56.0	100	2.5	85	85	118.0	13	ADE6CM633NPSCN	ADE6CN2003NPSCN
ADE6C	75	M75	2 1/2"	N250	2	46.0 - 65.0	50.0	56.0	100	2.5	85	85	118.0	13	ADE6CM752NPSCN	ADE6CN2502NPSCN
ADE6C	75	M75	2 1/2"	N250	3	54.0 - 74.0	59.0	65.0	120	2.5	95	95	124.0	14	ADE6CM753NPSCN	ADE6CN2503NPSCN
ADE6C	-	-	3"	N300	1	54.0 - 74.0	59.0	65.0	120	2.5	95	95	124.0	14	-	ADE6CN3001NPSCN
ADE6C	90	M90	3"	N300	2	63.0 - 83.0	66.0	73.0	140	3.1	110	110	133.0	15	ADE6CM902NPSCN	ADE6CN3002NPSCN
ADE6C	-	-	3 1/2"	N350	2	63.0 - 83.0	66.0	73.0	140	3.1	110	110	133.0	15	-	ADE6CN3502NPSCN
ADE6C	90	M90	3"	N300	3	72.0 - 93.0	75.0	82.0	140	3.1	120	120	137.0	16	ADE6CM903NPSCN	ADE6CN3003NPSCN
ADE6C	-	-	3 1/2"	N350	3	72.0 - 93.0	75.0	82.0	140	3.1	120	120	137.0	16	-	ADE6CN3503NPSCN
ADE6C	110	M110	4"	N400	3	85.0 - 104.0	85.0	92.0	200	3.5	135	135	142.0	17	ADE6CM1103NPSCN	ADE6CN4003NPSCN

* Not UL certified. All dimensions in mm. Above catalog numbers are for nickel-plated brass with neoprene seal; refer to order code diagram for other options.

If the material number (CAP) is required, please refer to pages 89-91.

Capri ADE Cable Glands - Accessories & Kits

ADE External Clamping Module - available with all ADE range



SELECTION TABLE					CATALOG NUMBER
CABLE RANGE	SIZE	FOR HEXAGON	WIDTH	THICKNESS	
2.8 - 5.5	3	15	18.0	5.0	CAP810334
4.0 - 8.5	4	17	20.0	5.0	CAP810444
6.0 - 11.0	5	19	22.0	5.0	CAP810534
8.5 - 16.0	6	24	27.5	6.0	CAP810634
12.0 - 21.0	7	30	33.5	8.0	CAP810734
16.0 - 27.5	8	41	45.0	8.0	CAP810834
21.0 - 34.0	9	48	52.0	9.5	CAP810934
27.0 - 41.0	10	55	59.0	9.5	CAP811034
33.0 - 48.0	11	64	69.0	12.0	CAP811134
40.0 - 56.0	12	72	78.0	12.0	CAP811234
47.0 - 65.0	13	85	92.0	16.0	CAP811334
54.0 - 74.0	14	95	103.0	16.0	CAP811434
63.0 - 83.0	15	110	118.0	18.0	CAP811534
72.0 - 93.0	16	120	128.0	18.0	CAP811634

ADE clamping module – material: nickel-plated brass and stainless steel washer and screws.
All dimensions in mm.

ADE 4F and 5F Lead Sheath Washer



SELECTION TABLE			CATALOG NUMBER
GLAND SIZE	OUTER LEAD SHEATH		
	MIN	MAX	
5	4.5	7.5	CAP560530
6	7.0	11.0	CAP560630
7	10.0	15.0	CAP560730
8	13.5	20.0	CAP560830
9	18.0	26.5	CAP560930
10	23.0	32.5	CAP561030
11	29.0	39.5	CAP561130
12	35.0	46.5	CAP561230
13	42.0	54.5	CAP561330
14	50.0	61.0	CAP561430
15	58.0	72.5	CAP561530
16	66.0	81.5	CAP561630

ADE 4F and 5F lead sheath washer – material: natural brass.
All dimensions in mm.

ADE - CAP Standard Kits

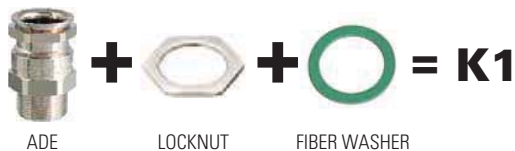

K1, K2 and K3 kits are available for all of the ADE range.
K1 kits are also suitable for the NEWCAP range.

Technical Note:

NPT kits are available; however, please note the following guidelines:
IEC 60079-14 Ed. 4.0 - Section 9.3.10 Connections of Cables to Equipment.
Cable glands with tapered threads shall not be used in enclosures having gland plates with unthreaded entries.

Capri - Accessories

ISO - METRIC SELECTION TABLE			
GASKET			GREEN FIBER CATALOG NUMBER
THREAD SIZE	D	E THICKNESS	
10	15.0	1.2	CAP221045
12	18.0	1.2	CAP221245
16	22.0	1.2	CAP221645
20	27.0	1.2	CAP222045
25	35.0	1.5	CAP222545
32	43.0	1.5	CAP223245
40	55.0	1.5	CAP224045
50	69.0	1.5	CAP225045
63	82.0	2.0	CAP226345
75	95.0	2.0	CAP227545
90	110.0	2.0	CAP229045
110	130.0	2.0	CAP221145

All dimensions in mm.
Outer diameter dimensions may be subject to change.

NPT - SELECTION TABLE			
GASKET			GREEN FIBER CATALOG NUMBER
THREAD SIZE	D	E THICKNESS	
1/4"	18.0	1.5	CAP239014
3/8"	22.0	1.5	CAP239038
1/2"	31.0	1.5	CAP239012
3/4"	35.0	1.5	CAP239034
1"	43.0	1.5	CAP239010
1 1/4"	59.0	1.5	CAP239114
1 1/2"	69.0	1.5	CAP239112
2"	79.0	2.0	CAP239020
2 1/2"	94.0	2.0	CAP239212
3"	110.0	2.0	CAP239300
3 1/2"	119.0	2.0	CAP239312
4"	130.0	2.0	CAP239414

All dimensions in mm.
Outer diameter dimensions may be subject to change.

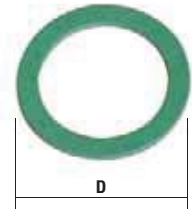

ISO - METRIC SELECTION TABLE			
GASKET			NEOPRENE CATALOG NUMBER
THREAD SIZE	D	E THICKNESS	
10	15.0	1.2	CAP221049
12	18.0	1.2	CAP221249
16	22.0	1.2	CAP221649
20	24.0	1.2	CAP222049
25	30.0	1.5	CAP222549
32	42.0	1.5	CAP223249
40	52.0	1.5	CAP224049
50	63.0	1.5	CAP225049
63	77.0	2.0	CAP226349
75	90.0	2.0	CAP227549
90	106.0	2.0	CAP229049
110	126.0	2.0	CAP221149

All dimensions in mm.
Outer diameter dimensions may be subject to change.

NPT - SELECTION TABLE			
GASKET			NEOPRENE CATALOG NUMBER
THREAD SIZE	D	E THICKNESS	
1/4"	20.0	1.5	CAP229014
3/8"	22.0	1.5	CAP229038
1/2"	27.0	1.5	CAP229012
3/4"	33.0	1.5	CAP229034
1"	41.0	1.5	CAP229010
1 1/4"	52.0	1.5	CAP229114
1 1/2"	57.0	1.5	CAP229112
2"	71.0	2.0	CAP229020
2 1/2"	85.0	2.0	CAP229212
3"	104.0	2.0	CAP229300
3 1/2"	120.0	2.0	CAP229312
4"	130.0	2.0	CAP229414

All dimensions in mm.
Outer diameter dimensions may be subject to change.

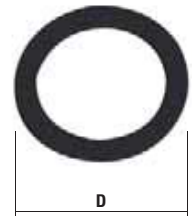

ISO - METRIC SELECTION TABLE			
GASKET			RED FIBER CATALOG NUMBER
THREAD SIZE	D	E THICKNESS	
10	18.6	1.5	CAP221041
12	22.0	1.5	CAP221241
16	25.0	1.5	CAP221641
20	28.7	1.5	CAP222041
25	36.0	1.5	CAP222541
32	42.5	1.5	CAP223241
40	52.0	1.5	CAP224041
50	65.0	1.5	CAP225041
63	79.4	1.5	CAP226341
75	90.5	1.5	CAP227541
90	114.3	1.5	CAP229041
110	135.0	1.5	CAP221141

All dimensions in mm.
Outer diameter dimensions may be subject to change.

NPT - SELECTION TABLE			
GASKET			RED FIBER CATALOG NUMBER
THREAD SIZE	D	E THICKNESS	
1/4"	20.4	1.5	CAP219014
3/8"	22.0	1.5	CAP219038
1/2"	30.0	1.5	CAP219012
3/4"	38.0	1.5	CAP219034
1"	46.0	1.5	CAP219010
1 1/4"	55.5	1.5	CAP219114
1 1/2"	58.8	1.5	CAP219112
2"	79.4	1.5	CAP219020
2 1/2"	90.5	1.5	CAP219212
3"	114.3	1.5	CAP219300
3 1/2"	114.3	1.5	CAP219312
4"	146.0	1.5	CAP219414

All dimensions in mm.
Outer diameter dimensions may be subject to change.

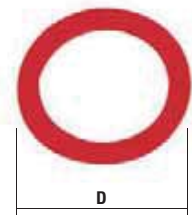

Capri - Accessories

WHITE NYLON WASHERS			
GASKET			WHITE NYLON CATALOG NUMBER
THREAD SIZE	D	E THICKNESS	
12	22.0	1.5	CAP221242
16	25.0	1.5	CAP221642
20	28.7	1.5	CAP222042
25	36.0	1.5	CAP222542
32	42.5	1.5	CAP223242
40	52.0	1.5	CAP224042
50	65.0	1.5	CAP225042
63	79.4	1.5	CAP226342
75	90.5	1.5	CAP227542
80	104.8	1.5	CAP228042
90	114.3	1.5	CAP229042
100	114.3	1.5	CAP229942
110	135.0	1.5	CAP221142

All dimensions in mm.
Outer diameter dimensions may be subject to change.

PTFE WASHERS			
GASKET			PTFE CATALOG NUMBER
THREAD SIZE	D	E THICKNESS	
12	22.0	1.5	CAP221243
16	25.0	1.5	CAP221643
20	28.7	1.5	CAP222043
25	36.0	1.5	CAP222543
32	42.5	1.5	CAP223243
40	52.0	1.5	CAP224043
50	65.0	1.5	CAP225043
63	79.4	1.5	CAP226343
75	90.5	1.5	CAP227543
80	104.8	1.5	CAP228043
90	114.3	1.5	CAP229043
100	114.3	1.5	CAP229943
110	135.0	1.5	CAP221143

All dimensions in mm.
Outer diameter dimensions may be subject to change.

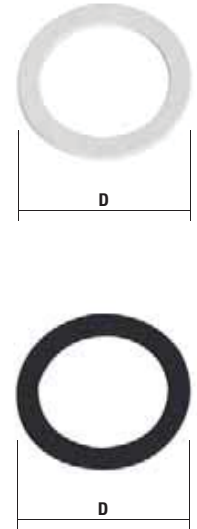

ISO - METRIC SELECTION TABLE		
LOCKNUT	NICKEL-PLATED BRASS	316L STAINLESS STEEL
THREAD SIZE	CATALOG NUMBER	CATALOG NUMBER
16	CAP221694	CAP221699
20	CAP222094	CAP222099
25	CAP222594	CAP222599
32	CAP223294	CAP223299
40	CAP224094	CAP224099
50	CAP225094	CAP225099
63	CAP226394	CAP226399
75	CAP227594	CAP227599
90	CAP229094	CAP229099
110	CAP221104	CAP221109

NPT - SELECTION TABLE		
LOCKNUT	NICKEL-PLATED BRASS	316L STAINLESS STEEL
THREAD SIZE	CATALOG NUMBER	CATALOG NUMBER
1/2"	CAP280124	CAP280129
3/4"	CAP280134	CAP280139
1"	CAP280144	CAP280149
1 1/4"	CAP280154	CAP280159
1 1/2"	CAP280164	CAP280169
2"	CAP280174	CAP280179
2 1/2"	CAP280184	CAP280189
3"	CAP280194	CAP280199
3 1/2"	CAP280204	CAP280209
4"	CAP280214	CAP280219



ISO - METRIC SELECTION TABLE						
EARTH TAG				NICKEL-PLATED BRASS CATALOG NUMBER	316L STAINLESS STEEL CATALOG NUMBER	
THREAD SIZE	A	B	C D			
16	48.5	30.0	6.5 24.5	CAP567034	CAP567039	
20	53.8	33.0	7.0 28.6	CAP567054	CAP567059	
25	61.5	36.0	10.5 34.0	CAP567074	CAP567079	
32	73.0	41.0	12.2 42.0	CAP567094	CAP567099	
40	86.5	44.5	13.5 54.0	CAP567124	CAP567129	
50	111.5	58.0	13.5 67.0	CAP567154	CAP567159	
63	125.5	67.0	13.5 77.0	CAP567184	CAP567189	
75	137.5	73.0	13.5 89.0	CAP567194	CAP567199	
90	167.0	93.0	13.5 109.5	CAP567214	CAP567219	
110	214.0	125.0	13.5 138.0	CAP567234	CAP567239	

All dimensions in mm.

NPT - SELECTION TABLE						
EARTH TAG				NICKEL-PLATED BRASS CATALOG NUMBER	316L STAINLESS STEEL CATALOG NUMBER	
THREAD SIZE	A	B	C D			
1/2"	61.5	33.0	10.5 28.6	CAP567064	CAP567069	
3/4"	73.0	36.0	12.2 34.0	CAP567084	CAP567089	
1"	73.0	41.0	12.2 42.0	CAP567104	CAP567109	
1 1/4"	86.5	44.5	13.5 54.0	CAP567134	CAP567139	
1 1/2"	111.5	58.0	13.5 67.0	CAP567154	CAP567159	
2"	125.5	67.0	13.5 77.0	CAP567174	CAP567179	
2 1/2"	137.5	73.0	13.5 89.0	CAP567194	CAP567199	
3"	167.0	93.0	13.5 109.5	CAP567214	CAP567219	
3 1/2"	188.0	107.3	13.5 121.5	CAP567224	CAP567229	
4"	214.0	125.0	13.5 138.0	CAP567244	CAP567249	

All dimensions in mm.

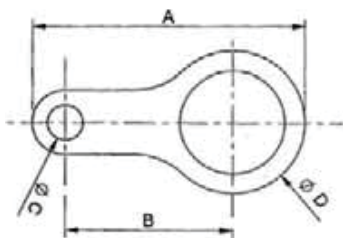

Capri - Accessories

ISO - METRIC SELECTION TABLE		
SERRATED WASHER		GALVANIZED STEEL CATALOG NUMBER
THREAD SIZE	D	
16	25.5	CAP280016
20	32.5	CAP280020
25	39.5	CAP280025
32	49.5	CAP280032
40	64.5	CAP280040
50	80.5	CAP280050
63	100.0	CAP280063
75	112.0	CAP280075
90	123.0	CAP280090

All dimensions in mm.

ISO - METRIC SELECTION TABLE		
SERRATED WASHER		316L STAINLESS STEEL CATALOG NUMBER
THREAD SIZE	D	
16	25.5	CAP280069
20	32.5	CAP280029
25	39.5	CAP280259
32	49.5	CAP280329
40	64.5	CAP280409
50	80.5	CAP280509
63	100.0	CAP280639
75	112.0	CAP280759
90	123.0	CAP280099

All dimensions in mm.



SELECTION TABLE		
SHROUD		PVC CATALOG NUMBER
ADE SIZE	DIAMETER A	
4	16.0	CAP506040
5	20.0	CAP506050
6	25.0	CAP506060
7	31.0	CAP506070
8	43.0	CAP506080
9	52.0	CAP506090
10	59.0	CAP506100
11	67.0	CAP506110
12	75.0	CAP506120
13	90.0	CAP506130
14	100.0	CAP506140
15	116.0	CAP506150
16	127.0	CAP506160

All dimensions in mm.



HTL (High Temperature Thread Lubricant)	
SIZE	CATALOG NUMBER
4.0 oz	CAP023836

HTL is a high temperature, anti-seize, conductive thread lubricant:

- Effective and stable from -70°F to +1800°F
- Prevents seizure, galling, rust, galvanic action
- Maintains grounding continuity; should not be used on exposed current-carrying parts
- Effective between parts made of dissimilar metals



CAPRI COMPOUND	
SIZE	CATALOG NUMBER
0.5 oz	CAP560001
1.0 oz	CAP560002
4.0 oz	CAP560003

For use with ADE 1FC and ADE 6FC cable glands.



Technical Specification



Suitable for the following cable types

- Non-armoured cable
- Braided cable

Certifications and Compliances

Zones 1 and 2, Group IIC

Zones 21 and 22, Group IIIC

ATEX Certificate No.: INERIS 13ATEX0008X

Ex eb IIC, Ex nRc IIC, Ex tb IIIC

IECEX Certificate No.: IECEX INE 13.0003X

Product Specification

Material:

Nickel-plated brass for superior corrosion resistance.
 316 stainless steel long fixing thread option available.
 It is recommended that a suitable lubricant is used on all threads of stainless steel and aluminum versions.

Operating Temperature:

- Neoprene seal: -20°C to +80°C

Ingress Protection (IP)

- IP66/IP68 tested 30m/7days on surface Ra 1.6µm max.

Accessory kit available; see page 30 for details.

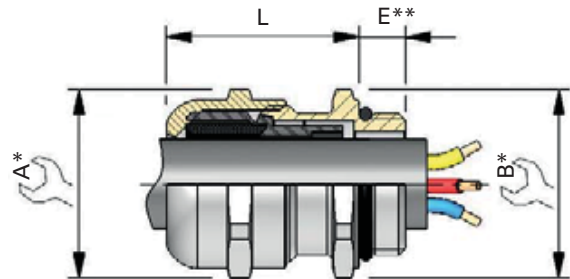

* For 'across corners' dimensions, multiply 'across flats' dimensions by 1.1

** For 'E' see Thread Dimension page 87

SELECTION TABLE		DIMENSIONS				GLAND SIZE	CATALOG NUMBER ISO (NICKEL-PLATED BRASS)	CATALOG NUMBER ISO (316 STAINLESS STEEL LONG FIXING THREAD)
THREAD SIZE ISO	BRAID THICKNESS	CABLE DIAMETER MIN - MAX	A	B	L (LENGTH)			
12	0.70	4.0 - 6.5	15	15	18	4	CAP192124V1	CAP192129V1
16	0.70	4.0 - 6.5	15	18	18	4	CAP192154V1	CAP192159V1
16	0.70	5.5 - 10.0	20	20	24	5	CAP192164V1	CAP192169V1
20	0.70	5.5 - 10.0	20	22	24	5	CAP192194V1	CAP192199V1
20	0.80	7.5 - 13.0	24	24	27	6	CAP192204V1	CAP192209V1
25	0.80	7.5 - 13.0	24	27	27	6	CAP192244V1	CAP192249V1
25	0.85	11.5 - 18.0	30	30	28	7	CAP192254V1	CAP192259V1
32	0.85	11.5 - 18.0	30	34	28	7	CAP192314V1	CAP192319V1
32	0.95	17.5 - 24.5	38	38	30	8	CAP192324V1	CAP192329V1
40	0.95	17.5 - 24.5	38	43	30	8	CAP192394V1	CAP192399V1
40	1.00	24.0 - 32.0	47	47	33	9	CAP192404V1	CAP192409V1
50	1.00	24.0 - 32.0	47	54	33	9	CAP192494V1	CAP192499V1
50	1.15	31.0 - 40.5	57	57	37	10	CAP192504V1	CAP192509V1
63	1.15	31.0 - 40.5	57	68	37	10	CAP192624V1	CAP192629V1
63	1.75	39.0 - 53.0	75	75	48	11	CAP192634V1	CAP192639V1

All dimensions in mm.

Technical Specification



Suitable for the following cable types

- Non-armoured cable
- Shielded cable for EMC specific cable and applications

Certifications and Compliances

Zones 1 and 2, Group IIC

Zones 21 and 22, Group IIIC

ATEX Certificate No.: INERIS 13ATEX0008X

Ex eb IIC, Ex nRc IIC, Ex tb IIIC

IECEx Certificate No.: IECEx INE 13.0003X

Product Specification

Material:

Nickel-plated brass for superior corrosion resistance.
316 stainless steel long fixing thread option available.
It is recommended that a suitable lubricant is used on all threads of stainless steel and aluminum versions.

Operating Temperature:

- Neoprene seal: -20°C to +80°C

Ingress Protection (IP)

- IP66/IP68 tested 30m/7days on surface Ra 1.6µm max.

Accessory kit available; see page 30 for details.

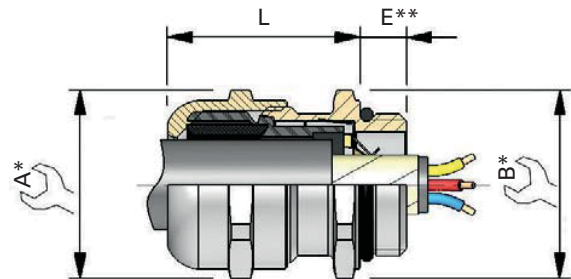

* For 'across corners' dimensions, multiply 'across flats' dimensions by 1.1

** For 'E' see Thread Dimension page 87

SELECTION TABLE		DIMENSIONS					GLAND SIZE	CATALOG NUMBER ISO (NICKEL-PLATED BRASS)	CATALOG NUMBER ISO (316 STAINLESS STEEL LONG FIXING THREAD)
THREAD SIZE	BRAID THICKNESS	DIAMETER ON SHIELD	CABLE DIAMETER MIN - MAX	A	B	L (LENGTH)			
ISO									
12	0.70	3.0	4.0 - 6.5	15	15	18	4	CAP193124V1	CAP193129V1
16	0.70	3.0	4.0 - 6.5	15	18	18	4	CAP193154V1	CAP193159V1
16	0.70	4.5	5.5 - 10.0	20	20	24	5	CAP193164V1	CAP193169V1
20	0.70	4.5	5.5 - 10.0	20	22	24	5	CAP193194V1	CAP193199V1
20	0.80	6.0	7.5 - 13.0	24	24	27	6	CAP193204V1	CAP193209V1
25	0.80	6.0	7.5 - 13.0	24	27	27	6	CAP193244V1	CAP193249V1
25	0.85	10.0	11.5 - 18.0	30	30	28	7	CAP193254V1	CAP193259V1
32	0.85	10.0	11.5 - 18.0	30	34	28	7	CAP193314V1	CAP193319V1
32	0.95	15.0	17.5 - 24.5	38	38	30	8	CAP193324V1	CAP193329V1
40	0.95	15.0	17.5 - 24.5	38	43	30	8	CAP193394V1	CAP193399V1
40	1.00	20.5	24.0 - 32.0	47	47	33	9	CAP193404V1	CAP193409V1
50	1.00	20.5	24.0 - 32.0	47	54	33	9	CAP193494V1	CAP193499V1
50	1.15	27.5	31.0 - 40.5	57	57	37	10	CAP193504V1	CAP193509V1
63	1.15	27.5	31.0 - 40.5	57	68	37	10	CAP193624V1	CAP193629V1
63	1.75	34.5	39.0 - 53.0	75	75	48	11	CAP193634V1	CAP193639V1

All dimensions in mm.

Capri EXACAP Ex-e & Ex-i / CEAG GHG Ex-e & Ex-i

Technical Specification



Suitable for the following cable types

- Non-armoured cable

Certifications and Compliances

ATEX Certificate No.: PTB 99 ATEX 3101X (M12-M16 only)

No.: PTB 99 ATEX 3128X (M20-M63 only)

II 2 G Ex e II / II 2 D Ex tD A21 IP66

IECEX Certificate No.: IECEX PTB 05.0004X

Product Specification

Material:

Nylon material.

Large cable connection area.

Low torque required for tightening.

Integrated sealing lip on thread.

Operating Temperature:

- ATEX/IECEX Certification: -20°C to +70°C

Ingress Protection (IP)

- IP66

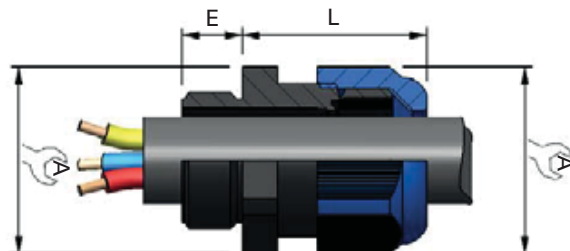

SELECTION TABLE		DIMENSIONS			GLAND SIZE	CAPRI CATALOG NUMBER Ex-e (BLACK)	CAPRI CATALOG NUMBER Ex-i (BLUE)	CEAG CATALOG NUMBER ISO Ex-e (BLACK)	CEAG CATALOG NUMBER ISO Ex-i (BLUE)
THREAD SIZE ISO	CABLE DIAMETER MIN - MAX	A	E THREAD LENGTH	L (LENGTH)					
Ex-e / Ex-i Glands with Short Thread									
12	4.0 - 7.0	15.0	8.0	19.3	4	CAP451207	CAP451206	GHG 960 1955 R 0001	GHG 960 1955 R0101
16	5.5 - 10.0	20.0	8.0	23.0	6	CAP451607	CAP451606	GHG 960 1955 R 0002	GHG 960 1955 R0102
20	5.5 - 13.0	24.0	8.0	25.0	7	CAP452007	CAP452006	GHG 960 1955 R 0003	GHG 960 1955 R0103
25	8.0 - 17.0	29.0	8.0	29.5	9	CAP452507	CAP452506	GHG 960 1955 R 0004	GHG 960 1955 R0104
32	12.0 - 21.0	36.0	10.0	35.5	10	CAP453207	CAP453206	GHG 960 1955 R 0005	GHG 960 1955 R0105
Ex-e / Ex-i Glands with Long Thread									
12	4.0 - 7.0	15.0	12.0	19.3	4	CAP451217	CAP451216	GHG 960 1955 R 0021	GHG 960 1955 R0121
16	5.5 - 10.0	20.0	12.0	23.0	6	CAP451617	CAP451616	GHG 960 1955 R 0022	GHG 960 1955 R0122
20	5.5 - 13.0	24.0	13.0	25.0	7	CAP452017	CAP452016	GHG 960 1955 R 0023	GHG 960 1955 R0123
25	8.0 - 17.0	29.0	13.0	29.5	9	CAP452517	CAP452516	GHG 960 1955 R 0024	GHG 960 1955 R0124
32	12.0 - 21.0	36.0	15.0	35.5	10	CAP453217	CAP453216	GHG 960 1955 R 0025	GHG 960 1955 R0125
40	17.0 - 28.0	46.0	15.0	39.5	11	CAP454017	CAP454016	GHG 960 1955 R 0026	GHG 960 1955 R0126
50	22.0 - 35.0	55.0	16.0	44.0	12	CAP455017	CAP455016	GHG 960 1955 R 0027	GHG 960 1955 R0127
63	27.0 - 48.0	68.0	16.0	47.0	13	CAP456317	CAP456316	GHG 960 1955 R 0028	GHG 960 1955 R0128

All dimensions in mm.

Technical Specification



Suitable for the following cable types

- Non-armoured cable

Certifications and Compliances

PTB 00 ATEX 3121 X
Ex II 2 G Ex e II / Ex II 2 D Ex tD A21

Product Specification

Material:

Nylon material.
Large cable connection area.
Low torque required for tightening.
Integrated sealing lip on thread.

Operating Temperature:

- 40°C to +85°C

Ingress Protection (IP)

- IP66

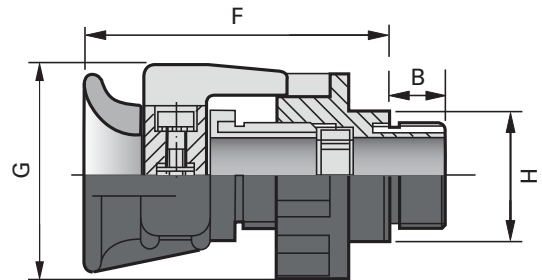

SELECTION TABLE		DIMENSIONS					CATALOG NUMBER
GLAND SIZE	METRIC SIZE	GLAND LENGTH 'F' (LESS ENTRY)	OUTER SHEATH MIN - MAX	ACROSS FLATS 'H'	ACROSS CORNERS 'G'	THREAD LENGTH 'B'	
ISO							
20	M20	49.0	8.0 - 13.0	26.0	28.6	15.0	GHG 960 1949 R0111
25	M25	50.0	11.0 - 16.0	32.0	35.2	15.0	GHG 960 1949 R0112
32	M32	65.0	15.0 - 20.0	41.0	45.1	15.0	GHG 960 1949 R0113
40	M40	71.0	19.0 - 27.0	50.0	55.0	15.0	GHG 960 1949 R0114
50	M50	79.0	26.0 - 34.0	60.0	66.0	16.0	GHG 960 1949 R0115
63	M63	89.0	35.0 - 46.0	75.0	82.5	16.0	GHG 960 1949 R0116

All dimensions in mm.

Terminator™ II TMCX - for Armoured/Non-armoured Cable

Technical Specification



Suitable for the following cable types

- Metal-clad and TECK (interlocked and continuously welded corrugated armoured) cable
- Unarmoured and tray cable – TC, TC-ER (HL)

Certifications and Compliances

- Class I, Division 1, Groups A, B, C, D
- Class II, Groups E, F, G
- Class III
- Class I, Zone 1, Group IIC
- NEMA 6P (1/2" to 1-1/4" size 1)
- NEMA 4 (1-1/4" size 2 to 4")
- UL/cULus Listed - File No. E122485

Product Specification

Material:

Aluminum as standard material with neoprene seal.
 316 stainless steel and nickel-plated brass construction available.
 Chico® LiquidSeal liquid compound with fast gel and cure times to reduce waiting time. Also available with regular TSC putty compound.

Operating Temperature:

- -40°C to +60°C
- For specific temperature information, please contact your local sales representative.



Chico® LiquidSeal

- Mixing time: 2 minutes
- Application: pour/gun
- Gel time: 15-30 minutes*
- Full cure/return to service time: 2 hours*
- Available for installation in vertical position
- Integral dam means no packing or taping to prevent liquid leakage

*At 20°C ambient temperature.

CATALOG NUMBER	SIZE (ml.)	STANDARD CARTON QUANTITY
LSC 10	10 ml.	10
LSC 20	20 ml.	10
LSC 75	75 ml.	5

TSC Epoxy Compound

- Mixing time: 5 minutes
- Application: by hand
- Full cure time: 24 hours
- Available for installation in any orientation



CATALOG NUMBER	TUBE SIZE (oz.)	STANDARD CARTON QUANTITY
TSC05	0.5 oz.	10
TSC1	1.0 oz.	10
TSC4	4.0 oz.	5



Features & Benefits

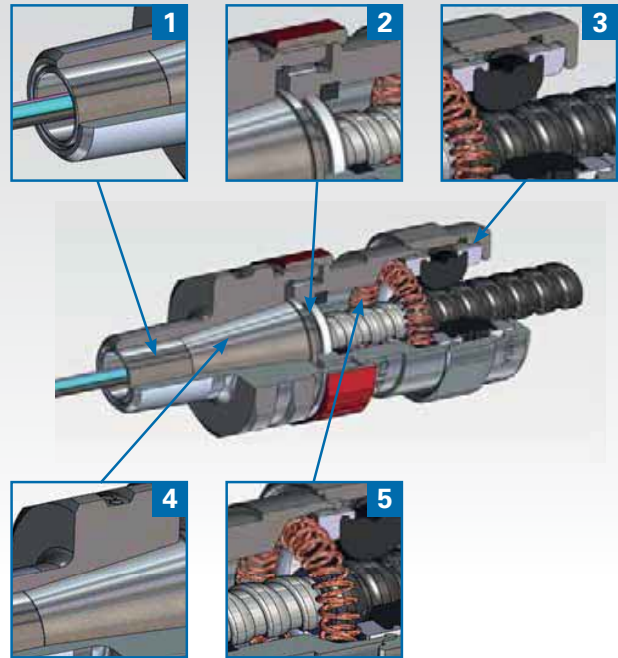

- 1: Choice of liquid or putty compound allows rapid curing and facilitates non-vertical applications. Includes compound dam.
- 2: Spined shaft ensures the two assemblies lock together and do not rotate, preventing need for two tools to be used.
- 3: Back nut/cap nut and environmental seal are captive, retaining entry end components.
- 4: Conical compound chamber ensures perfect flame path every time.
- 5: Integral union allows for a two-piece assembly gland, minimizing tightening and loosening of nuts, improving assembly time. Red anodized union nut is visible in any orientation for quick identification of Ex gland.

Terminator™ II TMCX - for Armoured/Non-armoured Cable

Dimensions

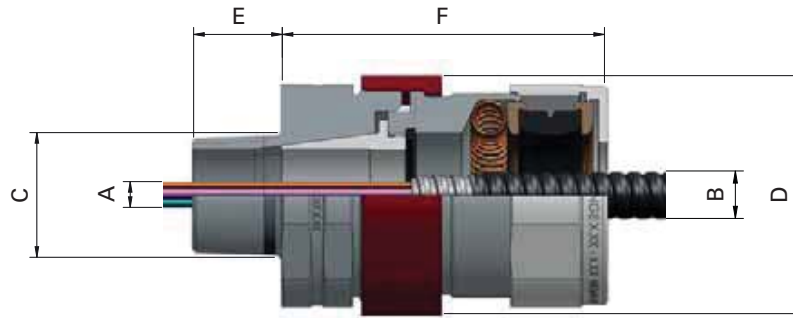

SERIES	THREAD SIZE	CABLE SEALING RANGE	MATERIAL	SEALING TYPE	VARIANT CODES	
TMCX	050	1	NP	L	L	Liquid Compound
					BLANK	TSC Compound
					NP	Nickel-plated Brass
					SS	Stainless Steel
					BLANK	Aluminum

SELECTION TABLE					DIMENSIONS						CATALOG NUMBER NPT	CATALOG NUMBER ISO
THREAD SIZE 'C'	THREAD SIZE CODE	THREAD SIZE 'C'	THREAD SIZE CODE	CABLE SEALING RANGE	CABLE SEALING RANGE ISO/(NPT)		ACROSS CORNERS 'D'	LENGTH 'F'	THREAD LENGTH 'E' NPT	THREAD LENGTH 'E' ISO		
NPT		ISO			ARMOUR RANGE 'A' MIN - MAX	OUTER SHEATH 'B' MIN - MAX						
1/2"	050	20	M20	1	0.40 - 0.86	0.49 - 0.90	1.75	3.05	1.00	25.40	TMCX050 1	TMCXM20 1
1/2"	050	20	M20	2	0.56 - 1.14	0.65 - 1.18	2.25	3.18	1.00	25.40	TMCX050 2	TMCXM20 2
3/4"	075	25	M25	1	0.40 - 0.86	0.49 - 0.90	1.75	3.05	1.00	25.40	TMCX075 1	TMCXM25 1
3/4"	075	25	M25	2	0.56 - 1.14	0.65 - 1.18	2.25	3.18	1.00	25.40	TMCX075 2	TMCXM25 2
1"	100	32	M32	1	0.56 - 1.14	0.65 - 1.18	2.25	3.18	1.08	27.40	TMCX100 1	TMCXM32 1
1"	100	32	M32	2	0.78 - 1.35	0.87 - 1.39	2.56	3.30	1.08	27.40	TMCX100 2	TMCXM32 2
1 1/4"	125	40	M40	1	0.78 - 1.35	0.87 - 1.39	2.56	3.30	1.08	27.40	TMCX125 1	TMCXM40 1
1 1/4"	125	40	M40	2	0.94 - 1.67	1.03 - 1.65	3.73	4.71	1.25	31.75	TMCX125 2	TMCXM40 2
1 1/2"	150	50	M50	1	0.94 - 1.67	1.03 - 1.65	3.73	4.71	1.25	31.75	TMCX150 1	TMCXM50 1
1 1/2"	150	50	M50	2	1.28 - 1.97	1.53 - 2.07	4.11	4.71	1.25	31.75	TMCX150 2	TMCXM50 2
2"	200	63	M63	1	1.28 - 1.97	1.53 - 2.07	4.11	4.71	1.25	31.75	TMCX200 1	TMCXM63 1
2"	200	63	M63	2	1.67 - 2.62	1.81 - 2.72	4.98	5.63	1.25	31.75	TMCX200 2	TMCXM63 2
2 1/2"	250	75	M75	1	1.67 - 2.62	1.81 - 2.72	4.98	5.63	1.81	45.97	TMCX250 1	TMCXM75 1
2 1/2"	250	75	M75	2	2.11 - 2.95	2.34 - 3.13	5.61	5.80	1.81	45.97	TMCX250 2	TMCXM75 2
3"	300	90	M90	1	2.11 - 2.95	2.34 - 3.13	5.61	5.80	1.81	45.97	TMCX300 1	TMCXM90 1
3"	300	90	M90	2	2.45 - 3.39	2.68 - 3.61	6.23	6.26	1.81	45.97	TMCX300 2	TMCXM90 2
3 1/2"	350	110	M110	1	2.45 - 3.39	2.68 - 3.61	6.23	6.26	1.94	49.28	TMCX350 1	TMCXM110 1
3 1/2"	350	110	M110	2	3.05 - 4.22	3.13 - 3.97	6.73	6.52	1.94	49.28	TMCX350 2	TMCXM110 2
4"	400	-	-	1	2.45 - 3.39	2.68 - 3.61	6.23	6.26	2.00	50.80	TMCX400 1	-
4"	400	-	-	2	3.05 - 4.22	3.13 - 3.97	6.73	6.52	2.00	50.80	TMCX400 2	-

All dimensions in inches unless otherwise stated.

COLD SHRINK KIT	
TMCX II CATALOG NUMBER	COLD SHRINK KIT CATALOG NUMBER
TMCX050 1	TMC K3
TMCX050 2	TMC K4
TMCX075 1	TMC K3
TMCX075 2	TMC K4
TMCX100 1	TMC K4
TMCX100 2	TMC K5
TMCX125 1	TMC K5

Cold Shrink™ Corrosion Protection Kits are specially designed for Crouse-Hinds TMC, TMCX and TECK fittings to provide protection against corrosive elements like salt spray and moisture. The TMC-K kit is made of a Cold Shrink material that is quick and easy to install on the gland. The Cold Shrink material is made of EPDM rubber that contains no chlorides or sulphurs. The protection kit installs easily over the gland without the use of a heat source to shrink the material tightly over the seal. The Cold Shrink material can be removed easily from the gland by simply cutting it off.

Cold Shrink is a registered trademark of the 3M Company.

TMCX - for Armoured/Non-armoured Cable

Technical Specification



Suitable for the following cable types

- Metal-clad cable (interlocked or continuously welded corrugated armoured)
- Non-armoured cable
- TECK cable
- TECK hazardous locations cable (TECK HL)
- Tray cable

Certifications and Compliances

Class I, Division 1, Groups A, B, C, D
 Class II
 Class III
 UL Listed: E122485
 CSA Listed: LR13046

Product Specification

Material:

Aluminum as standard material with neoprene seal; brass and nickel-plated brass available as an option.
 Stainless steel copper-plated spring provides grounding continuity of cable armour (MC cable only).
 Provides explosionproof compound seal on conductors and watertight seal on outer sheath of cable.
 Cold Shrink™ Kit is available for extra protection in aggressive environments.

Operating Temperature:

- -25°C to +60°C

Ingress Protection (IP)

- IP56, NEMA 4

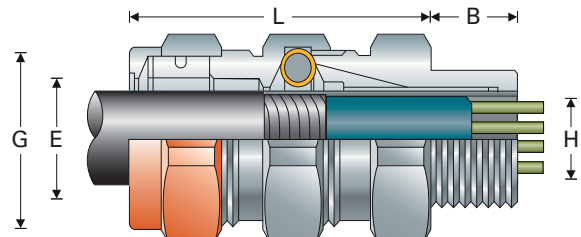

SELECTION TABLE		DIMENSIONS					CATALOG NUMBER ALUMINUM	COLD SHRINK KIT	
THREAD SIZE	ARMOUR RANGE 'H' MIN - MAX	OUTER SHEATH 'E' MIN - MAX	ACROSS FLATS	ACROSS CORNERS 'G'	L (LENGTH)	THREAD LENGTH 'B'		ENTRY THREAD	CATALOG NUMBER
NPT									
1/2"	0.44 - 0.65	0.49 - 0.78	1.25	1.38	2.63	0.75	TMCX165	1/2"	TMC K1
3/4"	0.60 - 0.85	0.65 - 1.00	1.50	1.63	2.88	0.78	TMCX285	3/4"	TMC K2
1"	0.80 - 1.12	0.85 - 1.31	1.88	2.00	3.13	0.94	TMCX3112	1"	TMC K3
1 1/4"	1.10 - 1.40	1.15 - 1.62	2.25	2.44	3.13	0.97	TMCX4140	1 1/4"	TMC K4
1 1/2"	1.33 - 1.61	1.38 - 1.78	2.50	2.75	3.38	0.97	TMCX5161	1 1/2"	TMC K5
2"	1.57 - 2.06	1.63 - 2.31	3.25	3.50	5.31	1.00	TMCX6206	2"	TMC K6
2 1/2"	1.93 - 2.47	1.99 - 2.72	3.75	4.00	6.06	1.44	TMCX7247	2 1/2"	TMC K7
3"	2.45 - 3.02	2.52 - 3.28	4.50	4.88	6.06	1.44	TMCX8302	3"	TMC K8
3 1/2"	2.95 - 3.52	3.02 - 3.78	5.00	5.38	7.75	1.63	TMCX9352	3 1/2"	TMC K9
4"	3.50 - 4.02	3.58 - 4.28	5.50	5.88	8.31	1.63	TMCX10402	4"	TMC K10

All dimensions in inches unless otherwise stated.

TMC - for Armoured/Non-armoured Cable

Technical Specification



Suitable for the following cable types

- Metal-clad cable (interlocked or continuously welded corrugated armoured)
- TECK cable
- Non-armoured cable
- Tray cable (not CSA)

Certifications and Compliances

UL Listed: UL File E36379
 CSA Listed: LR291
 NEMA 4 and IP56
 Wet Locations

Product Specification

Material:

Standard material is aluminum.
 Stainless steel copper-plated spring provides grounding continuity of cable armour (MC cable only).
 Watertight seal on outer sheath of cable.
 Standard neoprene seal suitable for use in operating temperatures -25° to +60°C.
 Cold Shrink™ Kit is available for extra protection in aggressive environments.
 Available with NPT threads.

Operating Temperature:

- -25°C to +60°C

Ingress Protection (IP)

- IP56, NEMA 4

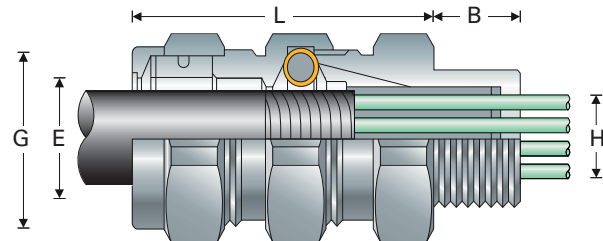

SELECTION TABLE		DIMENSIONS					CATALOG NUMBER ALUMINUM
THREAD SIZE	ARMOUR RANGE 'H' MIN - MAX	OUTER SHEATH 'E' MIN - MAX	ACROSS FLATS	ACROSS CORNERS 'G'	LENGTH 'L'	THREAD LENGTH 'B'	
NPT							
1/2"	0.44 - 0.65	0.49 - 0.78	1.25	1.38	2.38	0.75	TMC165
3/4"	0.60 - 0.85	0.65 - 1.00	1.50	1.63	2.63	0.78	TMC285
1"	0.80 - 1.12	0.85 - 1.31	1.88	2.00	3.13	0.94	TMC3112
1 1/4"	1.10 - 1.40	1.15 - 1.62	2.25	2.44	2.75	0.97	TMC4140
1 1/2"	1.33 - 1.61	1.38 - 1.78	2.50	2.75	3.38	0.97	TMC5161
2"	1.57 - 2.06	1.63 - 2.31	3.25	3.50	4.50	1.00	TMC6206
2 1/2"	1.93 - 2.47	1.99 - 2.72	3.75	4.00	4.75	1.44	TMC7247
3"	2.45 - 3.02	2.52 - 3.28	4.50	4.88	4.88	1.44	TMC8302
3 1/2"	2.95 - 3.52	3.02 - 3.78	5.00	5.38	5.38	1.63	TMC9352
4"	3.50 - 4.02	3.58 - 4.28	5.50	5.88	5.50	1.63	TMC10402

All dimensions in inches unless otherwise stated.

TECK - for TECK Armoured Cable

Technical Specification



Suitable for the following cable types

TECK armoured cable

Certifications and Compliances

- Class I
- Class II, Groups E, F, G
- Class III
- CSA Type 4
- CSA Listed: LR13046

Product Specification

Material:

Aluminum as standard material with neoprene seal; steel and stainless steel as an option.

Stainless steel copper-plated spring provides grounding continuity of cable armour (TECK cable only).

Provides watertight seal on outer sheath of cable.

Has integral o-ring seal on entry threads.

Cold Shrink™ Kit is available for extra protection in aggressive environments.

- Available with optional PVC coating in Canada. Refer to Plasti-Bond catalog

Operating Temperature:

- -25°C to +60°C

Ingress Protection (IP)

- IP56, Type 4

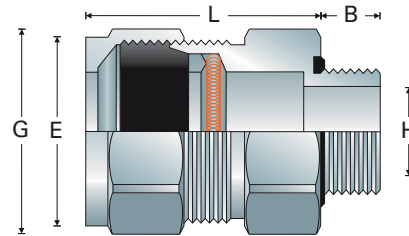

SELECTION TABLE		DIMENSIONS					CATALOG NUMBER ALUMINUM	CATALOG NUMBER STEEL	CATALOG NUMBER STAINLESS STEEL
THREAD SIZE	ARMOUR RANGE 'H' MIN - MAX	OUTER SHEATH 'E' MIN - MAX	ACROSS FLATS	ACROSS CORNERS 'G'	THREAD LENGTH 'B'	L (LENGTH)			
NPT									
1/2"	0.41 - 0.57	0.52 - 0.65	1.25	1.35	0.63	2.30	TECK050-1	TECK050-1S	TECK050-1SS
1/2"	0.49 - 0.68	0.60 - 0.76	1.38	1.50	0.63	2.30	TECK050-2	TECK050-2S	TECK050-2SS
1/2"	0.61 - 0.80	0.72 - 0.88	1.50	1.60	0.63	2.30	TECK050-3	TECK050-3S	TECK050-3SS
1/2"	0.71 - 0.90	0.82 - 0.98	1.50	1.60	0.63	2.30	TECK050-4	TECK050-4S	TECK050-4SS
3/4"	0.77 - 0.98	0.88 - 1.06	2.00	2.13	0.63	2.50	TECK075-5	TECK075-5S	TECK075-5SS
3/4"	0.91 - 1.12	1.02 - 1.20	2.00	2.13	0.63	2.50	TECK075-6	TECK075-6S	TECK075-6SS
1"	1.08 - 1.29	1.19 - 1.37	2.25	2.40	0.75	2.63	TECK100-7	TECK100-7S	TECK100-7SS
1 1/4"	1.24 - 1.54	1.35 - 1.62	3.00	3.13	0.80	3.50	TECK125-8	TECK125-8S	-
1 1/4"	1.39 - 1.54	1.50 - 1.62	3.00	3.13	0.80	3.40	TECK125-9	TECK125-9S	-
1 1/4"	1.49 - 1.79	1.60 - 1.87	3.00	3.13	0.80	3.50	TECK125-10	TECK125-10S	-
1 1/2"	1.59 - 1.88	1.70 - 1.96	3.75	3.60	0.80	3.80	TECK150-11	TECK150-11S	-
1 1/2"	1.79 - 2.11	1.90 - 2.19	3.50	3.75	0.80	3.90	TECK150-12	TECK150-12S	-
2"	1.79 - 2.11	1.90 - 2.19	3.75	4.00	0.82	4.00	TECK200-13	TECK200-13S	-
2"	1.99 - 2.28	2.10 - 2.37	3.75	4.00	0.82	4.00	TECK200-14	TECK200-14S	-
2"	2.19 - 2.48	2.30 - 2.56	4.13	4.40	0.87	4.00	TECK200-15	TECK200-15S	-
2"	2.39 - 2.66	2.50 - 2.75	4.13	4.40	0.87	4.00	TECK200-16	TECK200-16S	-
2 1/2"	2.24 - 2.56	2.38 - 2.64	4.50	4.75	1.30	5.00	TECK250-17	TECK250-17S	-
2 1/2"	2.24 - 2.75	2.58 - 2.84	4.50	4.75	1.30	5.00	TECK250-18	TECK250-18S	-
3"	2.64 - 2.97	2.79 - 3.06	4.60	4.90	1.40	5.00	TECK300-19	TECK300-19S	-
3"	2.87 - 3.19	3.00 - 3.27	4.90	5.25	1.40	5.00	TECK300-20	TECK300-20S	-
3"	3.04 - 3.39	3.21 - 3.48	5.00	5.25	1.40	5.00	TECK300-21	TECK300-21S	-
3 1/2"	3.27 - 3.59	3.42 - 3.69	5.60	5.90	1.40	5.00	TECK350-22	TECK350-22S	-
3 1/2"	3.44 - 3.77	3.61 - 3.87	5.50	5.90	1.40	5.00	TECK350-23	TECK350-23S	-
4"	3.60 - 3.93	3.81 - 4.03	6.13	6.50	1.40	5.00	TECK400-24	TECK400-24S	-
4"	3.75 - 4.06	3.96 - 4.18	6.13	6.50	1.40	5.00	TECK400-25	TECK400-25S	-
4"	3.91 - 4.22	4.12 - 4.34	6.13	6.50	1.40	5.00	TECK400-26	TECK400-26S	-

All dimensions in inches unless otherwise stated.

Thread Conversion Products & Accessories



Capri - Ex Certified Reducers/Adapters

REDUCER / ADAPTER - METRIC - SELECTION TABLE

MALE	FEMALE												
	M12	M16	M20	M25	M32	M40	M50	M63	M75	M80	M90	M100	M110
M12	CAP745324	CAP745334	CAP741034										
M16	CAP745834	CAP740014	CAP740274	CAP741064									
M20	CAP745844	CAP740024	CAP740284	CAP740544	CAP740804								
M25	CAP746594	CAP740034	CAP740294	CAP740554	CAP740814	CAP741134							
M32	CAP746604	CAP740044	CAP740304	CAP740564	CAP740824	CAP741084	CAP741914						
M40	CAP746614	CAP740054	CAP740314	CAP740574	CAP740834	CAP741094	CAP741354	CAP743644					
M50	CAP746624	CAP740064	CAP740324	CAP740584	CAP740844	CAP741104	CAP741364	CAP741624	CAP745114				
M63	CAP746634	CAP740074	CAP740334	CAP740594	CAP740854	CAP741114	CAP741374	CAP741634	CAP741894	CAP746944			
M75	CAP746644	CAP740084	CAP740344	CAP740604	CAP740864	CAP741124	CAP741384	CAP741644	CAP741904	CAP742414	CAP745394		
M80	CAP746654	CAP746694	CAP746734	CAP746774	CAP746814	CAP746414	CAP745824	CAP745754	CAP748074	CAP742424	CAP746074	CAP746334	
M90	CAP746664	CAP746704	CAP746744	CAP746784	CAP747914	CAP746854	CAP746384	CAP745854	CAP745864	CAP745464	CAP745474	CAP745484	CAP746344
M100	CAP746674	CAP746714	CAP747894	CAP746794	CAP747924	CAP746864	CAP746394	CAP746364	CAP745874	CAP746194	CAP745914	CAP745494	CAP745544
M110	CAP746684	CAP746724	CAP747904	CAP746804	CAP747934	CAP746874	CAP746404	CAP746374	CAP746354	CAP746204	CAP745924	CAP745934	CAP745564



REDUCER / ADAPTER - METRIC / NPT - SELECTION TABLE

MALE	FEMALE												
	1/4"	3/8"	1/2"	3/4"	1"	1 1/4"	1 1/2"	2"	2 1/2"	3"	3 1/2"	4"	
M12	CAP744104	CAP747794	CAP747804										
M16	CAP744184	CAP744194	CAP744694	CAP747814									
M20	CAP744204	CAP744214	CAP744704	CAP744964	CAP747824								
M25	CAP746884	CAP742954	CAP744714	CAP744974	CAP745234	CAP747834							
M32	CAP746894	CAP746984	CAP744724	CAP744984	CAP745244	CAP745504	CAP745764						
M40	CAP746904	CAP746994	CAP744734	CAP744994	CAP745254	CAP745514	CAP745774	CAP747844					
M50	CAP746914	CAP747004	CAP744744	CAP745004	CAP745264	CAP745524	CAP745784	CAP746044	CAP746304				
M63	CAP746924	CAP747014	CAP744754	CAP745014	CAP745274	CAP745534	CAP745794	CAP746054	CAP746314	CAP747854			
M75	CAP746934	CAP747024	CAP744764	CAP745024	CAP745284	CAP745544	CAP745804	CAP746064	CAP746324	CAP746584	CAP747864		
M80	CAP747884	CAP747034	CAP747074	CAP746514	CAP745294	CAP746474	CAP746434	CAP746114	CAP746144	CAP746184	CAP747874	CAP747874	
M90	CAP746954	CAP747044	CAP747084	CAP746524	CAP745304	CAP746554	CAP746444	CAP744284	CAP744294	CAP744304	CAP744314	CAP746264	
M100	CAP746964	CAP747054	CAP747094	CAP746534	CAP745314	CAP746564	CAP746454	CAP746124	CAP743134	CAP746034	CAP744434	CAP744444	
M110	CAP746974	CAP747064	CAP747104	CAP746544	CAP747114	CAP746574	CAP746464	CAP746134	CAP746174	CAP744514	CAP744524	CAP744534	



REDUCER / ADAPTER - NPT / NPT - SELECTION TABLE

MALE	FEMALE												
	1/4"	3/8"	1/2"	3/4"	1"	1 1/4"	1 1/2"	2"	2 1/2"	3"	3 1/2"	4"	
1/4"	CAP744574	CAP744584	CAP747704										
3/8"	CAP745574	CAP744614	CAP744624	CAP747714									
1/2"	CAP745584	CAP745594	CAP744874	CAP745134	CAP747724								
3/4"	CAP747124	CAP745604	CAP744884	CAP745144	CAP745404	CAP747734							
1"	CAP747134	CAP747214	CAP744894	CAP745154	CAP745414	CAP745674	CAP745814						
1 1/4"	CAP747144	CAP747224	CAP744904	CAP745164	CAP745424	CAP745684	CAP745944	CAP747744					
1 1/2"	CAP747154	CAP747234	CAP744914	CAP745174	CAP745434	CAP745694	CAP745954	CAP746214	CAP747754				
2"	CAP747164	CAP747244	CAP744924	CAP745184	CAP745444	CAP745704	CAP745964	CAP746224	CAP746484	CAP747764			
2 1/2"	CAP747174	CAP747254	CAP744934	CAP745194	CAP745454	CAP745714	CAP745974	CAP746234	CAP746494	CAP746754	CAP747774		
3"	CAP747184	CAP747264	CAP744944	CAP745204	CAP745464	CAP745724	CAP745984	CAP746244	CAP746504	CAP746764	CAP744634	CAP747784	
3 1/2"	CAP747194	CAP747274	CAP747314	CAP747334	CAP746094	CAP747354	CAP746284	CAP746254	CAP745654	CAP745664	CAP744644	CAP744654	
4"	CAP747204	CAP747284	CAP747324	CAP747344	CAP746104	CAP747364	CAP746294	CAP746824	CAP746274	CAP746834	CAP745734	CAP744774	



REDUCER / ADAPTER - NPT / ISO - SELECTION TABLE

MALE	FEMALE												
	M12	M16	M20	M25	M32	M40	M50	M63	M75	M80	M90	M100	M110
1/4"	CAP740614	CAP740624	CAP747624										
3/8"	CAP740884	CAP740894	CAP740904	CAP747634									
1/2"	CAP740914	CAP740194	CAP740454	CAP740714	CAP747644								
3/4"	CAP747374	CAP740204	CAP740464	CAP740724	CAP740984	CAP747654							
1"	CAP747384	CAP740214	CAP740474	CAP740734	CAP740994	CAP741254	CAP747664						
1 1/4"	CAP747394	CAP740224	CAP740484	CAP740744	CAP741004	CAP741264	CAP747674						
1 1/2"	CAP747404	CAP740234	CAP740494	CAP740754	CAP741014	CAP741274	CAP741534	CAP741794	CAP747684				
2"	CAP747414	CAP740244	CAP740504	CAP740764	CAP741024	CAP741284	CAP741544	CAP741804	CAP742064	CAP747694			
2 1/2"	CAP747424	CAP740254	CAP740514	CAP740774	CAP741144	CAP741294	CAP741554	CAP741814	CAP742074	CAP742074	CAP741154		
3"	CAP747434	CAP740264	CAP740524	CAP740784	CAP741044	CAP741304	CAP741564	CAP741824	CAP742084	CAP747594	CAP741244	CAP741314	
3 1/2"	CAP747444	CAP747464	CAP747484	CAP747504	CAP747524	CAP747544	CAP747564	CAP747584	CAP741434	CAP747604	CAP741444	CAP741454	CAP741494
4"	CAP747454	CAP747474	CAP747494	CAP747514	CAP747534	CAP747554	CAP747574	CAP742404	CAP742394	CAP747614	CAP741584	CAP741594	CAP741604



LAST CODE DIGIT 9: 316L Stainless Steel

LAST CODE DIGIT 7: Aluminum

Capri - Ex Certified Stopping Plugs

ISO - METRIC SELECTION TABLE		
STOPPING PLUG		NICKEL-PLATED BRASS CATALOG NUMBER
THREAD SIZE	E	
12	15.0	CAP190124
16	15.0	CAP190164
20	15.0	CAP190204
25	15.0	CAP190254
32	15.0	CAP190324
40	15.0	CAP190404
50	15.0	CAP190504
63	15.0	CAP190634
75	15.0	CAP190754
90	20.0	CAP199904
100	20.0	CAP191004
110	20.0	CAP191014

All dimensions in mm.

NPT - SELECTION TABLE		
STOPPING PLUG		NICKEL-PLATED BRASS CATALOG NUMBER
THREAD SIZE	E	
1/4"	15.5	CAP190194
3/8"	15.5	CAP190294
1/2"	20.2	CAP190394
3/4"	20.5	CAP190494
1"	25.3	CAP190594
1 1/4"	26.0	CAP190694
1 1/2"	26.5	CAP190794
2"	27.2	CAP190894
2 1/2"	40.5	CAP190994
3"	42.0	CAP191094
3 1/2"	43.2	CAP191194
4"	44.0	CAP191294

All dimensions in mm.



ISO - METRIC SELECTION TABLE		
STOPPING PLUG		316L STAINLESS STEEL CATALOG NUMBER
THREAD SIZE	E	
12	15.0	CAP190129
16	15.0	CAP190169
20	15.0	CAP190209
25	15.0	CAP190259
32	15.0	CAP190329
40	15.0	CAP190409
50	15.0	CAP190509
63	15.0	CAP190639
75	15.0	CAP190759
90	20.0	CAP199909
100	20.0	CAP191009
110	20.0	CAP191019

All dimensions in mm.

NPT - SELECTION TABLE		
STOPPING PLUG		316L STAINLESS STEEL CATALOG NUMBER
THREAD SIZE	E	
1/4"	15.5	CAP190199
3/8"	15.5	CAP109299
1/2"	20.2	CAP190399
3/4"	20.5	CAP190499
1"	25.3	CAP190599
1 1/4"	26.0	CAP190699
1 1/2"	26.5	CAP190799
2"	27.2	CAP190899
2 1/2"	40.5	CAP190999
3"	42.0	CAP191099
3 1/2"	43.2	CAP191199
4"	44.0	CAP191299

All dimensions in mm.

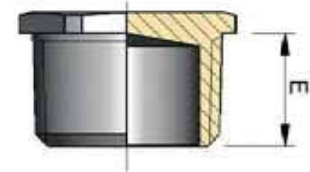

ISO - METRIC SELECTION TABLE				
STOPPING PLUG				POLYAMIDE CATALOG NUMBER
THREAD SIZE	A	L	E	
12	15	4.0	15	CAP191127
16	19	4.0	15	CAP191167
20	23	4.0	15	CAP191207
25	28	5.0	15	CAP191257
32	36	5.5	15	CAP191327
40	44	5.5	15	CAP191407
50	54	6.0	16	CAP191507
63	67	6.5	17	CAP191637

All dimensions in mm.





Cable Glands & Thread Conversion Products for Non-hazardous Areas

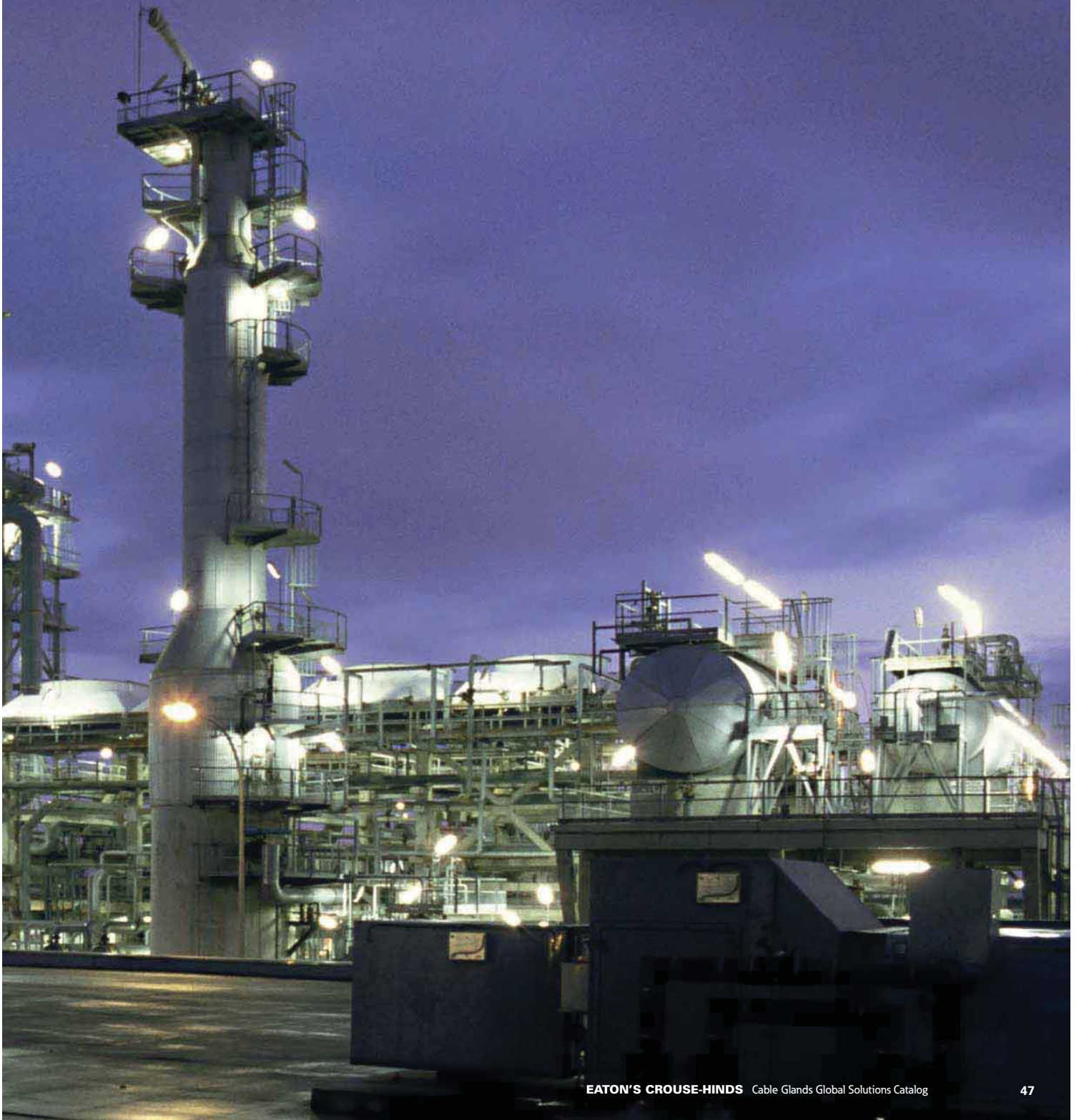

Capri IGA2 - for Non-armoured Cable

Technical Specification

Function

The IGA2 cable gland provides mechanical retention and a weatherproof seal on the outer sheath of the cable.

Suitable for the following cable types

- Non-armoured cable

Application

Suitable for indoor and outdoor applications.

Product Specification

Material:

Brass; nickel-plated brass

Operating Temperature:

- 60°C to +150°C

Standard

B.S. 6121 Part 1: 1989

Ingress Protection

- IP66



The gland kit is comprised of:

- Gland
- Shroud
- Earth Tag
- Locknut

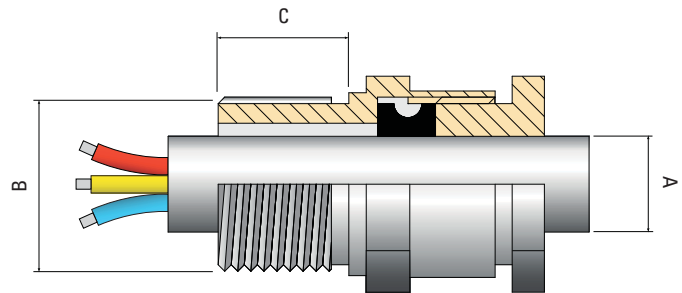

GLAND SIZE	ISO	CATALOG NUMBER ISO NATURAL BRASS (IN GLAND KIT)	CATALOG NUMBER ISO NICKEL-PLATED BRASS (IN GLAND KIT)	SELECTION TABLE					CATALOG NUMBER NPT NATURAL BRASS (IN GLAND KIT)	CATALOG NUMBER NPT NICKEL-PLATED BRASS (IN GLAND KIT)	
				ENTRY THREAD		DIA. MIN - MAX A	ACROSS FLATS	ACROSS CORNERS			NPT
				DIA. B	MIN LENGTH C						
16L	M16	IGA2M162BRNK2	IGA2M162NPNK2	16	12	3.50 - 9.00	21.00	24.00	3/8" NPT	IGA2N0372BRNK2	IGA2N0372NPNK2
20S	M20	IGA2M201BRNK2	IGA2M201NPNK2	20	10	8.00 - 11.70	22.00	25.00	1/2" NPT	IGA2N0501BRNK2	IGA2N0501NPNK2
20L	M20	IGA2M202BRNK2	IGA2M202NPNK2	20	10	11.00 - 14.00	24.00	26.50	1/2" NPT	IGA2N0502BRNK2	IGA2N0502NPNK2
25S	M25	IGA2M251BRNK2	IGA2M251NPNK2	25	15	12.00 - 17.00	27.00	30.50	3/4" NPT	IGA2N0751BRNK2	IGA2N0751NPNK2
25L	M25	IGA2M252BRNK2	IGA2M252NPNK2	25	10	13.00 - 20.00	29.50	33.00	3/4" NPT	IGA2N0752BRNK2	IGA2N0752NPNK2
32S	M32	IGA2M321BRNK2	IGA2M321NPNK2	32	15	16.50 - 23.00	37.00	41.00	1" NPT	IGA2N1001BRNK2	IGA2N1001NPNK2
32L	M32	IGA2M322BRNK2	IGA2M322NPNK2	32	10	19.00 - 26.30	39.00	43.00	1" NPT	IGA2N1002BRNK2	IGA2N1002NPNK2
40S	M40	IGA2M401BRNK2	IGA2M401NPNK2	40	20	23.00 - 29.00	45.00	50.00	1 1/4" NPT	IGA2N1251BRNK2	IGA2N1251NPNK2
40	M40	IGA2M402BRNK2	IGA2M402NPNK2	40	15	25.00 - 33.00	45.00	51.00	1 1/4" NPT	IGA2N1252BRNK2	IGA2N1252NPNK2
50S	M50	IGA2M501BRNK2	IGA2M501NPNK2	50	15	31.50 - 38.20	55.50	62.00	1 1/2" NPT	IGA2N1501BRNK2	IGA2N1501NPNK2
50L	M50	IGA2M502BRNK2	IGA2M502NPNK2	50	15	36.50 - 44.00	61.50	68.00	1 1/2" NPT	IGA2N1502BRNK2	IGA2N1502NPNK2
63S	M63	IGA2M631BRNK2	IGA2M631NPNK2	63	15	42.50 - 50.00	65.50	73.00	2" NPT	IGA2N2001BRNK2	IGA2N2001NPNK2
63L	M63	IGA2M632BRNK2	IGA2M632NPNK2	63	15	48.00 - 56.00	71.50	79.00	2" NPT	IGA2N2002BRNK2	IGA2N2002NPNK2
75S	M75	IGA2M751BRNK2	IGA2M751NPNK2	75	15	54.50 - 62.00	77.00	85.00	2 1/2" NPT	IGA2N2501BRNK2	IGA2N2501NPNK2
75L	M75	IGA2M752BRNK2	IGA2M752NPNK2	75	15	60.50 - 68.00	85.50	95.00	2 1/2" NPT	IGA2N2502BRNK2	IGA2N2502NPNK2
90L	M90	IGA2M902NPNK2	IGA2M902NPNK2	90	15	66.00 - 80.00	100.00	112.00	3" NPT	IGA2N3002BRNK2	IGA2N3002NPNK2

To order gland only, remove suffix "K2" from end of catalog number. Other sizes available on request.

Capri IGBW - for Armoured Cable

Technical Specification

Function

The IGBW cable gland provides mechanical retention and earth continuity through armour wire termination.

Suitable for the following cable types

- Single wire armoured cable (SWA)

Application

Suitable for indoor applications.

Product Specification

Material:

Brass; nickel-plated brass

Operating Temperature:

- 60°C to +150°C

Standard

B.S. 6121 Part 1: 1989

Ingress Protection

- IP66



The gland kit is comprised of:

- Gland
- Shroud
- Earth Tag
- Locknut

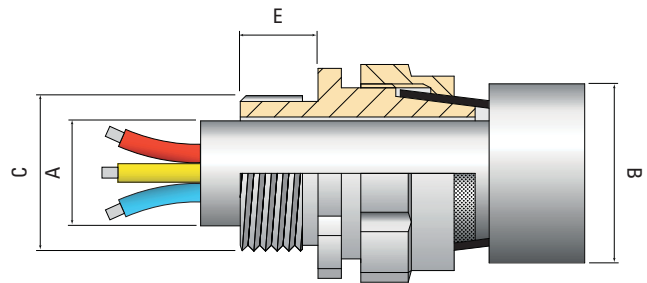

GLAND SIZE	ISO	CATALOG NUMBER ISO NATURAL BRASS (IN GLAND KIT)	CATALOG NUMBER ISO NICKEL-PLATED BRASS (IN GLAND KIT)	SELECTION TABLE								CATALOG NUMBER NPT NATURAL BRASS (IN GLAND KIT)	CATALOG NUMBER NPT NICKEL-PLATED BRASS (IN GLAND KIT)
				ENTRY THREAD		CABLE DIMENSION ACCOMMODATION			ACROSS FLATS	ACROSS CORNERS	NPT		
				DIA. C	MIN LENGTH E	DIA. MAX A	DIA. MAX B	ARMOUR THICKNESS					
20S	M20	IGBWM201BRNK2	IGBWM201NPNK2	20	10	11.50	16.00	0.90 / 1.25	21.00	23.40	1/2" NPT	IGBWN0501BRNK2	IGBWN0501NPNK2
20L	M20	IGBWM202BRNK2	IGBWM202NPNK2	20	10	14.50	20.00	0.90 / 1.25	24.00	27.00	1/2" NPT	IGBWN0502BRNK2	IGBWN0502NPNK2
25L	M25	IGBWM252BRNK2	IGBWM252NPNK2	25	10	20.50	26.00	1.25 / 1.60	31.50	35.00	3/4" NPT	IGBWN0752BRNK2	IGBWN0752NPNK2
32L	M32	IGBWM322BRNK2	IGBWM322NPNK2	32	10	26.30	33.00	1.60 / 2.00	40.00	45.00	1" NPT	IGBWN1002BRNK2	IGBWN1002NPNK2
40L	M40	IGBWM402BRNK2	IGBWM402NPNK2	40	15	33.00	40.50	1.60 / 2.00	49.00	55.00	1 1/4" NPT	IGBWN1252BRNK2	IGBWN1252NPNK2
50L	M50	IGBWM502BRNK2	IGBWM502NPNK2	50	15	43.50	52.50	2.00 / 2.50	60.50	68.50	1 1/2" NPT	IGBWN1502BRNK2	IGBWN1502NPNK2
63L	M63	IGBWM632BRNK2	IGBWM632NPNK2	63	15	56.00	66.00	2.50	76.00	86.00	2" NPT	IGBWN2002BRNK2	IGBWN2002NPNK2
75L	M75	IGBWM752BRNK2	IGBWM752NPNK2	75	15	68.00	78.00	2.50	88.00	98.00	2 1/2" NPT	IGBWN2502BRNK2	IGBWN2502NPNK2
90L	M90	IGBWM902BRNK2	IGBWM902NPNK2	90	15	79.00	90.00	2.50 / 3.15	104.30	117.00	3" NPT	IGBWN3002BRNK2	IGBWN3002NPNK2

To order gland only, remove suffix "K2" from end of catalog number.
Other sizes available on request.

Capri IGCW - for Armoured Cable

Technical Specification

Function

The IGCW cable gland provides mechanical retention, a weatherproof seal on the outer sheath of the cable and earth continuity through armour wire termination.

Suitable for the following cable types

Single wire armoured cable (SWA)

Application

Suitable for indoor and outdoor applications.

Product Specification

Material:

Brass; nickel-plated brass

Operating Temperature:

- 60°C to +150°C

Standard

B.S. 6121 Part 1: 1989

Ingress Protection

- IP66



The gland kit is comprised of:

- Gland
- Shroud
- Earth Tag
- Locknut

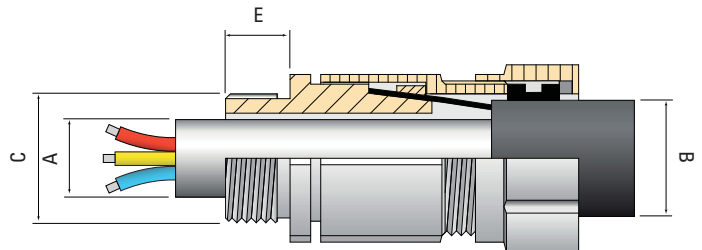

GLAND SIZE	ISO	CATALOG NUMBER ISO NATURAL BRASS (IN GLAND KIT)	CATALOG NUMBER ISO NICKEL-PLATED BRASS (IN GLAND KIT)	SELECTION TABLE								CATALOG NUMBER NPT NATURAL BRASS (IN GLAND KIT)	CATALOG NUMBER NPT NICKEL-PLATED BRASS (IN GLAND KIT)
				ENTRY THREAD		CABLE DIMENSION ACCOMMODATION			ACROSS FLATS	ACROSS CORNERS	NPT		
				DIA. C	MIN LENGTH E	MIN - MAX A	MIN - MAX B	ARMOUR THICKNESS					
20S	M20	IGCWM201BRNK2	IGCWM201NPNK2	20	10	8.00 - 11.50	12.00 - 16.00	0.90 / 1.25	22.00	25.00	1/2" NPT	IGCWN0501BRNK2	IGCWN0501NPNK2
20L	M20	IGCWM202BRNK2	IGCWM202NPNK2	20	10	11.00 - 14.50	15.50 - 20.50	0.90 / 1.25	25.50	28.50	1/2" NPT	IGCWN0502BRNK2	IGCWN0502NPNK2
25S	M25	IGCWM251BRNK2	IGCWM251NPNK2	25	10	12.00 - 19.00	17.50 - 24.00	1.25 / 1.60	30.00	33.60	3/4" NPT	IGCWN0751BRNK2	IGCWN0751NPNK2
25L	M25	IGCWM252BRNK2	IGCWM252NPNK2	25	10	13.00 - 20.50	24.00 - 27.00	1.25 / 1.60	33.50	37.50	3/4" NPT	IGCWN0752BRNK2	IGCWN0752NPNK2
32S	M32	IGCWM321BRNK2	IGCWM321NPNK2	32	10	17.00 - 24.00	25.00 - 30.50	1.60 / 2.00	38.00	43.00	1" NPT	IGCWN1001BRNK2	IGCWN1001NPNK2
32L	M32	IGCWM322BRNK2	IGCWM322NPNK2	32	10	19.00 - 26.30	26.00 - 33.00	1.60 / 2.00	40.50	45.50	1" NPT	IGCWN1002BRNK2	IGCWN1002NPNK2
40S	M40	IGCWM401BRNK2	IGCWM401NPNK2	40	11	23.00 - 30.00	31.00 - 37.00	1.60 / 2.00	44.50	50.00	1 1/4" NPT	IGCWN1251BRNK2	IGCWN1251NPNK2
40L	M40	IGCWM402BRNK2	IGCWM402NPNK2	40	15	25.00 - 33.50	33.00 - 40.50	1.60 / 2.00	49.50	56.00	1 1/4" NPT	IGCWN1252BRNK2	IGCWN1252NPNK2
50S	M50	IGCWM501BRNK2	IGCWM501NPNK2	50	13	31.50 - 40.00	39.40 - 47.50	2.00 / 2.50	55.00	62.00	1 1/2" NPT	IGCWN1501BRNK2	IGCWN1501NPNK2
50L	M50	IGCWM502BRNK2	IGCWM502NPNK2	50	15	36.50 - 43.50	45.70 - 52.50	2.00 / 2.50	61.00	68.00	1 1/2" NPT	IGCWN1502BRNK2	IGCWN1502NPNK2
63S	M63	IGCWM631BRNK2	IGCWM631NPNK2	63	14	42.50 - 51.00	52.10 - 60.00	2.50	69.00	76.00	2" NPT	IGCWN2001BRNK2	IGCWN2001NPNK2
63L	M63	IGCWM632BRNK2	IGCWM632NPNK2	63	15	49.00 - 56.00	58.40 - 66.00	2.50	77.50	86.00	2" NPT	IGCWN2002BRNK2	IGCWN2002NPNK2
75S	M75	IGCWM751BRNK2	IGCWM751NPNK2	75	15	54.50 - 62.00	64.80 - 72.00	2.50	83.00	94.00	2 1/2" NPT	IGCWN2501BRNK2	IGCWN2501NPNK2
75L	M75	IGCWM752BRNK2	IGCWM752NPNK2	75	15	60.50 - 68.00	71.00 - 78.00	2.50	92.00	102.00	2 1/2" NPT	IGCWN2502BRNK2	IGCWN2502NPNK2
90L	M90	IGCWM902BRNK2	IGCWM902NPNK2	90	20	66.00 - 79.00	77.00 - 90.00	2.50 / 3.15	105.00	118.00	3" NPT	IGCWN3002BRNK2	IGCWN3002NPNK2

To order gland only, remove suffix "K2" from end of catalog number.
Other sizes available on request.



Capri IGCX - for Armoured Cable

Technical Specification

Function

The IGCX cable gland provides mechanical retention, a weatherproof seal on the outer sheath of the cable and earth continuity through armour wire termination.

Suitable for the following cable types

-  Wire braid armoured cable (SWB)
-  Steel tape armoured cable (STA)

Application

Suitable for indoor and outdoor applications.

Product Specification

Material:

Brass; nickel-plated brass

Operating Temperature:

- -60°C to +150°C

Standard

B.S. 6121 Part 1: 1989

Ingress Protection

- IP66



The gland kit is comprised of:

- Gland
- Shroud
- Earth Tag
- Locknut

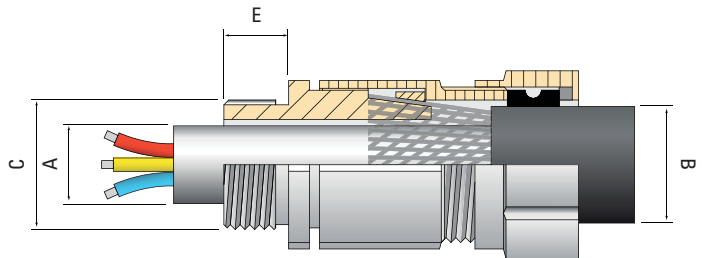

GLAND SIZE	ISO	CATALOG NUMBER ISO NATURAL BRASS (IN GLAND KIT)	CATALOG NUMBER ISO NICKEL-PLATED BRASS (IN GLAND KIT)	SELECTION TABLE								CATALOG NUMBER NPT NATURAL BRASS (IN GLAND KIT)	CATALOG NUMBER NPT NICKEL-PLATED BRASS (IN GLAND KIT)
				ENTRY THREAD		CABLE DIMENSION ACCOMMODATION			ACROSS FLATS	ACROSS CORNERS	NPT		
				DIA. C	MIN LENGTH E	MIN - MAX A	MIN - MAX B	ARMOUR THICKNESS					
20S	M20	IGCXM201BRNK2	IGCXM201NPNK2	20	10	8.00 - 11.50	12.00 - 16.00	0.90 / 1.25	22.00	25.00	1/2" NPT	IGCXN0501BRNK2	IGCXN0501NPNK2
20L	M20	IGCXM202BRNK2	IGCXM202NPNK2	20	10	11.00 - 14.50	15.50 - 20.50	0.90 / 1.25	25.50	28.50	1/2" NPT	IGCXN0502BRNK2	IGCXN0502NPNK2
25S	M25	IGCXM251BRNK2	IGCXM251NPNK2	25	10	12.00 - 19.00	17.50 - 24.00	1.25 / 1.60	30.00	33.60	3/4" NPT	IGCXN0751BRNK2	IGCXN0751NPNK2
25L	M25	IGCXM252BRNK2	IGCXM252NPNK2	25	10	13.00 - 20.50	24.00 - 27.00	1.25 / 1.60	33.50	37.50	3/4" NPT	IGCXN0752BRNK2	IGCXN0752NPNK2
32S	M32	IGCXM321BRNK2	IGCXM321NPNK2	32	10	17.00 - 24.00	25.00 - 30.50	1.60 / 2.00	38.00	43.00	1" NPT	IGCXN1001BRNK2	IGCXN1001NPNK2
32L	M32	IGCXM322BRNK2	IGCXM322NPNK2	32	10	19.00 - 26.30	26.00 - 33.00	1.60 / 2.00	40.50	45.50	1" NPT	IGCXN1002BRNK2	IGCXN1002NPNK2
40S	M40	IGCXM401BRNK2	IGCXM401NPNK2	40	11	23.00 - 30.00	31.00 - 37.00	1.60 / 2.00	44.50	50.00	1 1/4" NPT	IGCXN1251BRNK2	IGCXN1251NPNK2
40L	M40	IGCXM402BRNK2	IGCXM402NPNK2	40	15	25.00 - 33.50	33.00 - 40.50	1.60 / 2.00	49.50	56.00	1 1/4" NPT	IGCXN1252BRNK2	IGCXN1252NPNK2
50S	M50	IGCXM501BRNK2	IGCXM501NPNK2	50	13	31.50 - 40.00	39.40 - 47.50	2.00 / 2.5	55.00	62.00	1 1/2" NPT	IGCXN1501BRNK2	IGCXN1501NPNK2
50L	M50	IGCXM502BRNK2	IGCXM502NPNK2	50	15	36.50 - 43.50	45.70 - 52.50	2.00 / 2.50	61.00	68.00	1 1/2" NPT	IGCXN1502BRNK2	IGCXN1502NPNK2
63S	M63	IGCXM631BRNK2	IGCXM631NPNK2	63	14	42.50 - 51.00	52.10 - 60.00	2.50	69.00	76.00	2" NPT	IGCXN2001BRNK2	IGCXN2001NPNK2
63L	M63	IGCXM632BRNK2	IGCXM632NPNK2	63	15	49.00 - 56.00	58.40 - 66.00	2.50	77.50	86.00	2" NPT	IGCXN2002BRNK2	IGCXN2002NPNK2
75S	M75	IGCXM751BRNK2	IGCXM751NPNK2	75	15	54.50 - 62.00	64.80 - 72.00	2.50	83.00	94.00	2 1/2" NPT	IGCXN2501BRNK2	IGCXN2501NPNK2
75L	M75	IGCXM752BRNK2	IGCXM752NPNK2	75	15	60.50 - 68.00	71.00 - 78.00	2.50	92.00	102.00	2 1/2" NPT	IGCXN2502BRNK2	IGCXN2502NPNK2
90L	M90	IGCXM902BRNK2	IGCXM902NPNK2	90	20	66.00 - 79.00	77.00 - 90.00	2.50 / 3.15	105.00	118.00	3" NPT	IGCXN3002BRNK2	IGCXN3002NPNK2

To order gland only, remove suffix "K2" from end of catalog number.
Other sizes available on request.

Capri IGE1W - for Armoured Cable

Technical Specification

Function

The IGE1W cable gland provides mechanical retention, a weatherproof seal on the inner and outer sheath of the cable and earth continuity through armour wire termination.

Suitable for the following cable types

Single wire armoured cable (SWA)

Application

Suitable for indoor and outdoor applications.

Product Specification

Material:

Brass; nickel-plated brass

Operating Temperature:

- 60°C to +150°C

Standard

B.S. 6121 Part 1: 1989

Ingress Protection

- IP66



The gland kit is comprised of:

- Gland
- Shroud
- Earth Tag
- Locknut

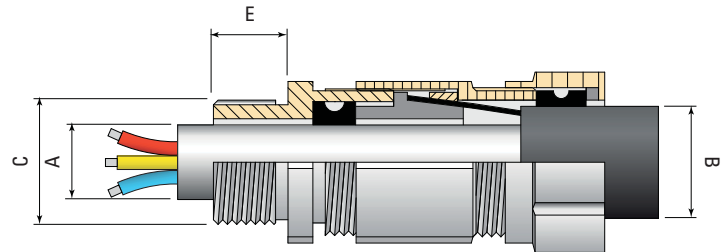

GLAND SIZE	ISO	CATALOG NUMBER ISO NATURAL BRASS (IN GLAND KIT)	CATALOG NUMBER ISO NICKEL-PLATED BRASS (IN GLAND KIT)	SELECTION TABLE								CATALOG NUMBER NPT NATURAL BRASS (IN GLAND KIT)	CATALOG NUMBER NPT NICKEL-PLATED BRASS (IN GLAND KIT)
				ENTRY THREAD		CABLE DIMENSION ACCOMMODATION			ACROSS FLATS	ACROSS CORNERS	NPT		
				DIA. C	MIN LENGTH E	MIN - MAX A	MIN - MAX B	ARMOUR THICKNESS					
20S	M20	IGE1WM201BRNK2	IGE1WM201NPNK2	20	10	8.00 - 11.80	12.00 - 16.00	0.90 / 1.25	22.00	25.00	1/2" NPT	IGE1WN0501BRNK2	IGE1WN0501NPNK2
20L	M20	IGE1WM202BRNK2	IGE1WM202NPNK2	20	10	11.00 - 14.00	15.50 - 20.50	0.90 / 1.25	26.00	29.00	1/2" NPT	IGE1WN0502BRNK2	IGE1WN0502NPNK2
25S	M25	IGE1WM251BRNK2	IGE1WM251NPNK2	25	10	12.00 - 17.00	17.50 - 24.00	1.25 / 1.60	31.50	35.00	3/4" NPT	IGE1WN0751BRNK2	IGE1WN0751NPNK2
25L	M25	IGE1WM252BRNK2	IGE1WM252NPNK2	25	10	13.00 - 20.30	24.00 - 27.00	1.25 / 1.60	34.00	38.00	3/4" NPT	IGE1WN0752BRNK2	IGE1WN0752NPNK2
32S	M32	IGE1WM321BRNK2	IGE1WM321NPNK2	32	10	17.00 - 24.00	25.00 - 31.00	1.60 / 2.00	43.00	47.50	1" NPT	IGE1WN1001BRNK2	IGE1WN1001NPNK2
32L	M32	IGE1WM322BRNK2	IGE1WM322NPNK2	32	10	19.00 - 26.30	26.00 - 33.00	1.60 / 2.00	41.00	46.00	1" NPT	IGE1WN1002BRNK2	IGE1WN1002NPNK2
40S	M40	IGE1WM401BRNK2	IGE1WM401NPNK2	40	15	23.00 - 30.00	31.00 - 38.50	1.60 / 2.00	51.50	57.00	1 1/4" NPT	IGE1WN1251BRNK2	IGE1WN1251NPNK2
40L	M40	IGE1WM402BRNK2	IGE1WM402NPNK2	40	15	25.00 - 33.00	33.00 - 40.50	1.60 / 2.00	49.50	56.00	1 1/4" NPT	IGE1WN1252BRNK2	IGE1WN1252NPNK2
50S	M50	IGE1WM501BRNK2	IGE1WM501NPNK2	50	15	31.50 - 38.20	39.40 - 46.80	2.00 / 2.50	58.50	65.00	1 1/2" NPT	IGE1WN1501BRNK2	IGE1WN1501NPNK2
50L	M50	IGE1WM502BRNK2	IGE1WM502NPNK2	50	15	36.50 - 44.00	45.70 - 52.50	2.00 / 2.50	61.00	68.00	1 1/2" NPT	IGE1WN1502BRNK2	IGE1WN1502NPNK2
63S	M63	IGE1WM631BRNK2	IGE1WM631NPNK2	63	15	42.50 - 50.00	52.10 - 59.00	2.50	72.00	80.00	2" NPT	IGE1WN2001BRNK2	IGE1WN2001NPNK2
63L	M63	IGE1WM632BRNK2	IGE1WM632NPNK2	63	15	49.00 - 56.00	58.40 - 66.00	2.50	77.50	86.00	2" NPT	IGE1WN2002BRNK2	IGE1WN2002NPNK2
75S	M75	IGE1WM751BRNK2	IGE1WM751NPNK2	75	17	54.50 - 62.00	64.80 - 72.00	2.50	86.50	97.00	2 1/2" NPT	IGE1WN2501BRNK2	IGE1WN2501NPNK2
75L	M75	IGE1WM752BRNK2	IGE1WM752NPNK2	75	15	60.50 - 68.00	71.00 - 78.00	2.50	92.00	102.00	2 1/2" NPT	IGE1WN2502BRNK2	IGE1WN2502NPNK2
90L	M90	IGE1WM902BRNK2	IGE1WM902NPNK2	90	20	66.00 - 79.00	77.00 - 90.00	2.50 / 3.15	106.00	118.00	3" NPT	IGE1WN3002BRNK2	IGE1WN3002NPNK2

To order gland only, remove suffix "K2" from end of catalog number. Other sizes available on request.



Capri IGE1X - for Armoured Cable

Technical Specification

Function

The IGE1X cable gland provides mechanical retention, a weatherproof seal on the inner and outer sheath of the cable and earth continuity through armour wire termination.

Suitable for the following cable types

-  Wire braid armoured cable (SWB)
-  Steel tape armoured cable (STA)

Application

Suitable for indoor and outdoor applications.

Product Specification

Material:

Brass; nickel-plated brass

Operating Temperature:

- -60°C to +150°C

Standard

B.S. 6121 Part 1: 1989

Ingress Protection

- IP66



The gland kit is comprised of:

- Gland
- Shroud
- Earth Tag
- Locknut

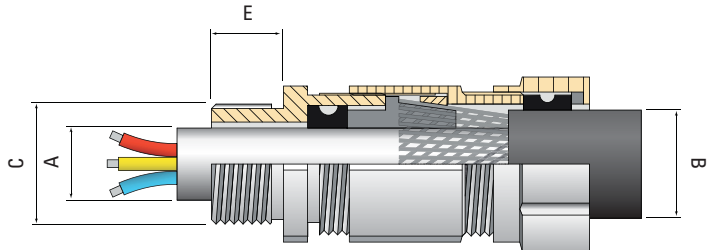

GLAND SIZE	ISO	CATALOG NUMBER ISO NATURAL BRASS (IN GLAND KIT)	CATALOG NUMBER ISO NICKEL-PLATED BRASS (IN GLAND KIT)	SELECTION TABLE							CATALOG NUMBER NPT NATURAL BRASS (IN GLAND KIT)	CATALOG NUMBER NPT NICKEL-PLATED BRASS (IN GLAND KIT)	
				ENTRY THREAD		CABLE DIMENSION ACCOMMODATION			ACROSS FLATS	ACROSS CORNERS			NPT
				DIA. C	MIN LENGTH E	MIN - MAX A	MIN - MAX B	ARMOUR THICKNESS					
20S	M20	IGE1XM201BRNK2	IGE1XM201NPNK2	20	10	8.00 - 11.80	12.00 - 16.00	0.90 / 1.25	22.00	25.00	1/2" NPT	IGE1XN0501BRNK2	IGE1XN0501NPNK2
20L	M20	IGE1XM202BRNK2	IGE1XM202NPNK2	20	10	11.00 - 14.00	15.50 - 20.50	0.90 / 1.25	26.00	29.00	1/2" NPT	IGE1XN0502BRNK2	IGE1XN0502NPNK2
25S	M25	IGE1XM251BRNK2	IGE1XM251NPNK2	25	10	12.00 - 17.00	17.50 - 24.00	1.25 / 1.60	31.50	35.00	3/4" NPT	IGE1XN0751BRNK2	IGE1XN0751NPNK2
25L	M25	IGE1XM252BRNK2	IGE1XM252NPNK2	25	10	13.00 - 20.30	24.00 - 27.00	1.25 / 1.60	34.00	38.00	3/4" NPT	IGE1XN0752BRNK2	IGE1XN0752NPNK2
32S	M32	IGE1XM321BRNK2	IGE1XM321NPNK2	32	10	17.00 - 24.00	25.00 - 31.00	1.60 / 2.00	43.00	47.50	1" NPT	IGE1XN1001BRNK2	IGE1XN1001NPNK2
32L	M32	IGE1XM322BRNK2	IGE1XM322NPNK2	32	10	19.00 - 26.30	26.00 - 33.00	1.60 / 2.00	41.00	46.00	1" NPT	IGE1XN1002BRNK2	IGE1XN1002NPNK2
40S	M40	IGE1XM401BRNK2	IGE1XM401NPNK2	40	15	23.00 - 30.00	31.00 - 38.50	1.60 / 2.00	51.50	57.00	1 1/4" NPT	IGE1XN1251BRNK2	IGE1XN1251NPNK2
40L	M40	IGE1XM402BRNK2	IGE1XM402NPNK2	40	15	25.00 - 33.00	33.00 - 40.50	1.60 / 2.00	49.50	56.00	1 1/4" NPT	IGE1XN1252BRNK2	IGE1XN1252NPNK2
50S	M50	IGE1XM501BRNK2	IGE1XM501NPNK2	50	15	31.50 - 38.20	39.40 - 46.80	2.00 / 2.50	58.50	65.00	1 1/2" NPT	IGE1XN1501BRNK2	IGE1XN1501NPNK2
50L	M50	IGE1XM502BRNK2	IGE1XM502NPNK2	50	15	36.50 - 44.00	45.70 - 52.50	2.00 / 2.50	61.00	68.00	1 1/2" NPT	IGE1XN1502BRNK2	IGE1XN1502NPNK2
63S	M63	IGE1XM631BRNK2	IGE1XM631NPNK2	63	15	42.50 - 50.00	52.10 - 59.00	2.50	72.00	80.00	2" NPT	IGE1XN2001BRNK2	IGE1XN2001NPNK2
63L	M63	IGE1XM632BRNK2	IGE1XM632NPNK2	63	15	49.00 - 56.00	58.40 - 66.00	2.50	77.50	86.00	2" NPT	IGE1XN2002BRNK2	IGE1XN2002NPNK2
75S	M75	IGE1XM751BRNK2	IGE1XM751NPNK2	75	17	54.50 - 62.00	64.80 - 72.00	2.50	86.50	97.00	2 1/2" NPT	IGE1XN2501BRNK2	IGE1XN2501NPNK2
75L	M75	IGE1XM752BRNK2	IGE1XM752NPNK2	75	15	60.50 - 68.00	71.00 - 78.00	2.50	92.00	102.00	2 1/2" NPT	IGE1XN2502BRNK2	IGE1XN2502NPNK2
90L	M90	IGE1XM902BRNK2	IGE1XM902NPNK2	90	20	66.00 - 79.00	77.00 - 90.00	2.50 / 3.15	106.00	118.00	3" NPT	IGE1XN3002BRNK2	IGE1XN3002NPNK2

To order gland only, remove suffix "K2" from end of catalog number.
Other sizes available on request.



Capri IGE2W - for Armoured Cable

Technical Specification

Function

The IGE2W cable gland provides mechanical retention, a weatherproof seal on the inner and outer sheath of the cable and earth continuity through armour wire termination.

Suitable for the following cable types

-  Single wire armoured cable (SWA)
-  Lead sheathed cable

Application

Suitable for indoor and outdoor applications.

Product Specification

Material:

Brass; nickel-plated brass

Operating Temperature:

- -60°C to +150°C

Ingress Protection

- IP66



The gland kit is comprised of:

- Gland
- Shroud
- Earth Tag
- Locknut

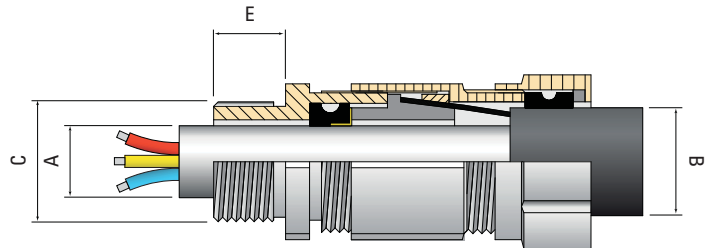

GLAND SIZE	ISO	CATALOG NUMBER ISO NATURAL BRASS (IN GLAND KIT)	CATALOG NUMBER ISO NICKEL-PLATED BRASS (IN GLAND KIT)	SELECTION TABLE								CATALOG NUMBER NPT NATURAL BRASS (IN GLAND KIT)	CATALOG NUMBER NPT NICKEL-PLATED BRASS (IN GLAND KIT)
				ENTRY THREAD		CABLE DIMENSION ACCOMMODATION			ACROSS FLATS	ACROSS CORNERS	NPT		
				DIA. C	MIN LENGTH E	MIN - MAX A	MIN - MAX B	ARMOUR THICKNESS					
20S	M20	IGE2WM201BRNK2	IGE2WM201NPNK2	20	10	8.00 - 11.80	12.00 - 16.00	0.90 / 1.25	22.00	25.00	1/2" NPT	IGE2WN0501BRNK2	IGE2WN0501NPNK2
20L	M20	IGE2WM202BRNK2	IGE2WM202NPNK2	20	10	11.00 - 14.00	15.50 - 20.50	0.90 / 1.25	26.00	29.00	1/2" NPT	IGE2WN0502BRNK2	IGE2WN0502NPNK2
25S	M25	IGE2WM251BRNK2	IGE2WM251NPNK2	25	10	12.00 - 17.00	17.50 - 24.00	1.25 / 1.60	31.50	35.00	3/4" NPT	IGE2WN0751BRNK2	IGE2WN0751NPNK2
25L	M25	IGE2WM252BRNK2	IGE2WM252NPNK2	25	10	13.00 - 20.30	24.00 - 27.00	1.25 / 1.60	34.00	38.00	3/4" NPT	IGE2WN0752BRNK2	IGE2WN0752NPNK2
32S	M32	IGE2WM321BRNK2	IGE2WM321NPNK2	32	10	17.00 - 24.00	25.00 - 31.00	1.60 / 2.00	43.00	47.50	1" NPT	IGE2WN1001BRNK2	IGE2WN1001NPNK2
32L	M32	IGE2WM322BRNK2	IGE2WM322NPNK2	32	10	19.00 - 26.30	26.00 - 33.00	1.60 / 2.00	41.00	46.00	1" NPT	IGE2WN1002BRNK2	IGE2WN1002NPNK2
40S	M40	IGE2WM401BRNK2	IGE2WM401NPNK2	40	15	23.00 - 30.00	31.00 - 38.50	1.60 / 2.00	51.50	57.00	1 1/4" NPT	IGE2WN1251BRNK2	IGE2WN1251NPNK2
40L	M40	IGE2WM402BRNK2	IGE2WM402NPNK2	40	15	25.00 - 33.00	33.00 - 40.50	1.60 / 2.00	49.50	56.00	1 1/4" NPT	IGE2WN1252BRNK2	IGE2WN1252NPNK2
50S	M50	IGE2WM501BRNK2	IGE2WM501NPNK2	50	15	31.50 - 38.20	39.40 - 46.80	2.00 / 2.50	58.50	65.00	1 1/2" NPT	IGE2WN1501BRNK2	IGE2WN1501NPNK2
50L	M50	IGE2WM502BRNK2	IGE2WM502NPNK2	50	15	36.50 - 44.00	45.70 - 52.50	2.00 / 2.50	61.00	68.00	1 1/2" NPT	IGE2WN1502BRNK2	IGE2WN1502NPNK2
63S	M63	IGE2WM631BRNK2	IGE2WM631NPNK2	63	15	42.50 - 50.00	52.10 - 59.00	2.50	72.00	80.00	2" NPT	IGE2WN2001BRNK2	IGE2WN2001NPNK2
63L	M63	IGE2WM632BRNK2	IGE2WM632NPNK2	63	15	49.00 - 56.00	58.40 - 66.00	2.50	77.50	86.00	2" NPT	IGE2WN2002BRNK2	IGE2WN2002NPNK2
75S	M75	IGE2WM751BRNK2	IGE2WM751NPNK2	75	17	54.50 - 62.00	64.80 - 72.00	2.50	86.50	97.00	2 1/2" NPT	IGE2WN2501BRNK2	IGE2WN2501NPNK2
75L	M75	IGE2WM752BRNK2	IGE2WM752NPNK2	75	15	60.50 - 68.00	71.00 - 78.00	2.50	92.00	102.00	2 1/2" NPT	IGE2WN2502BRNK2	IGE2WN2502NPNK2
90L	M90	IGE2WM902BRNK2	IGE2WM902NPNK2	90	20	66.00 - 79.00	77.00 - 90.00	2.50 / 3.15	106.00	118.00	3" NPT	IGE2WN3002BRNK2	IGE2WN3002NPNK2

To order gland only, remove suffix "K2" from end of catalog number.
Other sizes available on request.



Capri IGE2X - for Armoured Cable

Technical Specification

Function

The IGE2X cable gland provides mechanical retention, a weatherproof seal on the inner and outer sheath of the cable and earth continuity through armour wire termination.

Suitable for the following cable types

-  Wire braid armoured cable (SWB)
-  Steel tape armoured cable (STA)
-  Lead sheathed cable

Application

Suitable for indoor and outdoor applications.

Product Specification

Material:

Brass; nickel-plated brass

Operating Temperature:

- -60°C to +150°C

Ingress Protection

- IP66



The gland kit is comprised of:

- Gland
- Shroud
- Earth Tag
- Locknut

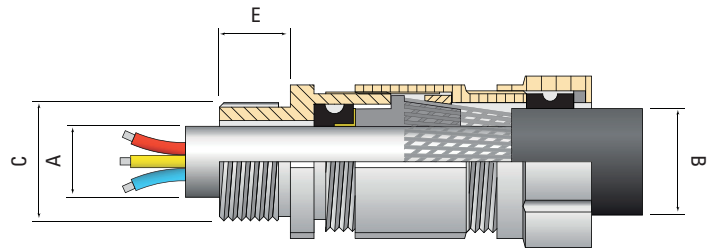

GLAND SIZE	ISO	CATALOG NUMBER ISO NATURAL BRASS (IN GLAND KIT)	CATALOG NUMBER ISO NICKEL-PLATED BRASS (IN GLAND KIT)	SELECTION TABLE							CATALOG NUMBER NPT NATURAL BRASS (IN GLAND KIT)	CATALOG NUMBER NPT NICKEL-PLATED BRASS (IN GLAND KIT)	
				ENTRY THREAD		CABLE DIMENSION ACCOMMODATION			ACROSS FLATS	ACROSS CORNERS			NPT
				DIA. C	MIN LENGTH E	MIN - MAX A	MIN - MAX B	ARMOUR THICKNESS					
20S	M20	IGE2XM201BRNK2	IGE2XM201NPNK2	20	10	8.00 - 11.80	12.00 - 16.00	0.90 / 1.25	22.00	25.00	1/2" NPT	IGE2XN0501BRNK2	IGE2XN0501NPNK2
20L	M20	IGE2XM202BRNK2	IGE2XM202NPNK2	20	10	11.00 - 14.00	15.50 - 20.50	0.90 / 1.25	26.00	29.00	1/2" NPT	IGE2XN0502BRNK2	IGE2XN0502NPNK2
25S	M25	IGE2XM251BRNK2	IGE2XM251NPNK2	25	10	12.00 - 17.00	17.50 - 24.00	1.25 / 1.60	31.50	35.00	3/4" NPT	IGE2XN0751BRNK2	IGE2XN0751NPNK2
25L	M25	IGE2XM252BRNK2	IGE2XM252NPNK2	25	10	13.00 - 20.30	24.00 - 27.00	1.25 / 1.60	34.00	38.00	3/4" NPT	IGE2XN0752BRNK2	IGE2XN0752NPNK2
32S	M32	IGE2XM321BRNK2	IGE2XM321NPNK2	32	10	17.00 - 24.00	25.00 - 31.00	1.60 / 2.00	43.00	47.50	1" NPT	IGE2XN1001BRNK2	IGE2XN1001NPNK2
32L	M32	IGE2XM322BRNK2	IGE2XM322NPNK2	32	10	19.00 - 26.30	26.00 - 33.00	1.60 / 2.00	41.00	46.00	1" NPT	IGE2XN1002BRNK2	IGE2XN1002NPNK2
40S	M40	IGE2XM401BRNK2	IGE2XM401NPNK2	40	15	23.00 - 30.00	31.00 - 38.50	1.60 / 2.00	51.50	57.00	1 1/4" NPT	IGE2XN1251BRNK2	IGE2XN1251NPNK2
40L	M40	IGE2XM402BRNK2	IGE2XM402NPNK2	40	15	25.00 - 33.00	33.00 - 40.50	1.60 / 2.00	49.50	56.00	1 1/4" NPT	IGE2XN1252BRNK2	IGE2XN1252NPNK2
50S	M50	IGE2XM501BRNK2	IGE2XM501NPNK2	50	15	31.50 - 38.20	39.40 - 46.80	2.00 / 2.50	58.50	65.00	1 1/2" NPT	IGE2XN1501BRNK2	IGE2XN1501NPNK2
50L	M50	IGE2XM502BRNK2	IGE2XM502NPNK2	50	15	36.50 - 44.00	45.70 - 52.50	2.00 / 2.50	61.00	68.00	1 1/2" NPT	IGE2XN1502BRNK2	IGE2XN1502NPNK2
63S	M63	IGE2XM631BRNK2	IGE2XM631NPNK2	63	15	42.50 - 50.00	52.10 - 59.00	2.50	72.00	80.00	2" NPT	IGE2XN2001BRNK2	IGE2XN2001NPNK2
63L	M63	IGE2XM632BRNK2	IGE2XM632NPNK2	63	15	49.00 - 56.00	58.40 - 66.00	2.50	77.50	86.00	2" NPT	IGE2XN2002BRNK2	IGE2XN2002NPNK2
75S	M75	IGE2XM751BRNK2	IGE2XM751NPNK2	75	17	54.50 - 62.00	64.80 - 72.00	2.50	86.50	97.00	2 1/2" NPT	IGE2XN2501BRNK2	IGE2XN2501NPNK2
75L	M75	IGE2XM752BRNK2	IGE2XM752NPNK2	75	15	60.50 - 68.00	71.00 - 78.00	2.50	92.00	102.00	2 1/2" NPT	IGE2XN2502BRNK2	IGE2XN2502NPNK2
90L	M90	IGE2XM902BRNK2	IGE2XM902NPNK2	90	20	66.00 - 79.00	77.00 - 90.00	2.50 / 3.15	106.00	118.00	3" NPT	IGE2XN3002BRNK2	IGE2XN3002NPNK2

To order gland only, remove suffix "K2" from end of catalog number. Other sizes available on request.

Technical Specification

Suitable for the following cable types

- ➡ Non-armoured cable

Certifications and Compliances

EN 50262

Product Specification

Material:

Nickel-plated brass for superior corrosion resistance.
316 stainless steel option available.

It is recommended that a suitable lubricant is used on all threads of stainless steel and aluminum versions.

Operating Temperature:

- Neoprene seal: -20°C to +80°C

Ingress Protection (IP)

- IP66/IP68 tested 30m/7days on surface Ra 1.6µm max.

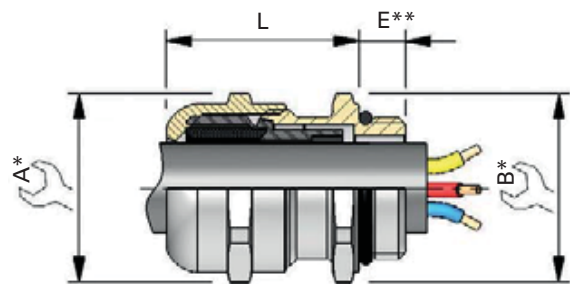

* For 'across corners' dimensions, multiply 'across flats' dimensions by 1.1

** For 'E' see Thread Dimension page 87

SELECTION TABLE			DIMENSIONS				GLAND SIZE	CATALOG NUMBER ISO (NICKEL-PLATED BRASS)	CATALOG NUMBER ISO (316 STAINLESS STEEL LONG FIXING THREAD)	CATALOG NUMBER Pg (NICKEL-PLATED BRASS)	CATALOG NUMBER Pg (316 STAINLESS STEEL LONG FIXING THREAD)
THREAD SIZE	THREAD SIZE	BRAID THICKNESS	CABLE DIAMETER MIN - MAX	A	B	L (LENGTH)					
ISO	Pg										
12	Pg 7	0.7	3.0 - 6.5	15	15	18	4	CAP187124	CAP187129	CAP186074	CAP186079
16	-	0.7	3.0 - 6.5	15	18	18	4	CAP187544	CAP187549	-	-
16	Pg 9	0.7	4.5 - 10.0	20	20	24	5	CAP187164	CAP187169	CAP186094	CAP186099
20	-	0.7	4.5 - 10.0	20	22	24	5	CAP187554	CAP187559	-	-
20	Pg 11	0.8	6.0 - 13.0	24	24	27	6	CAP187204	CAP187209	CAP186114	CAP186119
-	Pg 13	0.8	6.0 - 13.0	24	24	27	6	-	-	CAP186134	CAP186139
25	-	0.8	6.0 - 13.0	24	27	27	6	CAP187564	CAP187569	-	-
25	Pg 16	0.9	10.0 - 18.0	30	30	28	7	CAP187254	CAP187259	CAP186174	CAP186179
32	Pg 21	0.9	10.0 - 18.0	30	34	28	7	CAP187574	CAP187579	CAP186194	CAP186199
32	Pg 21	1.0	16.0 - 24.5	38	38	30	8	CAP187324	CAP187329	CAP186184	CAP186189
-	Pg 29	1.0	16.0 - 24.5	38	38	30	8	-	-	CAP186284	CAP186289
40	-	1.0	16.0 - 24.5	38	43	30	8	CAP187584	CAP187589	-	-
40	Pg 29	1.0	22.0 - 32.0	47	47	33	9	CAP187404	CAP187409	CAP186294	CAP186299
50	-	1.0	22.0 - 32.0	47	54	33	9	CAP187594	CAP187599	-	-
50	Pg 36	1.2	29.0 - 40.5	57	57	37	10	CAP187504	CAP187509	CAP186364	CAP186369
63	-	1.2	29.0 - 40.5	57	68	37	10	CAP187604	CAP187609	-	-
63	Pg 48 DIN	1.8	37.0 - 53.0	75	75	48	11	CAP187634	CAP187639	CAP186484	CAP186489
-	No 48 NFC	1.8	37.0 - 53.0	75	75	48	11	-	-	CAP186494	CAP186499

All dimensions in mm.

Capri NEWCAP - MS Multi-wired/Flat

Technical Specification

Suitable for the following cable types

- Non-armoured cable
- Multi-wire cable
- Flat cable

Certifications and Compliances

EN 50262

Product Specification

Material:

Nickel-plated brass for superior corrosion resistance.

Operating Temperature:

- Neoprene seal: -20°C to +80°C

Ingress Protection (IP)

- IP66/IP68 tested 30m/7days on surface Ra 1.6µm max.



SELECTION TABLE		DIMENSIONS			GLAND SIZE	CATALOG NUMBER
THREAD SIZE	CABLE DIAMETER MIN - MAX	NUMBER OF CABLES	A	L (LENGTH)		
ISO						
16	1.5 - 3.0	2	20	24	5	CAP187334
16	2.5 - 4.0	2	20	24	5	CAP187424
20	3.0 - 5.0	2	20	27	6	CAP187524
20	2.5 - 5.0	3	24	27	6	CAP187534
20	4.0 - 6.0	2	24	28	6	CAP187624
25	5.0 - 7.0	3	30	28	7	CAP187734
25	6.0 - 8.0	2	30	28	7	CAP187824
32	4.0 - 6.0	4	38	30	8	CAP187814
32	4.5 - 7.0	4	38	30	8	CAP187744
40	4.0 - 6.0	4	47	33	9	CAP187764

All dimensions in mm.

SELECTION TABLE		DIMENSIONS			GLAND SIZE	CATALOG NUMBER
THREAD SIZE	CABLE WIDTH MIN - MAX	CABLE THICKNESS MIN - MAX	A	L (LENGTH)		
ISO						
25	11.0 - 13.0	4.5 - 6.0	30	28	7	CAP187134
32	11.0 - 18.0	5.0 - 7.0	38	30	8	CAP187184
40	21.0 - 24.0	5.0 - 8.5	47	33	9	CAP187244
40	24.0 - 27.0	8.0 - 11.5	47	33	9	CAP187274
50	30.0 - 32.5	5.0 - 9.0	57	37	10	CAP187304
50	29.0 - 31.0	10.0 - 14.0	57	37	10	CAP187314
50	32.5 - 35.5	9.0 - 12.0	57	37	10	CAP187354
50	34.0 - 37.0	4.5 - 6.5	57	37	10	CAP187374
50	38.0 - 40.0	10.0 - 14.0	57	48	10	CAP187414
63	38.0 - 42.0	4.5 - 6.5	75	48	11	CAP187444

All dimensions in mm.

NEWCAP - MS Multi-wired

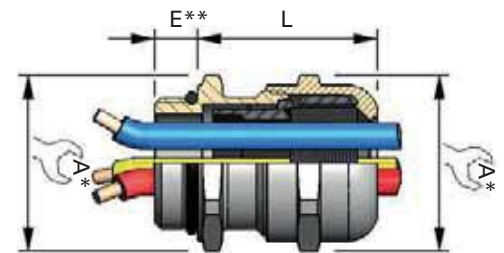

NEWCAP - MS Flat

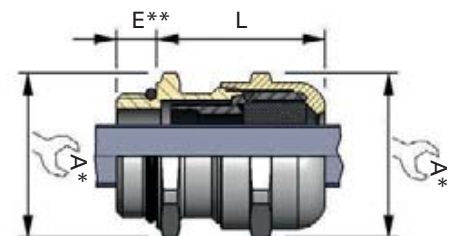

* For 'across corners' dimensions, multiply 'across flats' dimensions by 1.1

** For 'E' see Thread Dimension page 87

Technical Specification

Suitable for the following cable types

- Non-armoured cable
- Shielded cable for EMC specific cable and applications

Certifications and Compliances

EN 50262

Product Specification

Material:

Nickel-plated brass for superior corrosion resistance.

Operating Temperature:

- Neoprene seal: -20°C to +80°C

Ingress Protection (IP)

- IP66/IP68 tested 30m/7days on surface Ra 1.6µm max.

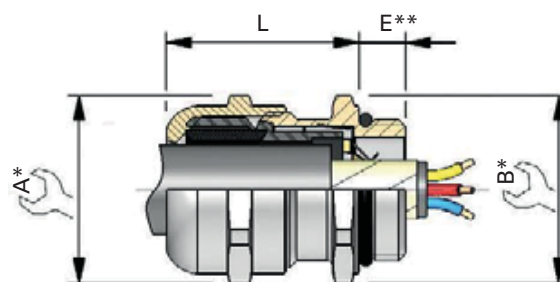

* For 'across corners' dimensions, multiply 'across flats' dimensions by 1.1



** For 'E' see Thread Dimension page 87

SELECTION TABLE				DIMENSIONS				GLAND SIZE	CATALOG NUMBER ISO (NICKEL-PLATED BRASS)	CATALOG NUMBER Pg (NICKEL-PLATED BRASS)
THREAD SIZE	THREAD SIZE	BRAID THICKNESS	DIAMETER ON SHIELD	CABLE DIAMETER MIN - MAX	A	B	L (LENGTH)			
ISO	Pg									
12	Pg 7	0.7	3.0	3.0 - 6.5	15	15	18	4	CAP189124	CAP169074
16	-	0.7	3.0	3.0 - 6.5	15	18	18	4	CAP189544	-
16	Pg 9	0.7	4.5	4.5 - 10.0	20	20	24	5	CAP189164	CAP169094
20	-	0.7	4.5	4.5 - 10.0	20	22	24	5	CAP189554	-
20	Pg 11	0.8	6.0	6.0 - 13.0	24	24	27	6	CAP189204	CAP169114
-	Pg 13	0.8	6.0	6.0 - 13.0	24	24	27	6	-	CAP169134
25	-	0.8	6.0	6.0 - 13.0	24	27	27	6	CAP189564	-
25	Pg 16	0.9	10.0	10.0 - 18.0	30	30	28	7	CAP189254	CAP169164
32	Pg 21	0.9	10.0	10.0 - 18.0	30	34	28	7	CAP189574	CAP169194
32	Pg 21	1.0	15.0	16.0 - 24.5	38	38	30	8	CAP189324	CAP169214
-	Pg 29	1.0	15.0	16.0 - 24.5	38	38	30	8	-	CAP169284
40	-	1.0	15.0	16.0 - 24.5	38	43	30	8	CAP189584	-
40	Pg 29	1.0	20.5	22.0 - 32.0	47	47	33	9	CAP189404	CAP169294
50	-	1.0	20.5	22.0 - 32.0	47	54	33	9	CAP189594	-
50	Pg 36	1.2	27.5	29.0 - 40.5	57	57	37	10	CAP189504	CAP169364
63	-	1.2	27.5	29.0 - 40.5	57	68	37	10	CAP189604	-
63	Pg 48 DIN	1.8	34.5	37.0 - 53.0	75	75	48	11	CAP189634	CAP169484
-	No 48 NFC	1.8	34.5	37.0 - 53.0	75	75	48	11	-	CAP169494

All dimensions in mm.

Technical Specification

Suitable for the following cable types

-  Steel wire armoured cable (SWA)
-  Steel wire braided cable (SWB)
-  Steel tape armoured cable (STA)

Features

- Standard nickel-plated brass material for superior corrosion resistance
- Armour clamping and bonding with no reversible components for easy installation, minimizing error
- Provides the sealing on the inner and outer sheath of the armoured cables
- Continuous use temperature: from -20°C to +100°C
- Available with metric or NPT threads

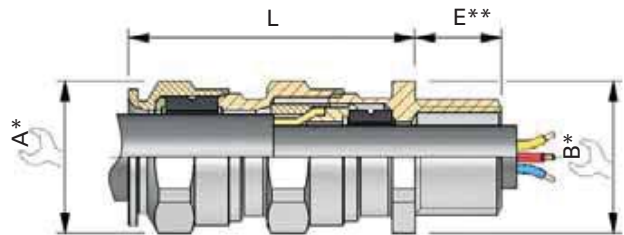

* For 'across corners' dimensions, multiply 'across flats' dimensions by 1.1

** For 'E' see Thread Dimension page 87

SELECTION TABLE					DIMENSIONS					GLAND SIZE	CATALOG NUMBER ISO	CATALOG NUMBER NPT	
SERIES	THREAD SIZE		THREAD SIZE		CABLE SEALING RANGE ISO/(NPT)		MAX ARMOUR THICKNESS	A	B				L (LENGTH)
	ISO		NPT		INNER SHEATH MIN - MAX	OUTER SHEATH MIN - MAX							
ADE4i	12		1/4"		4.0 - 8.0	6.0 - 12.0	0.2 - 0.9	19	19	36	5	CAP946404	CAP948404
ADE4i	16		3/8"		4.0 - 8.5	6.0 - 12.0	0.2 - 0.9	19	19	36	5	CAP946594	CAP948594
ADE4i	16		3/8"		6.0 - 12.0	8.5 - 16.0	0.2 - 1.3	24	24	42	6	CAP946504	CAP948504
ADE4i	20		1/2"		4.0 - 8.5	6.0 - 12.0	0.2 - 0.9	19	24	36	5	CAP946674	CAP948674
ADE4i	20		1/2"		6.0 - 12.0	8.5 - 16.0	0.2 - 1.3	24	24	42	6	CAP946694	CAP948694
ADE4i	20		1/2"		8.5 - 16.0	12.0 - 21.0	0.2 - 1.3	30	30	46	7	CAP946604	CAP948604
ADE4i	25		3/4"		6.0 - 12.0	8.5 - 16.0	0.2 - 1.3	19	30	42	6	CAP946774	CAP948774
ADE4i	25		3/4"		8.5 - 16.0	12.0 - 21.0	0.2 - 1.3	24	30	46	7	CAP946794	CAP948794
ADE4i	25		3/4"		12.0 - 20.5	16.0 - 27.5	0.2 - 1.6	30	41	56	8	CAP946704	CAP948704
ADE4i	32		1"		12.0 - 21.0	16.0 - 27.5	0.2 - 1.6	41	41	56	8	CAP946894	CAP948894
ADE4i	32		1"		16.0 - 27.5	21.0 - 34.0	0.2 - 1.6	41	48	63	9	CAP946804	CAP948804
ADE4i	40		1 1/4"		16.0 - 27.5	21.0 - 34.0	0.2 - 1.6	48	48	63	9	CAP946994	CAP948994
ADE4i	40		1 1/4"		21.0 - 34.0	27.0 - 41.0	0.2 - 2.0	48	55	68	10	CAP946904	CAP948904
ADE4i	50		1 1/2"		21.0 - 34.0	27.0 - 41.0	0.2 - 2.0	55	55	68	10	CAP947094	CAP949904
ADE4i	50		1 1/2"		27.0 - 41.0	33.0 - 48.0	0.2 - 2.5	55	64	74	11	CAP947004	CAP949004
ADE4i	63		2"		27.0 - 41.0	33.0 - 48.0	0.2 - 2.5	64	72	77	12	CAP947294	CAP949294
ADE4i	63		2"		33.0 - 48.0	40.0 - 56.0	0.2 - 2.5	72	85	85	13	CAP947204	CAP949204
ADE4i	75		2 1/2"		40.0 - 56.0	47.0 - 65.0	0.2 - 2.5	85	85	85	13	CAP947394	CAP949394
ADE4i	75		2 1/2"		47.0 - 65.0	54.0 - 74.0	0.2 - 2.5	85	95	92	14	CAP947304	CAP949404
ADE4i	90		3"		54.0 - 74.0	63.0 - 83.0	0.2 - 3.2	95	110	104	15	CAP947594	CAP949564
ADE4i	90		3"		63.0 - 82.0	72.0 - 93.0	0.2 - 3.2	110	120	108	16	CAP947504	CAP949504
ADE4i	-		3 1/2"		63.0 - 82.0	72.0 - 93.0	0.2 - 3.2	120	120	108	16	-	CAP949604
ADE4i	110		4"		72.0 - 92.0	85.0 - 107.0	0.2 - 3.2	135	135	115	17	CAP947794	CAP949704

All dimensions in mm.

Technical Specification

Suitable for the following cable types

➡ Non-armoured round cable

Features

- Material: nylon 6/6 - UL 94 V0 - Halogen-free
- Color: grey RAL 7035 or black RAL 9005
- Neoprene sealing ring
- Maximum operating temperature: +150°C
- Continuous operating temperature: -40°C to +100°C
- IP68: 5 bars without sealing washer except Pg 36/42/48 and ISO40/50/63 according to NF EN 60529
- Entry thread metric: ISO-NF EN 60423 and NF EN 50262
- Entry thread electrical guide: UTE C 68-311 - DIN 40430

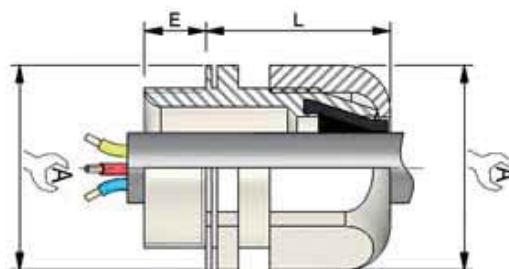

* For 'across corners' dimensions, multiply 'across flats' dimensions by 1.1

SELECTION TABLE		DIMENSIONS				GLAND		SEALING WASHER	LOCKNUT	
SERIES	THREAD SIZE	CABLE DIAMETER MIN - MAX	A	L (LENGTH)	E (THREAD LENGTH)	CATALOG NUMBER GREY COLOR	CATALOG NUMBER BLACK COLOR	CATALOG NUMBER	CATALOG NUMBER GREY COLOR	CATALOG NUMBER BLACK COLOR
	ISO									
EUROCAP	12	3.5 - 6.5	15	21	8	CAP401270	CAP401260	CAP221249	CAP261273	CAP261203
EUROCAP	16	4.0 - 8.0	19	25	8	CAP401670	CAP401660	CAP221649	CAP261673	CAP261603
EUROCAP	20	6.0 - 12.0	24	33	9	CAP402070	CAP402060	CAP222049	CAP262073	CAP262003
EUROCAP	25	12.0 - 18.0	32	36	11	CAP402570	CAP402560	CAP222549	CAP262573	CAP262503
EUROCAP	32	17.0 - 25.0	42	40	11	CAP403270	CAP403260	CAP223249	CAP263273	CAP263203
EUROCAP	40*	20.0 - 32.0	53	36	11	CAP404070	CAP404060	CAP224049*	CAP264073	CAP264003
EUROCAP	50*	26.0 - 38.0	60	36	11	CAP405070	CAP405060	CAP225049*	CAP265073	CAP265003
EUROCAP	63*	30.0 - 44.0	68	36	11	CAP406370	CAP406360	CAP226349*	CAP266373	CAP266303

* Delivered with sealing washer. All dimensions in mm.

SELECTION TABLE		DIMENSIONS				GLAND		SEALING WASHER	LOCKNUT	
SERIES	THREAD SIZE	CABLE DIAMETER MIN - MAX	A	L (LENGTH)	E (THREAD LENGTH)	CATALOG NUMBER GREY COLOR	CATALOG NUMBER BLACK COLOR	CATALOG NUMBER	CATALOG NUMBER GREY COLOR	CATALOG NUMBER BLACK COLOR
	ISO									
EUROCAP	Pg 7	3.5 - 6.5	15	21	8	CAP410770	CAP410760	CAP240749	CAP260770	CAP260760
EUROCAP	Pg 9	4.0 - 8.0	19	25	8	CAP410970	CAP410960	CAP240949	CAP260970	CAP260960
EUROCAP	Pg 11	5.0 - 10.0	22	29	8	CAP411170	CAP411160	CAP241149	CAP261170	CAP261160
EUROCAP	Pg 13	6.0 - 12.0	24	33	9	CAP411370	CAP411360	CAP241349	CAP261370	CAP261360
EUROCAP	Pg 16	9.0 - 14.0	27	34	10	CAP411670	CAP411660	CAP241649	CAP261670	CAP261660
EUROCAP	Pg 21	12.0 - 18.0	33	36	11	CAP412170	CAP412160	CAP242149	CAP262170	CAP262160
EUROCAP	Pg 29*	17.0 - 25.0	42	40	11	CAP412970	CAP412960	CAP242949*	CAP262970	CAP262960
EUROCAP	Pg 36*	20.0 - 32.0	53	51	13	CAP413670	CAP413660	CAP243649*	CAP263670	CAP263660
EUROCAP	Pg 42*	26.0 - 38.0	60	50	13	CAP414270	CAP414260	CAP244249*	CAP264270	CAP264260
EUROCAP	Pg 48 DIN*	30.0 - 44.0	65	53	14	CAP414870	CAP414860	CAP244849*	CAP264878	CAP264879

* Delivered with sealing washer. All dimensions in mm.

Technical Specification

Suitable for the following cable types

➡ Non-armoured round cable

Features

- Material: nylon
- Color: grey RAL 7035
- Operculated PVC colored plasticized sealing ring
- Continuous operating temperature: -5°C to +70°C
- PVC hardening temperature: -20°C
- IP68: 5 bars without sealing washer provided if the bearing area is satisfactory
- Entry thread metric: ISO-NF EN 60423 and NF EN 50262
- Entry thread electrical guide: UTE C 68-311 - DIN 40430

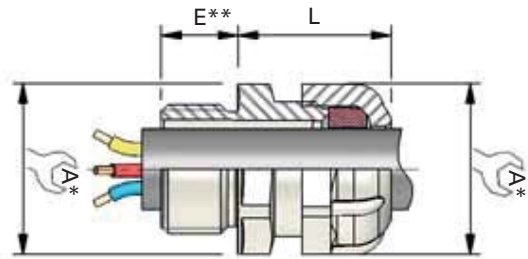

* For 'across corners' dimensions, multiply 'across flats' dimensions by 1.1

SELECTION TABLE		DIMENSIONS				SEALING RING COLOR	GLAND	SEALING WASHER	LOCKNUT
SERIES	THREAD SIZE ISO	CABLE DIAMETER MIN - MAX	A	L (LENGTH)	E (THREAD LENGTH)		CATALOG NUMBER	CATALOG NUMBER	CATALOG NUMBER
ECP	12	3.0 - 6.0	15	18	8		CAP439120	CAP221249	CAP261273
ECP	16	4.0 - 8.0	19	22	8		CAP439160	CAP221649	CAP261673
ECP	16 Bis	5.0 - 10.0	22	22	8		CAP439170	CAP221649	CAP261673
ECP	20	7.5 - 13.0	24	23	9		CAP439200	CAP222049	CAP262073
ECP	20 Bis	9.5 - 15.0	26	23	9		CAP439210	CAP222049	CAP262073
ECP	25	13.0 - 19.0	32	29	11		CAP439250	CAP222549	CAP262573
ECP	32	15.0 - 25.0	41	29	11		CAP439320	CAP223249	CAP263273
ECP	40	21.0 - 32.0	52	35	13		CAP439400	CAP224049	CAP264073
ECP	50	26.0 - 38.0	59	40	13		CAP439500	CAP225049	CAP265073
ECP	63	31.0 - 44.0	65	42	14		CAP439630	CAP226349	CAP266373

All dimensions in mm.

SELECTION TABLE		DIMENSIONS				SEALING RING COLOR	GLAND	SEALING WASHER	LOCKNUT
SERIES	THREAD SIZE PG	CABLE DIAMETER MIN - MAX	A	L (LENGTH)	E (THREAD LENGTH)		CATALOG NUMBER	CATALOG NUMBER	CATALOG NUMBER
ECP	Pg 7	3.0 - 6.0	15	18	9		CAP430070	CAP240749	CAP260770
ECP	Pg 9	4.0 - 8.0	19	22	9		CAP430090	CAP240949	CAP260970
ECP	Pg 11	5.0 - 10.0	22	22	9		CAP430110	CAP241149	CAP261170
ECP	Pg 13	7.5 - 13.0	24	23	10		CAP430130	CAP241349	CAP261370
ECP	Pg 16	9.5 - 15.0	28	23	10		CAP430160	CAP241649	CAP261670
ECP	Pg 21	13.0 - 19.0	32	29	11		CAP430210	CAP242149	CAP262170
ECP	Pg 29*	15.0 - 25.0	41	29	12		CAP430290	CAP242949	CAP262970
ECP	Pg 36*	21.0 - 32.0	52	35	14		CAP430360	CAP243649	CAP263670
ECP	Pg 42*	26.0 - 38.0	59	40	16		CAP430420	CAP244249	CAP264270
ECP	No 48 NFC	31.0 - 44.0	65	42	18		CAP430480	CAP244849	CAP264878
ECP	Pg 48 DIN*	31.0 - 44.0	65	42	18		CAP437480	CAP244849	CAP264878

All dimensions in mm.

Technical Specification

Suitable for the following cable types

➡ Non-armoured cable

Certifications and Compliances

EN 50262

Product Specification

Material: nylon

Color: grey RAL 7035

Operculated thermoplastic sealing ring.

Operating Temperature:

- Maximum temperature: +150°C
- Continuous operating temperature: -40°C to +100°C

Ingress Protection (IP)

- IP68: 5 bars without sealing washer provided if the bearing area is satisfactory
- Entry thread metric: ISO-NF EN 60423 and NF EN 50262
- Entry thread Pg: UTE C 68-311 - DIN 40430

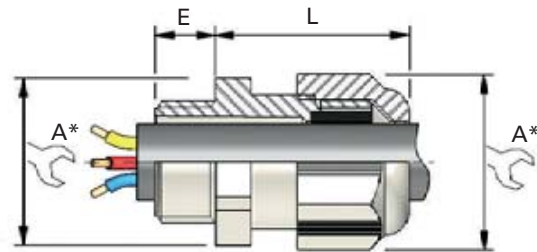

* For 'across corners' dimensions, multiply 'across flats' dimensions by 1.1

SELECTION TABLE		DIMENSIONS				CATALOG NUMBER ISO	CATALOG NUMBER Pg
THREAD SIZE ISO	THREAD SIZE Pg	CABLE DIAMETER MIN - MAX	A	L ISO / PG	E ISO / PG		
M12	Pg 7	3.0 - 6.5	15	14	8	CAP451202	CAP450702
-	Pg 9	4.0 - 8.0	19	28	8	-	CAP450902
M16	Pg 11	5.0 - 10.0	22	28 / 29	10 / 8	CAP451602	CAP451102
M20	Pg 13	6.0 - 12.0	24	29	10 / 9	CAP452002	CAP451302
-	Pg 16	10.0 - 14.0	27	33	9	-	CAP451602
M25	Pg 21	12.0 - 18.0	33	38	10 / 11	CAP452502	CAP452102
M32	Pg 29	18.0 - 25.0	42	41	10 / 11	CAP453202	CAP452902
M40	Pg 36	22.0 - 32.0	53	52	10 / 13	CAP454002	CAP453602
M50	Pg 42	30.0 - 38.0	60	54	18 / 13	CAP455002	CAP454202
M63	Pg 48 DIN	34.0 - 44.0	65	55	18 / 14	CAP456302	CAP454802

All dimensions in mm.

SELECTION TABLE		DIMENSIONS				CATALOG NUMBER ISO (FITTED WITH MOUNTING NUT)	CATALOG NUMBER Pg (FITTED WITH MOUNTING NUT)	CATALOG NUMBER ISO (WITH MOUNTING NUT - NOT FITTED)	CATALOG NUMBER Pg (WITH MOUNTING NUT - NOT FITTED)
THREAD SIZE ISO	THREAD SIZE Pg	CABLE DIAMETER MIN - MAX	A	L ISO / PG	E ISO / PG				
M12	PG7	3.0 - 6.5	15	14	8	CAP451212	CAP450712	CAP451272	CAP450772
-	PG9	4.0 - 8.0	19	28	8	-	CAP450912	-	CAP450972
M16	PG11	5.0 - 10.0	22	28 / 29	10 / 8	CAP451612	CAP451112	CAP451672	CAP451172
M20	PG13	6.0 - 12.0	24	29	10 / 9	CAP452012	CAP451312	CAP452072	CAP451372
-	PG16	10.0 - 14.0	27	33	9	-	CAP451612	-	CAP451672
M25	PG21	12.0 - 18.0	33	38	10 / 11	CAP452512	CAP452112	CAP452572	CAP452172
M32	PG29	18.0 - 25.0	42	41	10 / 11	CAP453212	CAP452912	CAP453272	CAP452972
M40	PG36	22.0 - 32.0	53	52	10 / 13	CAP454012	CAP453612	CAP454072	CAP453672
M50	PG42	30.0 - 38.0	60	54	18 / 13	CAP455012	CAP454212	CAP455072	CAP454272
M63	PG48 DIN	34.0 - 44.0	65	55	18 / 14	CAP456312	CAP454812	CAP456372	CAP454872



All dimensions in mm.

CGD - for Non-armoured Cable

Technical Specification



Suitable for the following cable types

-  Non-armoured cable
-  Tray cable

Certifications and Compliances

cULus Listed: UL File E23223

Product Specification

Material:

45° angle with male thread.
 Standard body material is Feraloy® iron alloy.
 Standard gland nut material is steel.
 Weatherproof seal on outer sheath of cable.
 Standard neoprene seal suitable for use in operating temperatures -25° to +40°C.
 Available with NPT threads.

Operating Temperature:

- -25°C to +40°C

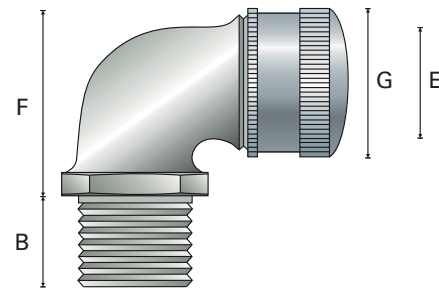

SELECTION TABLE	DIMENSIONS				CATALOG NUMBER NPT
THREAD SIZE	OUTER SHEATH 'E' MIN - MAX	EXTERNAL DIAMETER 'G'	GLAND LENGTH 'F' LESS ENTRY	THREAD LENGTH 'B'	
NPT					
1/2"	0.12 - 0.25	1.19	1.69	0.63	CGD192
1/2"	0.25 - 0.37	1.19	1.69	0.63	CGD193
1/2"	0.37 - 0.50	1.19	1.69	0.63	CGD194
1/2"	0.50 - 0.62	1.19	1.69	0.63	CGD195
1/2"	0.62 - 0.75	1.63	2.06	0.63	CGD196
1/2"	0.75 - 0.87	1.63	2.06	0.63	CGD197
3/4"	0.12 - 0.25	1.14	1.94	0.63	CGD292
3/4"	0.25 - 0.37	1.14	1.94	0.63	CGD293
3/4"	0.37 - 0.50	1.13	1.94	0.63	CGD294
3/4"	0.50 - 0.62	1.13	1.94	0.63	CGD295
3/4"	0.62 - 0.75	1.63	2.00	0.63	CGD296
3/4"	0.75 - 0.87	1.63	2.00	0.63	CGD297

All dimensions in inches unless otherwise stated.

CGB - for Non-armoured Cable

Technical Specification



Suitable for the following cable types

- Non-armoured cable
- Tray cable

Certifications and Compliances

cULus Listed - UL File No. E23223

Product Specification

Material:

Form A - D bodies and gland nuts - steel with zinc electroplate and chromate finish coat.
Form E - F bodies and gland nuts - Feraloy® iron alloy with electrogalvanized and aluminum acrylic paint.
Weatherproof seal on outer sheath of cable.
Available with NPT threads.
Available in all aluminum construction.

Operating Temperature:

- Standard neoprene seal: -25°C to +40°C

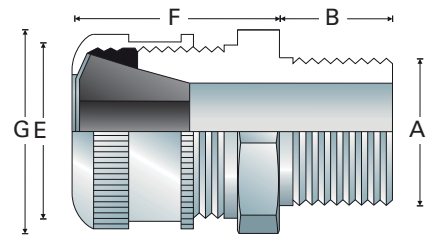

CGB - for Non-armoured Cable

Technical Specification

SELECTION TABLE		DIMENSIONS						CATALOG NUMBER NPT
THREAD SIZE A	FORM	OUTER SHEATH 'E' MIN - MAX	EXTERNAL DIAMETER 'G'	ACROSS FLATS	ACROSS CORNERS 'G'	GLAND LENGTH 'F' LESS ENTRY	THREAD LENGTH 'B' NPT	
NPT								
3/8"	A	0.12 - 0.25	-	0.75	0.88	1.06	0.44	CGB3814
3/8"	A	0.25 - 0.37	-	0.75	0.88	1.06	0.44	CGB3816
3/8"	A	0.37 - 0.44	-	0.75	0.88	1.06	0.44	CGB3817
3/8"	B	0.12 - 0.25	-	1.00	1.19	1.31	0.44	CGB3892
3/8"	B	0.25 - 0.37	-	1.00	1.19	1.31	0.44	CGB3893
3/8"	B	0.37 - 0.50	-	1.00	1.19	1.31	0.44	CGB3894
1/2"	A	0.12 - 0.25	-	0.88	1.19	1.00	0.62†	CGB114†
1/2"	A	0.25 - 0.37	-	0.88	1.19	1.00	0.62†	CGB116†
1/2"	A	0.37 - 0.44	-	0.88	1.19	1.00	0.62†	CGB117†
1/2"	B	0.12 - 0.25	-	1.00	1.19	1.31	0.75*†	CGB192*†
1/2"	B	0.25 - 0.37	-	1.00	1.19	1.31	0.75*†	CGB193*†
1/2"	B	0.37 - 0.50	-	1.00	1.19	1.31	0.75*†	CGB194*†
1/2"	B	0.50 - 0.62	-	1.00	1.19	1.31	0.75*†	CGB195*†
1/2"	C	0.62 - 0.75	-	1.50	1.66	1.75	0.62*	CGB196*
1/2"	C	0.75 - 0.87	-	1.50	1.66	1.75	0.62*†	CGB197*†
3/4"	B	0.12 - 0.25	-	1.06	1.25	1.38	0.62†	CGB292†
3/4"	B	0.25 - 0.37	-	1.06	1.25	1.38	0.62†	CGB293†
3/4"	B	0.37 - 0.50	-	1.06	1.25	1.38	0.62†	CGB294†
3/4"	B	0.50 - 0.62	-	1.06	1.25	1.38	0.62†	CGB295†
3/4"	C	0.62 - 0.75	-	1.63	1.66	1.75	0.62*†	CGB296*†
3/4"	C	0.75 - 0.87	-	1.63	1.66	1.75	0.62*†	CGB297*†
3/4"	D	0.87 - 1.00	2.25	-	-	2.50	0.62*†	CGB298*†
1"	B	0.25 - 0.37	-	1.38	1.65	1.38	0.69†	CGB393†
1"	B	0.37 - 0.50	-	1.38	1.65	1.38	0.69†	CGB394†
1"	C	0.50 - 0.62	-	1.50	1.88	1.69	0.69*†	CGB395*†
1"	C	0.62 - 0.75	-	1.50	1.88	1.69	0.69*†	CGB396*†
1"	C	0.75 - 0.87	-	1.50	1.88	1.69	0.69*†	CGB397*†
1"	C	0.87 - 1.00	-	-	1.88	1.69	0.69†	CGB3239†
1"	D	0.87 - 1.00	2.38	-	-	2.38	0.62*†	CGB398*†
1"	D	1.00 - 1.19	2.38	-	-	2.38	0.62*†	CGB399*†
1"	D	1.19 - 1.37	2.38	-	-	2.38	0.62*†	CGB3911*†
1 1/4"	D	0.87 - 1.00	2.25	-	-	2.31	0.69	CGB498
1 1/4"	D	1.00 - 1.19	2.25	-	-	2.31	0.69	CGB499
1 1/4"	D	1.19 - 1.37	2.25	-	-	2.31	0.69	CGB4911
1 1/4"	E	1.37 - 1.62	3.00	-	-	2.63	0.69	CGB4913
1 1/4"	E	1.62 - 1.87	3.00	-	-	2.63	0.69	CGB4915
1 1/2"	D	0.87 - 1.00	2.25	-	-	2.31	0.81	CGB598
1 1/2"	D	1.00 - 1.19	2.25	-	-	2.31	0.81	CGB599
1 1/2"	D	1.19 - 1.37	2.25	-	-	2.31	0.81	CGB5911
1 1/2"	E	1.37 - 1.62	3.00	-	-	2.63	0.81	CGB5913
1 1/2"	E	1.62 - 1.87	3.00	-	-	2.63	0.81	CGB5915
2"	E	1.37 - 1.62	3.00	-	-	2.63	0.81	CGB6913
2"	E	1.62 - 1.87	3.00	-	-	2.63	0.81	CGB6915
2"	F	1.87 - 2.19	3.75	-	-	2.56	0.81	CGB6917
2"	F	2.19 - 2.50	3.75	-	-	2.56	0.81	CGB6920
2 1/2"	E	1.37 - 1.62	3.13	-	-	2.63	1.00	CGB7913
2 1/2"	E	1.62 - 1.87	3.13	-	-	2.63	1.00	CGB7915
2 1/2"	F	1.87 - 2.19	3.75	-	-	2.63	1.00	CGB7917
2 1/2"	F	2.19 - 2.50	3.75	-	-	2.63	1.00	CGB7920
3"	F	1.87 - 2.19	3.75	-	-	2.63	1.00	CGB8917
3"	F	2.19 - 2.50	3.75	-	-	2.63	1.00	CGB8920

All dimensions in inches unless otherwise stated.

† With optional aluminum construction.

* With optional sealing gasket.

CGE - for Non-armoured Cable

Technical Specification



Suitable for the following cable types

☞ Non-armoured cable

Certifications and Compliances

cULus Listed - UL File No. E23223

Product Specification

Material:

90° angle with male thread.

Standard body material is Feraloy® iron alloy.

Standard gland nut material is steel.

Weatherproof seal on outer sheath of cable.

Standard neoprene seal suitable for use in operating temperatures -25° to +40°C.

Available with NPT threads.

Operating Temperature:

- -25°C to +40°C

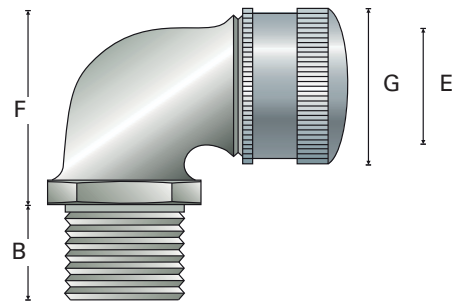

SELECTION TABLE		DIMENSIONS			CATALOG NUMBER NPT
THREAD SIZE	OUTER SHEATH 'E' MIN - MAX	EXTERNAL DIAMETER 'G'	GLAND LENGTH 'F' LESS ENTRY	THREAD LENGTH 'B' NPT	
1/2"	0.12 - 0.25	1.19	1.44	0.71	CGE192
1/2"	0.25 - 0.37	1.19	1.44	0.71	CGE193
1/2"	0.37 - 0.50	1.19	1.44	0.71	CGE194
1/2"	0.50 - 0.62	1.19	1.44	0.71	CGE195
1/2"	0.62 - 0.75	1.63	2.00	0.71	CGE196
1/2"	0.75 - 0.87	1.63	2.00	0.71	CGE197
3/4"	0.12 - 0.25	1.19	1.41	0.71	CGE292
3/4"	0.25 - 0.37	1.19	1.41	0.71	CGE293
3/4"	0.37 - 0.50	1.19	1.41	0.71	CGE294
3/4"	0.50 - 0.62	1.19	1.41	0.71	CGE295
3/4"	0.62 - 0.75	1.63	1.88	0.71	CGE296
3/4"	0.75 - 0.87	1.63	1.88	0.71	CGE297
1"	0.50 - 0.62	1.63	2.06	0.71	CGE395
1"	0.62 - 0.75	1.63	2.09	0.71	CGE396
1"	0.75 - 0.87	1.63	2.09	0.71	CGE397
1"	0.87 - 1.00	2.25	2.09	0.71	CGE3239
1"	0.87 - 1.00	2.25	2.66	0.71	CGE398
1"	1.00 - 1.19	1.63	2.66	0.71	CGE399
1"	1.19 - 1.37	2.25	2.66	0.71	CGE3911

All dimensions in inches unless otherwise stated.

Capri Industrial Accessories

Features

Features

- Material: nickel-plated brass/316L stainless steel (316L stainless steel: replace last digit by 9)
- Electrical thread Pg - Standard Guide UTE C 68-311 - DIN 40430
- Adapters, plugs and reducers: IP66, IP68 with fiber or neoprene sealing washer

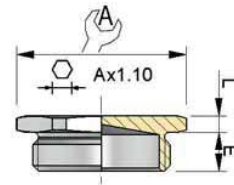
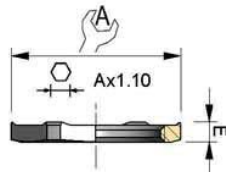
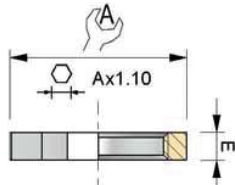

LOCKNUT			CATALOG NUMBER
Pg	A	E	
Pg 7	15.0	3.0	CAP280704
Pg 9	18.0	3.0	CAP280904
Pg 11	21.0	3.0	CAP281104
Pg 13	23.0	3.0	CAP281304
Pg 16	26.0	3.0	CAP281604
Pg 21	32.0	3.5	CAP282104
Pg 29	41.0	4.0	CAP282904
Pg 36	51.0	5.0	CAP283604
Pg 42	58.0	5.0	CAP284204
N°48 NFC	64.0	6.0	CAP284804
Pg 48 DIN	64.0	6.0	CAP284884

EARTHING LOCKNUT			CATALOG NUMBER
Pg	A	E	
Pg 7	15.0	3.0	CAP280794
Pg 9	18.0	3.0	CAP280994
Pg 11	21.0	3.0	CAP281194
Pg 13	23.0	3.0	CAP281394
Pg 16	26.0	3.0	CAP281694
Pg 21	32.0	3.5	CAP282194
Pg 29	41.0	4.0	CAP282994
Pg 36	51.0	5.0	CAP283694
Pg 42	58.0	5.0	CAP284294
N°48 NFC	64.0	6.0	CAP284894
Pg 48 DIN	64.0	6.0	CAP284994

STOPPING PLUG				CATALOG NUMBER
Pg	A	L	E	
Pg 7	15.0	2.5	6.5	CAP190704
Pg 9	18.0	2.5	6.5	CAP190904
Pg 11	21.0	3.0	7.0	CAP191104
Pg 13	23.0	3.0	7.0	CAP191304
Pg 16	26.0	3.5	7.0	CAP191604
Pg 21	32.0	4.0	8.0	CAP192104
Pg 29	41.0	4.0	8.5	CAP192904
Pg 36	51.0	5.0	8.5	CAP193604
Pg 42	58.0	6.0	10.0	CAP194204
N°48 NFC	64.0	6.5	11.0	CAP194804
Pg 48 DIN	64.0	6.5	11.0	CAP194884

All dimensions in mm.

All dimensions in mm.

All dimensions in mm.

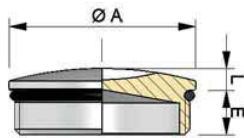

DOME HEAD				CATALOG NUMBER
Pg	ØA	L	E	
Pg 7	14.0	2.5	6.5	CAP196074
Pg 9	17.0	2.5	6.5	CAP196094
Pg 11	20.0	3.0	7.0	CAP196114
Pg 13	22.0	3.0	7.0	CAP196134
Pg 16	24.0	3.5	7.0	CAP196174
Pg 21	30.0	4.0	8.0	CAP196214
Pg 29	39.0	4.0	8.5	CAP196294
Pg 36	50.0	5.0	8.5	CAP196364
Pg 42	57.0	6.0	10.0	CAP196424
N°48 NFC	64.0	6.5	11.0	CAP196484
Pg 48 DIN	64.0	6.5	11.0	CAP196494

All dimensions in mm.

ADAPTER						CATALOG NUMBER
Pg M	Pg F	A	L	E	ØD	
Pg 7	Pg 9	17.0	7.5	4.0	10.0	CAP070904
Pg 9	Pg 11	20.0	8.5	5.0	12.0	CAP091104
Pg 9	Pg 13	22.0	8.5	5.0	12.0	CAP091304
Pg 11	Pg 13	22.0	8.5	6.0	15.0	CAP111304
Pg 11	Pg 16	24.0	8.5	6.0	15.0	CAP111604
Pg 13	Pg 16	24.0	8.5	6.0	16.5	CAP131604
Pg 13	Pg 21	30.0	8.5	6.0	16.5	CAP132104
Pg 16	Pg 21	30.0	10.0	6.0	18.5	CAP162104
Pg 21	Pg 29	40.0	11.5	7.0	24.0	CAP212904
Pg 29	Pg 36	50.0	11.5	8.0	32.0	CAP293604
Pg 36	Pg 42	58.0	15.0	8.0	41.0	CAP364204
Pg 36	N°48 NFC	64.0	15.0	8.0	41.0	CAP364804
Pg 42	N°48 NFC	64.0	15.0	8.0	48.0	CAP424804
Pg 36	Pg 48 DIN	64.0	15.0	8.0	41.0	CAP364884
Pg 42	Pg 48 DIN	64.0	15.0	8.0	48.0	CAP424884

All dimensions in mm.

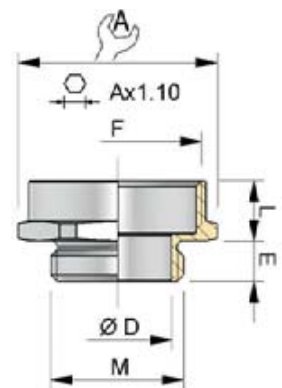

Technical Specification

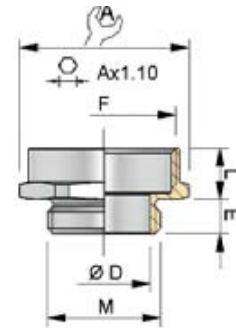
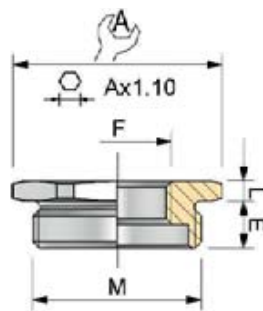
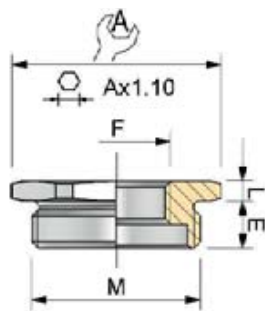

REDUCER					CATALOG NUMBER
Pg M	Pg F	A	L	E	
Pg 9	Pg 7	16.0	2.0	5.0	CAP090704
Pg 11	Pg 7	20.0	2.0	6.0	CAP110704
Pg 11	Pg 9	20.0	2.0	6.0	CAP110904
Pg 13	Pg 9	22.0	2.5	6.0	CAP130904
Pg 13	Pg 11	22.0	2.5	6.0	CAP131104
Pg 16	Pg 9	24.0	2.5	6.0	CAP160904
Pg 16	Pg 11	24.0	2.5	6.0	CAP161104
Pg 16	Pg 13	24.0	2.5	6.0	CAP161304
Pg 21	Pg 9	30.0	3.0	7.0	CAP210904
Pg 21	Pg 11	30.0	3.0	7.0	CAP211104
Pg 21	Pg 13	30.0	3.0	7.0	CAP211304
Pg 21	Pg 16	30.0	3.0	7.0	CAP211604
Pg 29	Pg 16	38.0	3.0	8.0	CAP291604
Pg 29	Pg 21	38.0	3.0	8.0	CAP292104
Pg 36	Pg 21	38.0	3.5	8.0	CAP362104
Pg 36	Pg 29	48.0	3.5	8.0	CAP362904
Pg 42	Pg 29	58.0	4.0	10.0	CAP422904
Pg 42	Pg 36	58.0	4.0	10.0	CAP423604
N°48 NFC	Pg 29	62.0	4.0	10.0	CAP482904
N°48 NFC	Pg 36	62.0	4.0	10.0	CAP483604
N°48 NFC	Pg 42	62.0	4.0	10.0	CAP484204
Pg 48 DIN	Pg 36	62.0	4.0	10.0	CAP483684
Pg 48 DIN	Pg 42	62.0	4.0	10.0	CAP484284

All dimensions in mm.

REDUCER							CATALOG NUMBER
Pg M	ISO F	A	L	E	ØD	TYPE	
Pg 7	12	14.0	7.0	6.5	9.8	1	CAP751774
Pg 7	16	19.0	8.5	6.5	9.8	1	CAP750094
Pg 9	12	19.0	2.5	6.5	-	2	CAP751844
Pg 9	16	19.0	8.5	6.5	12.0	1	CAP750104
Pg 9	20	22.0	8.5	6.5	12.0	1	CAP750364
Pg 11	12	21.0	3.0	7.0	-	2	CAP751874
Pg 11	16	21.0	7.5	7.0	-	2	CAP750114
Pg 11	20	22.0	8.5	7.0	15.0	1	CAP750374
Pg 13	16	23.0	3.0	7.0	-	2	CAP750124
Pg 13	20	24.0	8.5	7.0	16.8	1	CAP750384
Pg 13	25	27.0	9.5	7.0	16.8	1	CAP750644
Pg 16	16	27.0	3.0	8.0	-	2	CAP750134
Pg 16	20	27.0	7.5	8.0	18.5	1	CAP750394
Pg 16	25	27.0	9.5	8.0	18.8	1	CAP750654
Pg 21	25	32.0	3.5	8.0	-	2	CAP750864
Pg 21	32	34.0	10.5	8.0	24.0	1	CAP750924
Pg 29	32	42.0	4.0	8.5	-	2	CAP750934
Pg 29	40	42.0	10.5	8.5	32.8	1	CAP751194
Pg 36	40	51.0	4.5	8.5	-	2	CAP751294
Pg 36	50	53.0	11.5	8.5	42.5	1	CAP751464
Pg 42	50	58.0	4.5	10.0	-	2	CAP751474
Pg 42	63	67.0	13.0	10.0	49.5	1	CAP751734
Pg 48 DIN	50	64.0	5.0	11.0	-	2	CAP751484
Pg 48 DIN	63	67.0	13.0	11.0	54.5	1	CAP751744

All dimensions in mm.

Technical Specification

Features

- Material: nickel-plated brass/316L stainless steel (316L stainless steel: replace last digit by 9)
- Electrical thread Pg - Standard Guide UTE C 68-311 - DIN 40430
- Adapters, plugs and reducers: IP66, IP68 with fiber or neoprene sealing washer

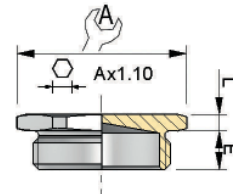
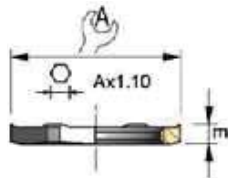
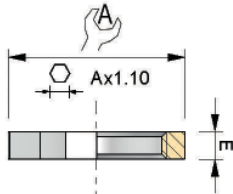

LOCKNUT			CATALOG NUMBER
ISO	A	E	
10	12.0	2.5	CAP221094
12	23.0	3.0	CAP221294
16	29.0	4.0	CAP221694
20	35.0	4.0	CAP222094
25	44.0	4.5	CAP222594
32	60.0	4.8	CAP223294
40	69.0	5.0	CAP224094
50	87.0	6.5	CAP225094
63	103.0	6.5	CAP226394
75	104.0	8.0	CAP227594
90	122.0	8.0	CAP229094
110	132.0	9.0	CAP221104

EARTHING LOCKNUT			CATALOG NUMBER
ISO	A	E	
10	12.0	2.5	CAP229104
12	14.0	3.0	CAP229124
16	18.0	3.0	CAP229164
20	23.0	3.0	CAP229204
25	28.0	3.0	CAP229254
32	36.0	3.5	CAP229324
40	44.0	4.0	CAP229404
50	54.0	5.0	CAP229504
63	70.0	6.0	CAP229634

STOPPING PLUG				CATALOG NUMBER
ISO	A	L	E	
12	15.0	2.5	6.5	CAP197124
16	18.0	2.5	6.5	CAP197164
20	23.0	3.0	6.5	CAP197204
25	28.0	3.0	7.0	CAP197254
32	36.0	3.5	8.0	CAP197324
40	44.0	4.0	8.0	CAP197404
50	54.0	4.5	9.0	CAP197504
63	67.0	5.5	10.0	CAP197634

All dimensions in mm.

All dimensions in mm.

All dimensions in mm.

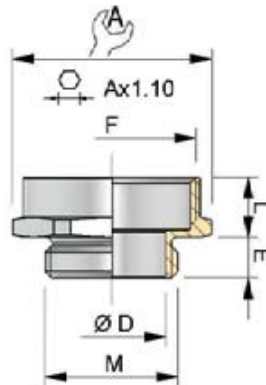
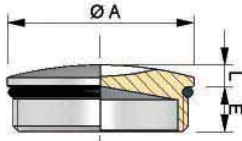

DOME HEAD				CATALOG NUMBER
ISO	A	L	E	
12	14.0	3.0	5.0	CAP196124
16	18.0	3.0	6.0	CAP196164
20	22.0	3.0	6.5	CAP196204
25	27.0	4.0	7.0	CAP196254
32	34.0	4.0	8.0	CAP196324
40	44.0	5.0	8.0	CAP196404
50	54.0	5.5	9.0	CAP196504
63	67.0	6.0	10.0	CAP196634

All dimensions in mm.

ADAPTER						CATALOG NUMBER
ISO M	ISO F	A	L	E	ØD	
12	16	18.0	8.0	5.0	8.8	CAP755334
16	20	22.0	8.0	6.0	12.5	CAP750274
20	25	27.0	9.0	6.0	16.2	CAP750544
25	32	36.0	10.5	7.0	21.0	CAP750814
32	40	42.0	10.5	8.0	28.0	CAP751084
40	50	52.0	11.5	8.0	35.8	CAP751354
50	63	67.0	12.5	9.0	45.8	CAP751624

All dimensions in mm.

Technical Specification

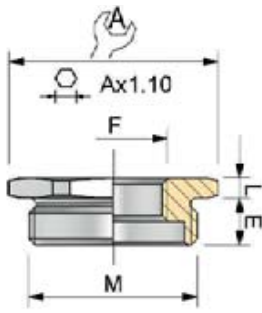

REDUCER					CATALOG NUMBER
ISO M	ISO F	A	L	E	
16	12	18.0	2.5	6.0	CAP755834
20	12	22.0	3.0	6.0	CAP750044
20	16	22.0	3.0	6.0	CAP750024
25	16	28.0	3.0	7.0	CAP750034
25	20	28.0	3.0	7.0	CAP750294
32	16	36.0	3.5	8.0	CAP759104
32	20	36.0	3.5	8.0	CAP750304
32	25	36.0	3.5	8.0	CAP750564
40	16	44.0	4.0	8.0	CAP759164
40	20	44.0	4.0	8.0	CAP759204
40	25	44.0	4.0	8.0	CAP750574
40	32	44.0	4.0	8.0	CAP750834
50	40	54.0	4.5	9.0	CAP751204
63	50	67.0	5.0	10.0	CAP751374

All dimensions in mm.



Capri Industrial Accessories

Features

Features

- Material: nickel-plated brass/316L stainless steel (316L stainless steel: replace last digit by 9)
- Electrical thread Pg - Standard Guide UTE C 68-311 - DIN 40430
- Adapters, plugs and reducers: IP66, IP68 with fiber or neoprene sealing washer

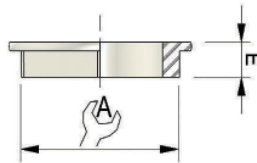
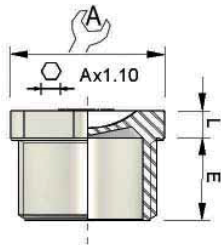

STOPPING PLUG				CATALOG NUMBER
Pg	A	L	E	
Pg 7	15.0	4.0	8.0	CAP190770
Pg 9	19.0	4.5	10.0	CAP190970
Pg 11	22.0	4.5	10.5	CAP191170
Pg 13	24.0	5.0	11.0	CAP191370
Pg 16	27.0	5.0	12.0	CAP191670
Pg 21	32.0	5.5	12.5	CAP192170
Pg 29	40.0	5.5	13.5	CAP192970
Pg 36	54.0	6.0	15.0	CAP193670
Pg 42	59.0	6.5	15.0	CAP193670
N°48 NFC	64.0	6.5	15.0	CAP194870
Pg 48 DIN	64.0	6.5	10.0	CAP194879

All dimensions in mm.

LOCKNUT			CATALOG NUMBER
Pg	A	E	
Pg 7	15.0	4.5	CAP260770
Pg 9	19.0	4.5	CAP260970
Pg 11	22.0	5.0	CAP261170
Pg 13	24.0	5.5	CAP261370
Pg 16	27.0	6.0	CAP261670
Pg 21	32.0	6.5	CAP262170
Pg 29	41.0	7.5	CAP262970
Pg 36	54.0	9.0	CAP263670
Pg 42	60.0	9.0	CAP264270
N°C8 NFC	67.0	9.5	CAP264870
Pg 48 DIN	67.0	9.5	CAP264878

All dimensions in mm.

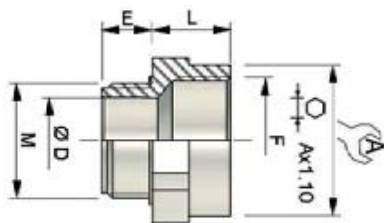
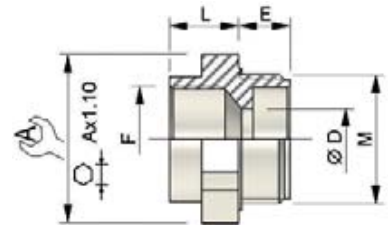

ADAPTER					CATALOG NUMBER
Pg	Pg	A	L	E	
Pg 7	Pg 9	19.0	13.5	6.5	CAP070970
Pg 9	Pg 11	22.0	14.0	7.0	CAP091170
Pg 11	Pg 13	24.0	14.0	8.0	CAP111370
Pg 13	Pg 16	27.0	14.0	9.0	CAP131670
Pg 16	Pg 21	32.0	18.5	9.0	CAP162170
Pg 21	Pg 29	41.0	19.5	10.0	CAP212970
Pg 29	Pg 36	55.0	22.0	12.0	CAP293670
Pg 36	Pg 42	60.0	21.0	14.0	CAP364270
Pg 36	N°48 NFC	65.0	23.5	14.0	CAP364870

All dimensions in mm.

REDUCER					CATALOG NUMBER
Pg M	Pg F	A	L	E	
Pg 9	Pg 7	19.0	11.0	7.0	CAP090770
Pg 11	Pg 7	22.0	10.5	8.0	CAP110770
Pg 11	Pg 9	22.0	12.0	8.0	CAP110970
Pg 13	Pg 9	24.0	11.5	9.0	CAP130970
Pg 13	Pg 11	24.0	12.0	9.0	CAP131170
Pg 16	Pg 9	27.0	11.5	9.0	CAP160970
Pg 16	Pg 11	27.0	12.0	9.0	CAP161170
Pg 16	Pg 13	27.0	13.0	9.0	CAP161370
Pg 21	Pg 11	32.0	11.5	10.0	CAP211170
Pg 21	Pg 13	32.0	12.5	10.0	CAP211370
Pg 21	Pg 16	32.0	12.5	10.0	CAP211670
Pg 29	Pg 13	41.0	12.5	12.0	CAP291370
Pg 29	Pg 16	41.0	12.5	12.0	CAP291670
Pg 29	Pg 21	41.0	16.5	12.0	CAP292170
Pg 36	Pg 29	55.0	16.5	14.0	CAP362970
Pg 42	Pg 36	60.0	20.5	16.0	CAP423670
N°48 NFC	Pg 36	65.0	20.5	16.0	CAP483670

All dimensions in mm.

Features

Features

- Material: nickel-plated brass/316L stainless steel (316L stainless steel: replace last digit by 9)
- Electrical thread Pg - Standard Guide UTE C 68-311 - DIN 40430
- Adapters, plugs and reducers: IP66, IP68 with fiber or neoprene sealing washer



FIBER SEALING WASHER			CATALOG NUMBER
Pg	A	E	
Pg 7	17.0	1.5	CAP240750
Pg 9	21.0	1.5	CAP240950
Pg 11	25.0	1.5	CAP241150
Pg 13	27.0	1.5	CAP241350
Pg 16	31.0	1.5	CAP241650
Pg 21	39.0	1.5	CAP242150
Pg 29	50.0	1.5	CAP242950
Pg 36	64.0	1.5	CAP243650
Pg 42	73.0	1.5	CAP244250
N°48 NFC	79.0	2.0	CAP244850
Pg 48 DIN	79.0	2.0	CAP244850
G2" 1/2	94.0	2.0	CAP245050
G3"	107.0	2.0	CAP246050
G4"	133.0	2.0	CAP248050

All dimensions in mm.

NEOPRENE SEALING WASHER			CATALOG NUMBER
Pg	A	E	
Pg 7	17.0	1.2	CAP240749
Pg 9	21.0	1.2	CAP240949
Pg 11	24.0	1.2	CAP241149
Pg 13	27.0	1.2	CAP241349
Pg 16	30.0	1.2	CAP241649
Pg 21	35.0	1.2	CAP242149
Pg 29	45.0	1.2	CAP242949
Pg 36	60.0	1.2	CAP243649
Pg 42	65.0	1.2	CAP244249
N° 48 NFC	71.0	1.2	CAP244849
Pg 48 DIN	71.0	1.2	CAP244849
G2" 1/2	90.0	1.2	CAP245049
G3"	109.0	1.2	CAP246049
G4"	136.0	1.2	CAP248049

All dimensions in mm.

PVC REDUCE RING NORMANDIX / ECP				CATALOG NUMBER
Pg	Pg	MIN	MAX	
Pg 9	Pg 7	3.5	6.5	CAP240735
Pg 11	Pg 9	5.5	8.7	CAP240935
Pg 13	Pg 9	5.5	8.7	CAP241235
Pg 13	Pg 11	7.0	10.5	CAP241135
Pg 16	Pg 9	5.5	8.7	CAP241535
Pg 16	Pg 11	7.0	10.5	CAP241435
Pg 16	Pg 13	8.0	12.5	CAP241335
Pg 21	Pg 16	10.0	15.0	CAP241635
Pg 29	Pg 21	14.0	19.0	CAP242135
Pg 36	Pg 29	17.5	22.5	CAP242935
Pg 42	Pg 36	22.0	32.5	CAP242635
No 48 NFC	Pg 36	22.0	32.5	CAP244735

All dimensions in mm.

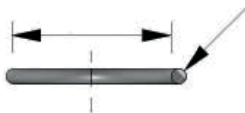

PERBUNAN O-RING			CATALOG NUMBER
Pg	A	E	
Pg 7	10.0	1.3	CAP240746
Pg 9	12.0	1.6	CAP240946
Pg 11	16.0	1.6	CAP241146
Pg 13	16.0	1.6	CAP241346
Pg 16	18.5	1.6	CAP241646
Pg 21	23.5	1.8	CAP242146
Pg 29	32.0	1.6	CAP242946
Pg 36	41.0	1.8	CAP243646
Pg 42	46.0	1.8	CAP244246
N°48 NFC	55.0	2.0	CAP244846
Pg 48 DIN	55.0	2.0	CAP244846

All dimensions in mm.

Technical Specification

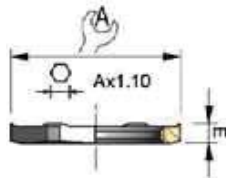
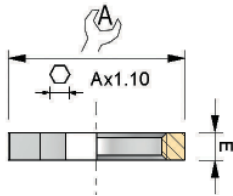

STOPPING PLUG				CATALOG NUMBER
ISO	A	L	E	
12	15.0	4.0	15.0	CAP190126
16	19.0	4.0	15.0	CAP190166
20	23.0	4.0	15.0	CAP190206
25	28.0	5.0	15.0	CAP190256
32	36.0	5.5	15.0	CAP190326
40	44.0	5.5	15.0	CAP190406
50	54.0	6.0	16.0	CAP190506
63	67.0	6.5	17.0	CAP190636

All dimensions in mm.

LOCKNUT			CATALOG NUMBER
ISO	A	E	
12	18.0	4.5	CAP261273
16	22.0	5.0	CAP261673
20	26.0	5.5	CAP262073
25	32.0	6.0	CAP262573
32	41.0	7.0	CAP263273
40	50.0	8.0	CAP264073
50	60.0	8.0	CAP265073
63	75.0	9.0	CAP266373

All dimensions in mm.

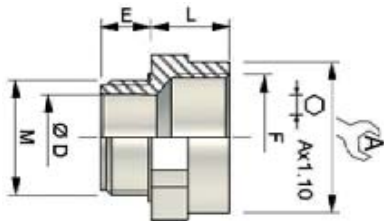
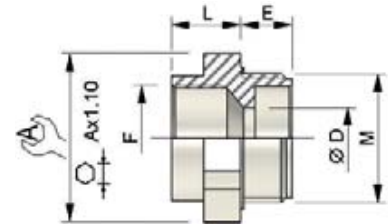

ADAPTER						CATALOG NUMBER
ISO M	ISO F	A	L	E	D	
16	20	24.0	13.0	8.0	11.5	CAP750265
20	25	29.0	15.0	9.0	15.5	CAP750245
25	32	36.0	15.0	11.0	20.0	CAP750705

All dimensions in mm.

REDUCER					CATALOG NUMBER
ISO M	ISO F	A	L	E	
20	12	24.0	4.0	8.0	CAP750015
20	16	24.0	4.5	8.0	CAP750025
25	12	29.0	6.0	8.0	CAP750275
25	16	29.0	6.0	8.0	CAP750285
25	20	29.0	6.0	8.0	CAP750295
32	12	36.0	6.0	8.0	CAP750535
32	16	36.0	6.0	10.0	CAP750545
32	20	36.0	6.0	10.0	CAP750555
32	25	36.0	6.0	10.0	CAP750565
40	16	36.0	6.0	10.0	CAP750805
40	20	46.0	6.0	10.0	CAP750815
40	25	46.0	6.0	10.0	CAP750825
40	32	46.0	6.0	10.0	CAP750835
50	20	55.0	6.0	10.0	CAP751075
50	25	55.0	6.0	12.0	CAP751085
50	32	55.0	6.0	12.0	CAP751095
50	40	55.0	6.0	12.0	CAP751105
63	25	68.0	6.0	12.0	CAP751345
63	32	68.0	6.0	12.0	CAP751355
63	40	68.0	6.0	12.0	CAP751365
63	50	68.0	6.0	12.0	CAP751375

All dimensions in mm.

Technical Specification

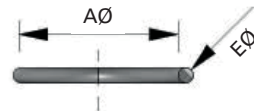
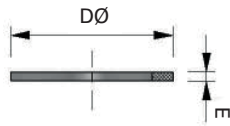
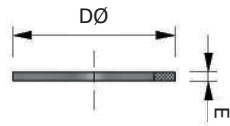

FIBER SEALING WASHER			CATALOG NUMBER
ISO	D	E	
10	15.0	1.2	CAP221045
12	18.0	1.2	CAP221245
16	22.0	1.2	CAP221645
20	27.0	1.2	CAP222045
25	35.0	1.5	CAP222545
32	43.0	1.5	CAP223245
40	55.0	1.5	CAP224045
50	69.0	1.5	CAP225045
63	82.0	2.0	CAP226345
75	94.0	2.0	CAP227545
90	110.0	2.0	CAP229045
110	130.0	2.0	CAP221145

All dimensions in mm.

NEOPRENE SEALING WASHER			CATALOG NUMBER
ISO	D	E	
10	15.0	1.2	CAP221049
12	18.0	1.2	CAP221249
16	18.0	1.2	CAP221649
20	22.0	1.2	CAP222049
25	24.0	1.5	CAP222549
32	30.0	1.5	CAP223249
40	42.0	1.5	CAP224049
50	52.0	1.5	CAP225049
63	63.0	2.0	CAP226349
75	90.0	2.0	CAP227549
90	106.0	2.0	CAP229049
110	126.0	2.0	CAP221149

All dimensions in mm.

PERBUNAN O-RING			CATALOG NUMBER
ISO	A	E	
12	10.0	1.8	CAP241244
16	12.5	1.8	CAP241644
20	17.0	1.8	CAP242044
25	22.0	1.8	CAP242544
32	28.0	1.6	CAP243244
40	37.0	1.8	CAP244044
50	46.0	1.8	CAP245044
63	57.0	1.8	CAP246344

All dimensions in mm.

Technical Information



Cable Glands - Installation Guide

Fixing - Blank Hole

ISO

Cable Gland

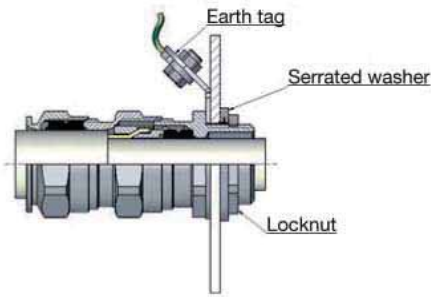

Cable Gland with an Accessory

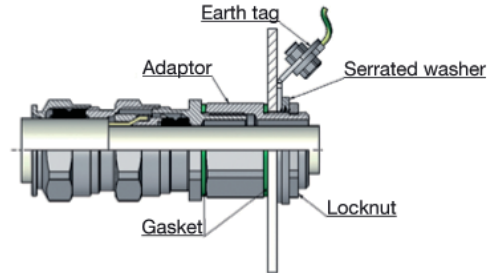
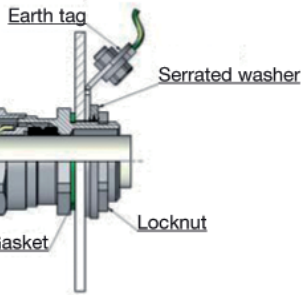
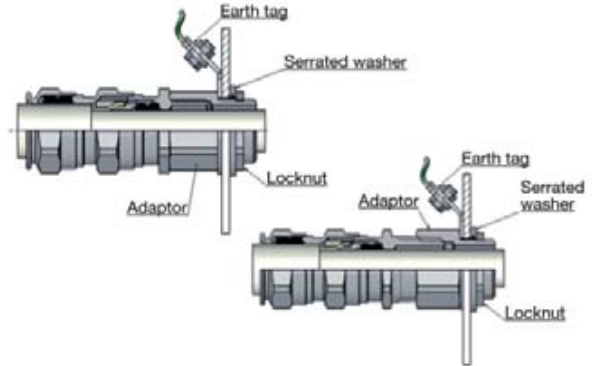

NPT

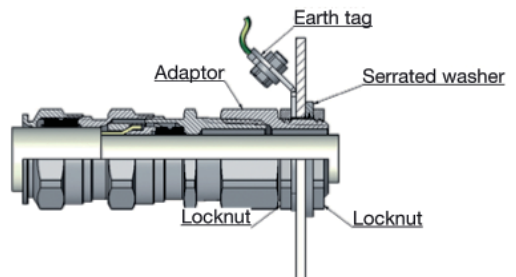
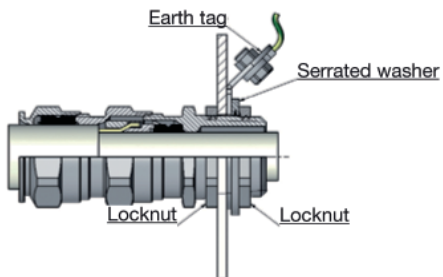
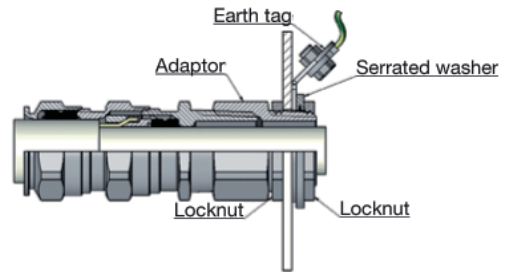
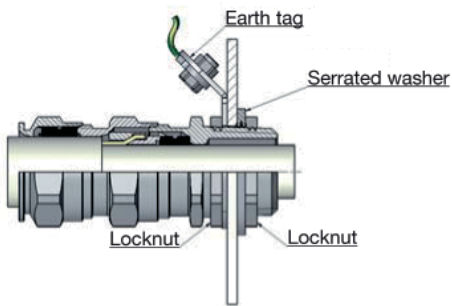

Cable Glands - Installation Guide

Fixing - Threaded Hole

Cable Gland

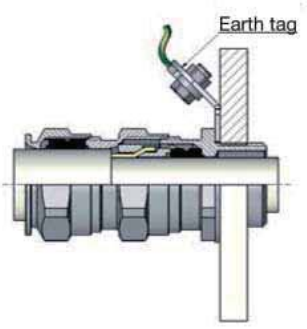

Cable Gland with an Accessory

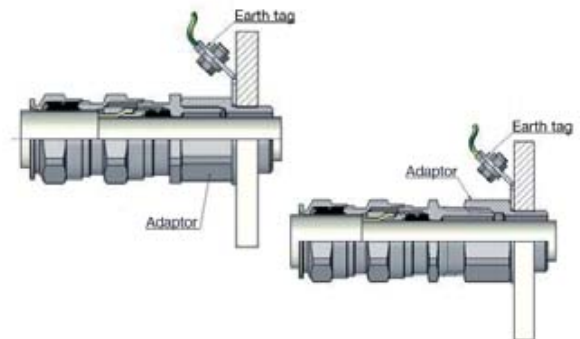

ISO

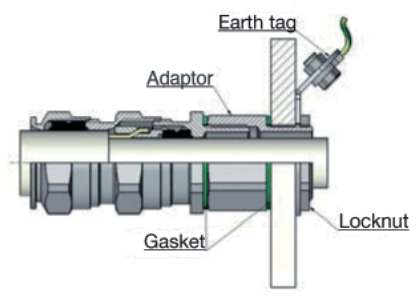
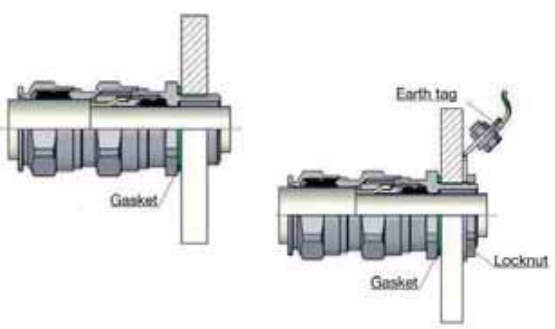

NPT

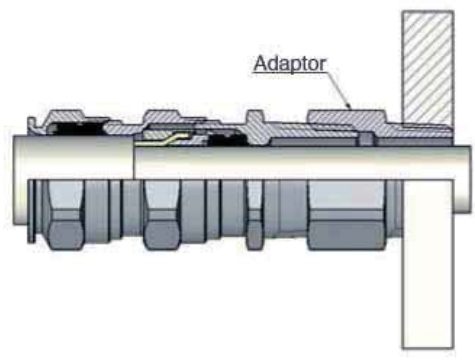
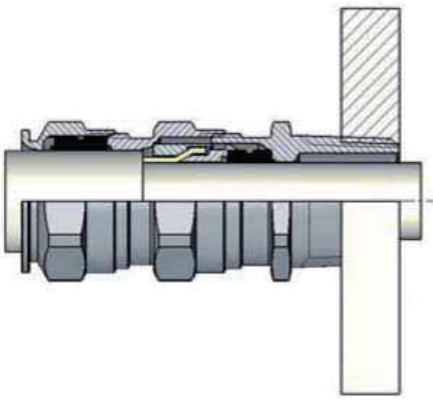

Capri Cable Gland Certifications

	LOCATIONS		HAZARDOUS LOCATIONS	
	Labs:	ATEX / INERIS	IECEx / INERIS	CEPEL
ADE Ex Certification	Certificate No.:	INERIS12ATEX0032X:	IECEx INE12.0025X	05.0558X for 1F2, 1F2 A, 1FC 05.0559X for 4F, 5F, 6F, 6FC
<p>ADE 1F2 n°3 to 17 & 1F2 A (Anchorage) 1F2 DS Cable outer Ø 2.75 to 104 mm Fixing thread metric 10 to 110 Fixing thread NPT 1/8" to 4"</p> <p>ADE 1FC n°4 to 16 Cable outer Ø 4 to 93 mm Fixing thread metric 16 to 110 Fixing thread NPT 3/8" to 4"</p> <p>ADE 4F & 5F n°4 to 17 Cable outer Ø 4.5 to 104 mm Fixing thread metric 10 to 110 Fixing thread NPT 1/8" to 4"</p> <p>ADE 6F n°5 to 11 Cable outer Ø 6 to 48 mm Fixing thread metric 16 to 63 Fixing thread NPT 3/8" to 2"</p> <p>ADE 6FC n°5 to 17 Cable outer Ø 6 to 104 mm Fixing thread metric 16 to 110 Fixing thread NPT 3/8" to 4"</p>	Standards:	EN 60079-0 : 2012 EN 60079-1 : 2007 EN 60079-7 : 2007 EN 60079-31 : 2009 IEC 60079-0 : 2011 IEC 60079-1 : 2007 IEC 60079-7 : 2006 IEC 60079-31 : 2008	IEC 60079-0 : 2011 IEC 60079-1 : 2007 IEC 60079-7 : 2006 IEC 60079-15 : 2010 IEC 60079-31 : 2008	ABNT NBR IEC 60079-0:2008 ABNT NBR IEC 60079-1:2009 ABNT NBR IEC 60079-7:2008 ABNT NBR IEC 60529:2009 IEC 60079-15:2010 IEC 60079-31:2008
	Protections: Special note: Not Gr. I for: a) Thread smaller M20 & NPT 1/2" b) ADE 1F2 & 6F	II2GD / Ex db IIC / Ex eb IIC / Ex tb IIIC II3G Ex nRc IIC IM2 Ex db I Ex eb I	Ex db IIC / Ex eb IIC Ex nRc IIC / Ex tb IIIC Ex db I Ex eb I	Ex db IIC / Ex eb IIC Ex nRc IIC / Ex tb IIIC Ex db I Ex eb I
	Ex Sealing Types & Service Temperatures:	ADE 1F2, 1F2 A, 1F2 DS, 4F & 5F: Black neoprene ring: -30°C to +80°C Red silicone ring: -60°C to +140°C ADE 6F: red silicone ring: -60°C to +80°C ADE 1FC & 6FC: TSC compound: -60° to +80°C		
	IP:	IP66, IP67, IP68 (30m/7days)		
	Classifications:	Zones 1 and 2, Groups I, IIA, IIB and IIC; "d", "e", "i", "m", "n", "o", "p", "q" Zones 21 and 22, Groups IIIA, IIIB and IIIC; "i", "m", "p", "t"		
	Cable Types:	Non-armoured cable with ADE 1F2, 1F2 A, 1F2 DS & 1FC Armoured or braided cable with ADE 4F, 5F, 6F & 6FC		
	ADE UL Certification	Certificate No.:	cULus E310130	cULus Marine E314047
All ADE	Standards:	UL2225 3rd Ed. & UL514B 5th Ed. CAN/CSA E60079-0:07 & CAN/CSA E60079-7:03	UL2225 3rd Ed. & UL514B 5th Ed & Sub-part 111.60 of the United States Coast Guard Electrical Engineering Regulations, Sub-chapter J (Title 46 of Federal Regulations, Parts 110 to 113 inclusive) CAN/CSA E60079-0:07 & CAN/CSA E60079-7:03 & Ships Electrical Standards, TP 127E, Section 26, Sub-sections 8 and 9	
	IP:	IP68	IP68	
<p>ADE 1F2 & 1F2 A, 1F2 DS n°3 to 17 Cable outer Ø 2.75 to 104 mm Fixing thread metric 10 to 110 Fixing thread NPT 1/8" to 4"</p> <p>ADE 4F, 5F n°4 to 17 Cable outer Ø 4.5 to 104 mm Fixing thread metric 10 to 110 Fixing thread NPT 1/8" to 4"</p> <p>ADE 6F n°5 to 11 Cable outer Ø 6 to 48 mm Fixing thread metric 16 to 63 Fixing thread NPT 3/8" to 2"</p>	Classifications:	a) Class I, Zone 2, AEx e II, Ex e II b) Class I, Zone 1, AEx ell for ADE-1F2, -1F2 A & -1F2 DS n°3 to n°8, thread sizes NPT 1/2 to 1-1/4 or M20 to M40, with TC-ER-HL unarmoured cable up to diameter 1 inch.	ADE 1F2: Class I, Zone 2, AEx e II, Ex e I ADE 4F & 6F: Class I, Zone 1, AEx e II, Ex e II	
	Ex Sealing Type & Service Temperature:	ADE-1F2, 1F2 A, 1F2 DS, 4F & 5F: Black neoprene ring: -30 to +80°C Red silicon ring : -60 to +140°C ADE-6F: Red silicon ring : -60 to +80°C	ADE 1F2, 1F2 A, 1F2 DS & 4F, 5F: Black neoprene ring: -30°C to +80°C Red silicone ring: -60°C to +140°C ADE 6F: Red silicone ring: -30°C to +80°C	
	Cable Type:	ADE-1F2, 1F2 A & 1F2 DS: a) ITC, MV, PLTC, TC Unarmoured cable b) TC-ER-HL unarmoured cable for Class I, Zone 1, AEx ell ADE-4F, 5F & 6F: ITC, MV, PLTC, TC Armoured cable ITC (Instrumentation-Tray-Cable), MV (Medium Voltage cable), PLTC (Power-Limited-Tray-Cable) and TC (Tray Cable).	ADE 1F2 & 1F2 A, 1F2 DS: Non-armoured marine shipboard cable ADE 4F, 5F & 6F Armoured marine shipboard cable	
<p>ADE 1FC n°4 to 16 Cable outer Ø 4 to 93 mm Fixing thread metric 20 to M 110 Fixing thread NPT 1/2" to 4"</p> <p>ADE 6FC n°5 to 17 Cable outer Ø 6 to 104 mm Fixing thread metric 20 to 110 Fixing thread NPT 1/2" to 4"</p>	Classifications:	Class I, Zone 2, AEx de II, Ex de II		
	Sealing & Temperature:	TSC compound: -60°C to +80°C		
	Cable Type:	ADE 1FC: ITC, MV, PLTC, TC non-armoured cable ADE 6FC: ITC, MV, PLTC, TC armoured cable		

Per the NEC 501.5 Zone Equipment: Equipment listed and marked in accordance with 505.9(C)(2) for use in Zone 0, 1, or 2 locations shall be permitted in Class I, Division 2 locations for the same gas and with a suitable temperature class. Equipment listed and marked in accordance with 505.9(C)(2) for use in Zone 0 locations shall be permitted in Class I, Division 1 or Division 2 locations for the same gas and with a suitable temperature class. According that, all above (1) ADE cable glands can be used in a Div 2 installation provided that the enclosure does not contain arcing or sparking components.

HAZARDOUS LOCATIONS		HAZARDOUS LOCATIONS FOR SHIPPING APPLICATIONS			DELUGE
NANIO CCV	NEPSI	DNV	ABS	LLOYDS	Dcns
TC RU C-FR.Г505.B.00858:	GYJ13.1082X	E-13811	14-HS1274083-2-PDA	11/00072	DTS01 20121029
P MЭК 60079-0:2011 TR CU 012/2011 ГОСТ Р МЭК 60079-0:2011 ГОСТ Р МЭК 60079-1:2011 ГОСТ Р МЭК60079-7:2012 ГОСТ Р МЭК60079-15:2010 ГОСТ Р МЭК 60079-31:2010	GB3836.1-2010 GB3836.2-2010 GB3836.3-2010 GB12476.1-2000	EN 50262/1998 EN 60079-0 : 2009 EN 60079-1 : 2007 EN 60079-7 : 2007 EN 60079-31 : 2009 IEC 62444:2010 IEC 60079-0 : 2011 IEC 60079-1 : 2007 IEC 60079-7 : 2006 IEC 60079-31 : 2008	ABS: 2013 Steel Vessels Rules 1-1-4/7.7, 1-1-A3, 4-8-3/1.7, 4-8-3/13 UL 2225 2nd Ed. IEC 60079-0:2011 IEC 60079-1:2007 IEC 60079-7:2006 IEC 60079-15:2010 IEC 60079-31:2008 IEC61241-1 :2004	IEC 60079-0:2011 IEC 60079-1:2007 IEC 60079-7:2006 IEC 60079-15:2010 IEC 60079-31:2008 IEC61241-1 :2004 UL 2225 2nd Ed. UL 514B 5th Ed. CSA E 60079-0 :2007 CSA E 60079-7 :2003	DTS01 :1991
Ex d IIC Gb X / 1Ex e IIC Gb X Ex nR IIC Gc X Ex tb IIIC Db IP6X PB Ex db I X / PB Ex eb I X	Ex d IIC Gb / Ex e IIC Gb Ex d I Mb / Ex e I Mb DIP A21 IP66/IP68	Ex db IIC / Ex eb IIC Ex nRc IIC / Ex tb IIIC Ex db I Ex eb I	<p>- For Zones system, see at left - For Class system, see UL below</p>		
<p>ADE 1F2, 1F2 A, 1F2 DS, 4F & 5F: Black neoprene ring: -30°C to +80°C Red silicone ring: -60°C to +140°C ADE 6F: red silicone ring: -60°C to +80°C ADE 1FC & 6FC: TSC compound: -60°C to +80°C</p>					
IP66, IP67, IP68 (30m/7days)					
<p>Zones 1 and 2, Groups I, IIA, IIB and IIC; "d", "e", "i", "m", "n", "o", "p", "q" Zones 21 and 22, Groups IIIA, IIIB and IIIC; "i", "m", "p", "t"</p>					
<p>Non-armoured cable with ADE 1F2, 1F2 A, 1F2 DS & 1FC Armoured or braided cable with ADE 4F, 5F, 6F & 6FC</p>					

UL Marine E324850
UL2225 3rd Ed. & UL514B 5th Ed. & Sub-part 111.60 of the United States Coast Guard Electrical Engineering Regulations, Sub-chapter J (Title 46 of Federal Regulations, Parts 110 to 113 inclusive)
IP68
ADE 1FC: Class I, Division 2, Groups A, B, C, D ADE 6FC: Class I, Division 1, Groups A, B, C, D
TSC compound: -20°C to +40°C
ADE 1FC: non-armoured marine shipboard cable ADE 6FC: armoured marine shipboard cable

Certificate No.:	ATEX / INERIS	IECEx / INERIS	
	INERIS13ATEX0008X	IECEx INE13.0003X	
NEWCAP	Standards:	<p>EN 60079-0 : 2009 EN 60079-7 : 2007 EN 60079-31 : 2009 IEC 60079-0 : 2011 IEC 60079-7 : 2006 IEC 60079-31 : 2008</p>	<p>IEC 60079-0 : 2011 IEC 60079-7 : 2006 IEC 60079-15 : 2010 IEC 60079-31 : 2008</p>
	Protections:	<p>II2GD Ex eb IIC Ex tb IIIC II3G Ex nRc IIC</p>	<p>Ex eb IIC Ex nRc IIC Ex tb IIIC</p>
	IP:	IP66, IP67, IP68	
	Classification:	<p>Zones 1 and 2, Groups IIA, IIB and IIC; "e", "i", "m", "n", "o", "p", "q" Zones 21 and 22, Groups IIIA, IIIB and IIIC; "i", "m", "p", "t"</p>	
	Temperature:	-20°C to +80°C	
EXACAP	Certificate N°:	<p>PTB 99 ATEX 3101 X (M12 - M16 only) PTB 99 ATEX 3128 X (M20 - M63 only)</p>	IECEx PTB 05.0004X
	Standards:	<p>EN 60079-0:2004/2006 EN 60079-7:2003/2007 EN 61241-0 : 2006 EN 61241-1 : 2004</p>	<p>IEC 60079-0 : 2000 IEC 60079-7 : 2001</p>
	IP:	IP66	IP66
	Protections:	<p>II2G Ex e II II2D Ex tb A21</p>	Ex eb II
	Temperature:	-25°C to +70°C	-55°C to +70°C

Capri ADE Ex Markings

ADE 1F2		CCH-CAPRI ADE-1F2 n°8 M32 SL Ex e II AEx e II CL.I Zn.2 SL Ex e II AEx e II CL.I Zn.2 CE 0081 I12GD I13G INERIS12ATEX0032X IECEX INE 12.0025X CEPEL 05.0558X Ex db/eb IIC Ex tb IIIC IP66 Ex nRc IIC Cable Ext.Ø 18-27.5
ADE 1F2A		CCH-CAPRI ADE-1F2 n°8 M32 SL Ex e II AEx e II CL.I Zn.2 SL Ex e II AEx e II CL.I Zn.2 CE 0081 I12GD I13G INERIS12ATEX0032X IECEX INE 12.0025X CEPEL 05.0558X Ex db/eb IIC Ex tb IIIC IP66 Ex nRc IIC Cable Ext.Ø 18-27.5 Mining marking, depending Thread & Size N° and never for Aluminum version: CCH-CAPRI ADE (Ex) IM2 Ex db Ex eb CCH-CAPRI ADE (Ex) IM2 Ex db Ex eb
ADE 1F2 DS		CCH-CAPRI ADE-1F2 n°8 M32 CE 0081 20 12 I12GD INERIS12ATEX0032X IECEX INE 12.0025X Ex db IIC Ex eb IIC Ex tb IIIC IP66 Marking for Non Mining models, depending on Thread & Size N° and never for Aluminum version: CCH-CAPRI ADE-1F2 DS n°xx (Ex) Marking for Mining models, depending on Thread & Size N° and never for Aluminum version: CCH-CAPRI ADE-1F2 DS n°xx (Ex) IM2 Ex db Ex eb
ADE 1FC		M32x1.5 CCH-CAPRI ADE-1FC n°7 SL CL.I Div.2 SL Ex e II AEx e II CL.I Zn.2 SL Ex e II AEx e II CL.I Zn.2 CE 0081 I12GD I13G INERIS12ATEX0032X IECEX INE 12.0025X CEPEL 05.0558X Ex db/eb IIC Ex tb IIIC IP66 Ex nRc IIC Cable Ext.Ø 12-21 Marking for Mining models, Size N°11 to 16, and never for Aluminum version: CCH-CAPRI ADE (Ex) IM2 Ex db Ex eb CCH-CAPRI ADE (Ex) IM2 Ex db Ex eb
ADE 4F		M32x1.5 CCH-CAPRI ADE-4F n°8 SL Ex e II AEx e II CL.I Zn.1 SL Ex e II AEx e II CL.I Zn.2 SL Ex e II AEx e II CL.I Zn.2 CE 0081 I12GD I13G INERIS12ATEX0032X IECEX INE 12.0025X CEPEL 05.0559X Ex db/eb IIC Ex tb IIIC IP66 Ex nRc IIC Cable Ext.Ø 18-27.5 Marking for Mining models, depending on Thread & Size N° and never for Aluminum version: CCH-CAPRI ADE (Ex) IM2 Ex db Ex eb CCH-CAPRI ADE (Ex) IM2 Ex db Ex eb
ADE 5F		M32x1.5 CCH-CAPRI ADE-5F n°8 SL Ex e II AEx e II CL.I Zn.1 SL Ex e II AEx e II CL.I Zn.2 SL Ex e II AEx e II CL.I Zn.2 CE 0081 I12GD I13G INERIS12ATEX0032X IECEX INE 12.0025X CEPEL 05.0559X Ex db/eb IIC Ex tb IIIC IP66 Ex nRc IIC Cable Ext.Ø 18-27.5 Marking for Mining models, depending on Thread & Size N° and never for Aluminum version: CCH-CAPRI ADE (Ex) IM2 Ex db Ex eb CCH-CAPRI ADE (Ex) IM2 Ex db Ex eb
ADE 6F		M32x1.5 CCH-CAPRI ADE-6F n°8 SL Ex e II AEx e II CL.I Zn.1 SL Ex e II AEx e II CL.I Zn.2 SL Ex e II AEx e II CL.I Zn.2 CE 0081 I12GD I13G INERIS12ATEX0032X IECEX INE 12.0025X CEPEL 05.0559X Ex db/eb IIC Ex tb IIIC IP66 Ex nRc IIC Cable Ext.Ø 18-27.5
ADE 6FC		M32x1.5 CCH-CAPRI ADE-6FC n°8 SL CL.I Div.1 SL Ex e II AEx e II CL.I Zn.2 SL Ex e II AEx e II CL.I Zn.2 CE 0081 I12GD I13G INERIS12ATEX0032X IECEX INE 12.0025X CEPEL 05.0559X Ex db/eb IIC Ex tb IIIC IP66 Ex nRc IIC Cable Ext.Ø 16-27.5 Marking for Mining models, Size N°11 to 17, and never for Aluminum version: CCH-CAPRI ADE (Ex) IM2 Ex db Ex eb CCH-CAPRI ADE (Ex) IM2 Ex db Ex eb

Details of the Main Ex Marking (Example on ADE 1F2):

CCH-CAPRI ADE 1F2 n°10 M50	SL Ex e II AEx e II Cl. I, Zn.2 if c...us marked	SL Ex e II AEx e II Cl.I, Zn. 2 if c...us marked	CE 20XX 0081 I12GD I13G	INERIS12ATEX0032X IECEX INE 12.0025X CEPEL 05.0558X	Ex db / eb IIC Ex tb IIIC IP66 Ex nRc IIC	Cable Ext. Ø 29-41
Name of the manufacturer Product type identification Cable size and thread type & size	UL marine certification valid for Canada & U.S. if c...us marked	UL certification valid for Canada & U.S. if c...us marked	ATEX directive marking, including the year of production	Certificate No.: ATEX IECEX CEPEL/INMETRO	New EPL specific ATEX & IECEX marking	Cable external diameter

Crouse-Hinds Cable Gland Certifications

US Cable Gland Certification (January 2014)					
UL Certification	Certification No.	cULus E122485	UL E36379	UL E22133	LR13046
	Standards:	UL2225 3rd Ed. & UL514B	UL514B	UL514B	CSA C22.2 No. 174
TMCX II Cable outer Ø 0.49 to 1.39 inches Fixing thread NPT: 1/2" to 1 1/4"	Classification:	TMCX II: cULus Listed Class I, Div. 1, Groups A, B, C, D; Class II, Groups E, F, G; Class III			
	Sealing Type, Service Temperature & Environmental:	TMCX II: TSC compound, Chico LiquidSeal: -40°C to +60°C; NEMA 4, 6P			
	Cable Type:	TMCX II: MC-HL (metal-clad for hazardous locations), MC (metal-clad), TECK, TC (tray cable)			
TMCX Cable outer Ø 0.49 to 4.28 inches Fixing thread NPT: 1/2" to 4"	Classification:	TMCX: UL Listed Class I, Div. 1, Groups A, B, C, D; Class II, Groups E, F, G; Class III			TMCX: CSA Listed Class I, Div. 1, Groups A, B, C, D; Class II, Groups E, F, G; Class III
	Sealing Type, Service Temperature & Environmental:	TMCX: TSC compound: -25°C to +40°C: NEMA 4X			TMCX : TSC compound: -25°C to +40°C
	Cable Type:	TMCX: MC-HL, MC, TECK			TMCX: MC-HL, MC, TECK
TMC Cable outer Ø 0.49 to 4.28 inches Fixing thread NPT: 1/2" to 4"	Classification:		UL Listed Ordinary Locations		
	Sealing Type, Service Temperature & Environmental:		Neoprene seal: -25°C to +60°C: NEMA 4		
	Cable Type:		MC		
TECK Cable outer Ø 0.52 to 4.34 inches Fixing thread NPT: 1/2" to 4"	Classification:				CSA Certified Class II, Groups E, F, G; Class III
	Sealing Type, Service Temperature & Environmental:				Neoprene seal: -25°C to +60°C: Type 4 and IP56
	Cable type:				TECK
CGB Cable outer Ø 0.12 to 2.50 inches Fixing thread NPT: 3/8" to 3"	Classification:			cULus Listed Ordinary Locations	
	Sealing Type, Service Temperature & Environmental:			Neoprene seal: -25°C to +40°C	
	Cable Type:			Non-armoured	

Cable Types and Wiring Methods

		CABLE TYPES															
		MC	MC-HL	TC	TC ER HL	MI	TECK	TECK-HL	PLTC	MV	ITC	ITC-HL	SWA	STA	SWB	Braided marine shipboard	Non-armoured
IEC	Zone 1			•				•					•	•	•	•	•
	Zone 2			•				•					•	•	•	•	•
NORTH AMERICA	Div. 1		•		•***	•	•*	•*				•				•**	
	Div. 2	•	•	•	•	•	•	•	•	•	•	•	•			•	•
	Zone 1		•		•***	•	•*	•*				•				•**	
	Zone 2	•	•	•	•	•	•	•	•	•	•	•	•			•	•

All wiring for Div. 1 is suitable for Div. 2.

All wiring for Zone 1 is suitable for Zone 2.

* Canada only.

** Armoured and sheathed marine shipboard cable can be used in Class I, Division 1 locations offshore as mentioned in API RP14F.

For Canada: Not Class I. For areas under jurisdiction of Transport Canada's Electrical Requirements per TP127E. For further details on Canada specific requirements, please contact your local Eaton representative.

*** Approved in Class 1 Division 1 up to 1" cable OD







IEC Wiring Methods

Although there are no IEC construction standards for the cables intended for use in flammable atmospheres, according to IEC 60079-14:2002, 10.4.2(b), if a cable gland with an elastomeric flameproof sealing ring is to be used, when connecting cables to Ex d equipment enclosures, the cable should be: substantially compact and circular, have an extruded bedding (without gaps) and have fillers, if any are used, which are non-hygroscopic.

NEC/CEC Wiring Methods

As shown in the table above, the only cables that are permitted for use in Class I, Div. 1 are those that are mechanically protected by armour. The three protection techniques approved for Class I, Div. 1 locations are "intrinsically safe," "purge and pressurized" and "explosionproof." When using the explosionproof protection technique, the cable must be sealed at the point of entry with an approved sealing device.

Armoured Cable

	STEEL WIRED ARMoured
	STEEL BRAID ARMoured
	STEEL TAPE ARMoured
	TYPE P CABLE
	METAL-CLAD
	TECK

ADE 4F*

ADE 5F*

ADE 6F

ADE 6FC

* Lead sheathed on ADE 4F & ADE 5F only.

TMCX TMCX II TMC

TMCX TMCX II TECK

Non-armoured Cable

	NON-ARMoured
	TRAY / TYPE P

ADE 1F2 ADE 1F2 DS ADE 1FC

TMCX TMC ADE 1F2 DS

Selection of Cable Glands - Technical References

References to IEC Standards:

60079-14/Ed.5: Explosive Atmospheres – Part 14: Electrical Installations Design, Selection and Erection

60079-0/Ed.6: Explosive Atmospheres – Part 0: Equipment – General Requirements

Extract from IEC 60079-14/Ed.5:

10.2 Selection of Cable Glands

Cable glands shall be in accordance with IEC 60079-0 and shall be selected to maintain the requirements of the protection technique according to the table below.

PROTECTION TECHNIQUE FOR THE EQUIPMENT	GLANDS, ADAPTERS AND BLANKING ELEMENT PROTECTION TECHNIQUE			
	Ex 'd' - see 10.6	EX 'e' - see 10.4	Ex 'n' - see 10.4	Ex 't' - see 10.7
Ex 'd'	X			
Ex 'e'	X	X		
Ex 'i' and Ex 'nL' - Group II ^a	X	X	X see 16.5	
Ex 'i' - Group III ^a				X see 16.5
Ex 'm'	Ex 'm' would not normally be applied to wiring connections. The protection technique for connections shall suit the wiring system used.			
Ex 'n' except Ex 'nL' For Ex "nR" see also 10.8	X	X	X	
Ex 'o'	Ex 'o' would not normally be applied to wiring connections. The protection technique for connections shall suit the wiring system used.			
Ex 'p', all types	X	X	X ^b	
Ex 'pD'				X
Ex 'q'	Ex 'q' would not normally be applied to wiring connections. The protection technique for connections shall suit the wiring system used.			
Ex 's'	Only as allowed by the conditions of the certificate.			
Ex 't'				X

X Denotes permitted use.

a) If only one intrinsically safe circuit is applied, then there are no specified requirements for cable glands.

b) Only permitted for Gc installations.

To meet the ingress protection requirement, it may also be necessary to seal between the cable glands, adapters and blanking elements and the enclosure (for example, by means of a sealing washer or thread sealant).

Note 2: In order to meet the minimum requirement of IP54, threaded cable entry devices into threaded cable entry plates or enclosures of 6mm or greater thickness need no additional sealing between the cable entry device and the entry plate or enclosure providing the axis of the cable entry device is perpendicular to the external surface of the cable entry plate or enclosure.

Selection of Cable Glands - Technical References

10.3 Connections of Cables to Equipment

Cable glands shall be installed in a manner that after installation they are only capable of being released or dismantled by means of a tool.

If additional clamping is required to prevent pulling and twisting of the cable transmitting the forces to the conductor terminations inside the enclosure, a clamp shall be provided, as close as practicable to the gland along the cable.

Capri ADE Gland with Clamping Module

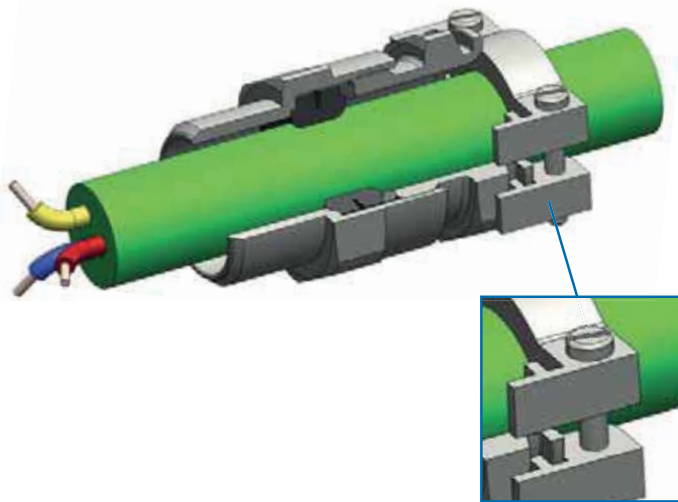

NOTE 1 Cable clamps within 300mm of the end of the cable gland are preferred.

Cables shall be routed straight from the cable gland to avoid lateral tension that may compromise the seal around the cable. Where cable glands, blanking elements and adapters with tapered threads are used in enclosures having gland plates with unthreaded entries, care shall be taken to use appropriate fittings to maintain the enclosure integrity.

NOTE 2 Tapered threads include NPT threads.

When braided or armoured cables have been terminated within the cable gland, the body components that are intended to retain and secure the cable braid or armour should not be able to be released manually or opened by hand without the use of a tool.

The connection of cables to the electrical equipment shall be effected by means of cable glands appropriate to the type of cable used and shall maintain the explosion protection integrity of the relevant type of protection.

Where the threaded entry or hole size is different to that of the cable gland, a threaded adapter complying with Table 10 shall be fitted.

10.6 Additional Requirements for Type of Protection 'd' – Flameproof Enclosures

10.6.1 General

Where cables enter into flameproof equipment via flameproof bushings through the wall of the enclosure which are part of the equipment (indirect entry), the parts of the bushings outside the flameproof enclosure shall be protected in accordance with one of the types of protection listed in IEC 60079-0. For example, the exposed parts of the bushings are within a terminal compartment which may either be another flameproof enclosure or will be protected by type of protection "e".

If an Ex 'd' gland clamping by the sealing ring (compression) is used with braided or armoured cable, it shall be of the type where the braid or armour is terminated in the gland and compression takes place on the inner cable sheath. For fine braided cable, where the braid is less than 0.15mm diameter and has coverage of at least 70% compression only on the outer sheath is accepted.

NOTE 1 Propagation of flame may occur through the interstices between the strands of standard stranded conductors, or between individual cores of a cable. Special cable construction can be employed as means of reducing and preventing flame propagation. Examples include compacted strands, sealing of the individual strands, and extruded bedding. Further information is given in Annex E.

Selection of Cable Glands - Technical References

Flameproof cable glands, adapters or blanking elements, having parallel threads may be fitted with a sealing washer between the entry device and the flameproof enclosure provided that, after the washer has been fitted, the applicable thread engagement is still achieved. Thread engagement shall be at least five full threads. Suitable grease may be used, provided it is non-setting, non-metallic and non-combustible and any earthing between the two is maintained.

Where taper threads are used, the connection shall be made wrench-tight.

The addition of holes or alteration to thread form is only permitted when in compliance with the certification documents and completed by the manufacturer or certified workshops. Where the threaded entry or hole size is different to that of the cable gland, a flameproof threaded adapter complying with IEC 60079-1 shall be fitted which complies with thread engagement requirements detailed above. Unused cable entries shall be sealed with a flameproof blanking element complying with IEC 60079-1, which shall be fitted directly to the hole (no threaded adapter shall be used), and shall comply with thread engagement requirements detailed above and shall be secured against loosening.

NOTE 2 Non-threaded cable glands can be used if certified with the complete equipment or if certified as equipment.

10.6.2 Selection of Cable Glands

The cable entry system shall comply with one of the following:

- a)** Cable glands sealed with setting compound (barrier cable glands) in compliance with IEC 60079-1 and certified as equipment;
- b)** Cables and glands meeting all of the following:
 - cable glands comply with IEC 60079-1 and are certified as equipment
 - cables used comply with 9.3.2(a)
 - the connected cable is at least 3 m in length;
- c)** Indirect cable entry using combination of flameproof enclosure with a bushing and increased safety terminal box;
- d)** Mineral-insulated metal sheathed cable with or without plastic outer covering with appropriate flameproof cable gland complying with IEC 60079-1;
- e)** Flameproof sealing device (for example, a sealing chamber) specified in the equipment documentation or complying with IEC 60079-1 and employing a cable gland appropriate to the cables used. The sealing device shall incorporate compound or other appropriate seals which permit stopping around individual cores. The sealing device shall be fitted at the point of entry of cables to the equipment.

NOTE 1 The minimum length of cable is to minimize the potential for flame transmission through the cable (see also Annex E).

NOTE 2 If the cable gland and actual cable are certified as a part of the equipment (enclosures), then compliance to 10.6.2 is not necessary.

Extract from IEC 60079-0/Ed.6:

Annex A - Supplementary Requirements for Cable Glands

A.2.3 Clamping

A.2.3.1 General

Cable glands shall provide clamping of the cable in order to prevent pulling or twisting applied to it from being transmitted to the connections. Such clamping can be provided by a clamping device, sealing ring or filling compound. Whichever clamping arrangement is used, it shall be capable of meeting the relevant type tests in Clause A.3.

A.2.3.2 Group II or III Cable Glands

Cable glands for Group II or III equipment, without a clamping device, shall also be accepted as complying with this annex if they are capable of passing the clamping tests with values reduced to 25% of those required in Clause A.3. The descriptive documents shall then state that such cable glands may not provide sufficient clamping and that the user shall provide additional clamping of the cable to ensure that pulling and twisting is not transmitted to the terminations. Such cable glands shall be marked with the symbol "X" to indicate this specific condition of use according to item e) of 29.3.

The author thanks the International Electrotechnical Commission (IEC) for permission to reproduce Information from its International Standard IEC 60079-14 Ed.5.0 (2013). All such extracts are copyright of IEC, Geneva, Switzerland. All rights reserved. Further information on the IEC is available from www.iec.ch. IEC has no responsibility for the placement and context in which the extracts and contents are reproduced by the author, nor is IEC in any way responsible for the other content or accuracy therein.

IEC 60079-14 ed.5.0 Copyright © 2013 IEC Geneva, Switzerland. www.iec.ch

Bi-metallic Corrosion

Material Information

Bi-metallic Corrosion

Bi-metallic corrosion occurs when two metals, with different potentials, are in electrical contact while immersed/in contact in an electrically conducting corrosive liquid/atmosphere. Because the metals have different natural potentials, a current will flow from the anode (more electronegative) metal to the cathode (more electropositive), which will increase the corrosion on the anode.

This additional corrosion is bi-metallic corrosion. It is also referred to as a galvanic corrosion, dissimilar metal corrosion or contact corrosion. The electrode potential is determined by many factors but the only fluid/atmospheres for which these factors are really well documented is sea water.

The value of the potential for any alloy, even in sea water, can be changed by a variety of factors such as temperature, velocity, biocide treatment, etc. The selection tables below are thereby indicative.

Key Corrosion Prevention Points

- Don't mix metals. If only one material is used in a construction, the problem is avoided.
- Consider area effect to avoid bi-metallic corrosion. The area effect should also be considered in avoiding corrosion damage.
- Remember stainless steels, such as 316L, have a thin, protective oxidized film and while this is intact, corrosion rates are very low and the alloy is said to be in its passive state.
- The bi-metallic corrosion rate of many copper-based and of stainless steels in sea water, depends upon the flow rate of the water as well as on the area ratio. Natural brass alloys tend to become less noble with increasing flow rate and to corrode more - thereby, plating brass will improve the performance, while stainless steels become more noble and corrode less. In well aerated flowing solutions, stainless steels are also likely to become passive and corrode less.



Indoor Use

CABLE GLAND SERIES	ENCLOSURE				
	316 STAINLESS STEEL	STEEL	BRASS	ALUMINUM	NON-METALLIC
Nickel-plated brass	S	S	S	S	S
316L stainless steel	S	S	S	S	S
Aluminum	S	L	L	S	S
Polyamide	S	S	S	S	S

Outdoor Use in Sea Water Environment

Nickel-plated brass	L	NC	S	NC	S
316L stainless steel	S	L	L	NC	S
Aluminum	NC	NC	NC	S	S
Polyamide	S	S	S	S	S

- S** Suitable
- L** Limited corrosion
- NC** Not compliant; severe corrosion - do not use

Thread Dimension Guide

Thread Lengths

ADE - CABLE GLAND RANGE			
THREAD SIZE ISO	STANDARD LENGTH	THREAD SIZE NPT	STANDARD LENGTH
12	15.0	3/8" NPT	16.6
16	15.0	1/2" NPT	22.2
20	15.0	3/4" NPT	22.5
25	15.0	1" NPT	27.3
32	15.0	1 1/4" NPT	28.0
40	15.0	1 1/2" NPT	28.5
50	16.0	2" NPT	29.2
63	17.0	2 1/2" NPT	42.5
75	18.0	3" NPT	44.0
90	22.0	3 1/2" NPT	45.2
110	22.0	4" NPT	46.5

All dimensions in mm.

NEWCAP - CABLE GLAND RANGE				
THREAD SIZE ISO	STANDARD LENGTH	LONG LENGTH	THREAD SIZE Pg	STANDARD LENGTH
12	6.5	15.0	Pg 7	6.5
16	6.5	15.0	Pg 9	6.5
20	6.5	15.0	Pg 11	6.5
25	7.0	15.0	Pg 13.5	6.5
32	8.0	15.0	Pg 16	7.0
40	8.0	15.0	Pg 21	8.0
50	9.0	15.0	Pg 29	8.0
63	10.0	15.0	Pg 36	9.0
			Pg 48	10.0

All dimensions in mm.

Thread Pitch

ISOMETRIC - (ISO) to BS 3643:1981			
SIZE	MAJOR DIAMETER (MM)	THREADS PER INCH	PITCH
16mm (M16)	16	16.93	1.50
20mm (M20)	20	16.93	1.50
25mm (M25)	25	16.93	1.50
32mm (M32)	32	16.93	1.50
40mm (M40)	40	16.93	1.50
50mm (M50)	50	16.93	1.50
63mm (M63)	63	16.93	1.50
75mm (M75)	75	16.93	1.50

All dimensions in mm.

NATIONAL PIPE THREAD - (NPT) to ANSI / ASME: 1983			
SIZE	MAJOR DIAMETER (MM)	THREADS PER INCH	PITCH
1/8" NPT	10.30	27	0.94
1/4" NPT	13.72	18	1.41
3/8" NPT	17.15	18	1.41
1/2" NPT	21.34	14	1.81
3/4" NPT	26.67	14	1.81
1" NPT	33.40	11 1/2	2.20
1 1/4" NPT	42.16	11 1/2	2.20
1 1/2" NPT	48.26	11 1/2	2.20
2" NPT	60.33	11 1/2	2.20
2 1/2" NPT	73.03	8	3.175
3" NPT	88.90	8	3.175
4" NPT	114.30	8	3.175

All dimensions in mm.

PANZERGEWINDE - (Pg) to EN 40430			
SIZE	MAJOR DIAMETER (MM)	THREADS PER INCH	PITCH
Pg 7	12.5	20	1.2700
Pg 9	15.5	18	1.4112
Pg 11	18.6	18	1.4112
Pg 13.5	20.4	18	1.4112
Pg 16	22.5	18	1.4112
Pg 21	28.3	16	1.5875
Pg 29	37.0	16	1.5875
Pg 36	47.0	16	1.5875
Pg 42	54.0	16	1.5875
Pg 48	59.3	16	1.5875

All dimensions in mm.

Ordering Using ADE Catalog Numbers

SERIES	THREAD SIZE	CABLE SEALING RANGE	MATERIAL	SEALING TYPE	OPTION
ADE2	M25	3	NP	N	

Variant codes & options

SERIES CODE	ADE MODEL	RANGE CODE	CABLE SEALING RANGE	MATERIAL CODE	MATERIAL (Gland body)	BARRIER CODE	BARRIER TYPE (ADE 1FC/6FC only)	SEALING CODE	SEALING TYPE	OPTION CODE	OPTION
ADE1	ADE 1F2	0	Extra Small (XS)	NP	Nickel-plated brass	SC	Solid Compound			K1	Accessories Kit 1
ADE2	ADE 1F2 DS	1	Small (S)							K2	Accessories Kit 2
ADE1A	ADE 1F2 (with integral clamping module)	2	Medium (M)	SS	Stainless Steel					K3	Accessories Kit 3
ADE1C	ADE 1FC	3	Large (L)	BZ	Bronze					FL	Flange (Integrated Clamping)
ADE4	ADE 4F			AL	Aluminum			N	Neoprene	BLANK	No Option
ADE5	ADE 5F							S	Silicone		
ADE6	ADE 6F										
ADE6C	ADE 6FC										

Notes:

- The 'barrier' section of the codes should only be used for ADE 1FC and ADE 6FC models.
- Not all options are available for all models; please check individual models for details.

KIT CODE	KIT OPTION
K1	Kit 1 Contents: <ul style="list-style-type: none"> Locknut Green Fiber Washer
K2	Kit 2 Contents: <ul style="list-style-type: none"> Locknut Green Fiber Washer Earth Tag Shroud
K3	Kit 3 Contents: <ul style="list-style-type: none"> Locknut Green Fiber Washer Earth Tag Serrated Washer

Ordering Using CAP Material Codes

If orders are placed using the 'CAP' numbers or converting from/to catalog (ADE) numbers, please ensure you have the correct digit for the material required. Consult the CAP Ordering Example for details.

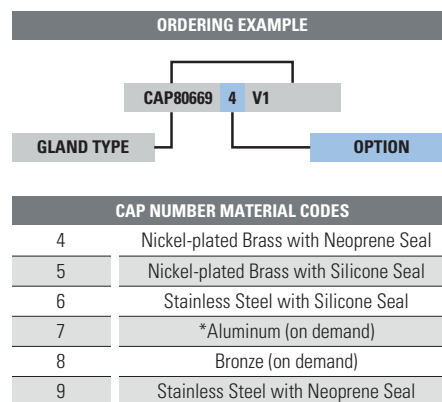

For material options, replace the last digit of the gland CAP code before the 'V1' suffix; for example:

CAP806694V1 = ADE 1F2 M20 Size 5 Nickel-plated Brass with Neoprene Seal

Change the digit before the 'V1' suffix:

CAP806699V1 = ADE 1F2 M20 Size 5 Stainless Steel with Neoprene Seal

*Compound glands (ADE 1FC & 6FC) not available in aluminum.

ADE - CAP Catalog Numbers

ADE 1F2

GLAND SELECTION			GLAND SIZE	CAP NUMBER ISO	CATALOG NUMBER ISO
SERIES	THREAD SIZE CODE	CABLE SEALING RANGE			
ADE1	M12	3	4	CAP806404V1	ADE1M123NPN
ADE1	M16	2	4	CAP806594V1	ADE1M162NPN
ADE1	M16	3	5	CAP806504V1	ADE1M163NPN
ADE1	M20	0	3	CAP806664V1	ADE1M200NPN
ADE1	M20	1	4	CAP806674V1	ADE1M201NPN
ADE1	M20	2	5	CAP806694V1	ADE1M202NPN
ADE1	M20	3	6	CAP806604V1	ADE1M203NPN
ADE1	M25	1	5	CAP806774V1	ADE1M251NPN
ADE1	M25	2	6	CAP806794V1	ADE1M252NPN
ADE1	M25	3	7	CAP806704V1	ADE1M253NPN
ADE1	M32	3	8	CAP806804V1	ADE1M323NPN
ADE1	M40	3	9	CAP806904V1	ADE1M403NPN
ADE1	M50	1	10	CAP807004V1	ADE1M501NPN
ADE1	M50	2	11	CAP807084V1	ADE1M502NPN
ADE1	M63	3	12	CAP807204V1	ADE1M633NPN
ADE1	M75	3	13	CAP807304V1	ADE1M753NPN
ADE1	M90	2	14	CAP807594V1	ADE1M902NPN
ADE1	M90	3	15	CAP807504V1	ADE1M903NPN
ADE1	M110	2	16	CAP807604V1	ADE1M1102NPN
ADE1	M110	3	17	CAP807704V1	ADE1M1103NPN

GLAND SELECTION			GLAND SIZE	CAP NUMBER ISO	CATALOG NUMBER ISO
THREAD SIZE	THREAD SIZE CODE	CABLE SEALING RANGE			
1/4"	N025	3	4	CAP808404V1	ADE1N0500NPN
3/8"	N038	2	4	CAP808594V1	ADE1N0382NPN
3/8"	N038	3	5	CAP808504V1	ADE1N0383NPN
1/2"	N050	0	3	CAP808404V1	ADE1N0500NPN
1/2"	N050	1	4	CAP808674V1	ADE1N0501NPN
1/2"	N050	2	5	CAP808694V1	ADE1N0502NPN
1/2"	N050	3	6	CAP808604V1	ADE1N0503NPN
3/4"	N075	1	5	CAP808774V1	ADE1N0751NPN
3/4"	N075	2	6	CAP808794V1	ADE1N0752NPN
3/4"	N075	3	7	CAP808704V1	ADE1N0753NPN
1"	N100	3	8	CAP808804V1	ADE1N1003NPN
1 1/4"	N125	3	9	CAP808904V1	ADE1N1253NPN
1 1/2"	N150	1	10	CAP809004V1	ADE1N1501NPN
2"	N200	2	11	CAP809294V1	ADE1N2002NPN
2"	N200	3	12	CAP809204V1	ADE1N2003NPN
2 1/2"	N250	3	13	CAP809404V1	ADE1N2503NPN
3"	N300	2	14	CAP809594V1	ADE1N3002NPN
3"	N300	3	15	CAP809504V1	ADE1N3003NPN
3 1/2"	N350	2	16	CAP809604V1	ADE1N3502NPN
4"	N400	3	17	CAP809704V1	ADE1N4003NPN

ADE 1F2 DS

ADE2	M12	3	4	CAP826404V1	ADE2M123NPN
ADE2	M16	2	4	CAP826594V1	ADE2M162NPN
ADE2	M16	3	5	CAP826504V1	ADE2M163NPN
ADE2	M20	0	3	CAP826664V1	ADE2M200NPN
ADE2	M20	1	4	CAP826674V1	ADE2M201NPN
ADE2	M20	2	5	CAP826694V1	ADE2M202NPN
ADE2	M20	3	6	CAP826684V1	ADE2M203NPN
ADE2	M25	1	5	CAP826764V1	ADE2M251NPN
ADE2	M25	2	6	CAP826774V1	ADE2M252NPN
ADE2	M25	3	7	CAP826784V1	ADE2M253NPN
ADE2	M32	3	8	CAP826884V1	ADE2M323NPN
ADE2	M40	3	9	CAP826984V1	ADE2M403NPN
ADE2	M50	2	10	CAP827074V1	ADE2M501NPN
ADE2	M50	3	11	CAP827084V1	ADE2M502NPN
ADE2	M63	3	12	CAP827284V1	ADE2M633NPN
ADE2	M75	3	13	CAP827304V1	ADE2M753NPN
ADE2	M90	2	14	CAP827594V1	ADE2M902NPN
ADE2	M90	3	15	CAP827504V1	ADE2M903NPN
ADE2	M110	2	16	CAP827604V1	ADE2M1102NPN
ADE2	M110	3	17	CAP827704V1	ADE2M1103NPN

-	-	-	-	-	-
-	-	-	-	-	-
-	-	-	-	-	-
1/2"	N050	0	3	CAP828664V1	ADE2N0500NPN
1/2"	N050	1	4	CAP828674V1	ADE2N0501NPN
1/2"	N050	2	5	CAP828694V1	ADE2N0502NPN
1/2"	N050	3	6	CAP828604V1	ADE2N0503NPN
3/4"	N075	1	5	CAP828704V1	ADE2N0753NPN
3/4"	N075	2	6	CAP828774V1	ADE2N0751NPN
3/4"	N075	3	7	CAP828794V1	ADE2N0752NPN
1"	N100	3	8	CAP828804V1	ADE2N1003NPN
1 1/4"	N125	3	9	CAP828904V1	ADE2N1253NPN
1 1/2"	N150	2	10	CAP829004V1	ADE2N1501NPN
2"	N200	3	11	CAP829294V1	ADE2N2002NPN
2"	N200	3	12	CAP829204V1	ADE2N2003NPN
2 1/2"	N250	3	13	CAP829404V1	ADE2N2503NPN
3"	N300	2	14	CAP829594V1	ADE2N3002NPN
3"	N300	3	15	CAP829504V1	ADE2N3003NPN
3 1/2"	N350	2	16	CAP829604V1	ADE2N3502NPN
4"	N400	3	17	CAP829704V1	ADE2N4003NPN

ADE 1F2 Clamp

ADE1A	M16	2	4	CAP036594V1	ADE1AM162NPN
ADE1A	M16	3	5	CAP036504V1	ADE1AM163NPN
ADE1A	M20	0	3	CAP036664V1	ADE1AM200NPN
ADE1A	M20	1	4	CAP036674V1	ADE1AM201NPN
ADE1A	M20	2	5	CAP036694V1	ADE1AM202NPN
ADE1A	M20	3	6	CAP036604V1	ADE1AM203NPN
ADE1A	M25	1	5	CAP036774V1	ADE1AM251NPN
ADE1A	M25	2	6	CAP036794V1	ADE1AM252NPN
ADE1A	M25	3	7	CAP036704V1	ADE1AM253NPN
ADE1A	M32	3	8	CAP036804V1	ADE1AM323NPN
ADE1A	M40	3	9	CAP036904V1	ADE1AM403NPN

-	-	-	-	-	-
-	-	-	-	-	-
1/2"	N050	0	3	CAP038664V1	ADE1AN0500NPN
1/2"	N050	1	4	CAP038674V1	ADE1AN0501NPN
1/2"	N050	2	5	CAP038694V1	ADE1AN0502NPN
1/2"	N050	3	6	CAP038604V1	ADE1AN0503NPN
3/4"	N075	1	5	CAP038774V1	ADE1AN0751NPN
3/4"	N075	2	6	CAP038794V1	ADE1AN0752NPN
3/4"	N075	3	7	CAP038704V1	ADE1AN0753NPN
1"	N100	3	8	CAP038804V1	ADE1AN1003NPN
-	-	-	-	-	-

ADE - CAP Catalog Numbers

ADE 1FC

GLAND SELECTION			GLAND SIZE	CAP NUMBER ISO	CATALOG NUMBER ISO
SERIES	THREAD SIZE CODE	CABLE SEALING RANGE			
ADE1C	M16	3	4	CAP019594V1	ADE1CM163NPSCN
ADE1C	M20	1	4	CAP019674V1	ADE1CM201NPSCN
ADE1C	M20	2	5	CAP019694V1	ADE1CM202NPSCN
ADE1C	M20	3	6	CAP019604V1	ADE1CM203NPSCN
ADE1C	M25	2	6	CAP019794V1	ADE1CM252NPSCN
ADE1C	M25	3	7	CAP019704V1	ADE1CM253NPSCN
ADE1C	M32	2	7	CAP019894V1	ADE1CM322NPSCN
ADE1C	M32	3	8	CAP019804V1	ADE1CM323NPSCN
ADE1C	M40	2	8	CAP019994V1	ADE1CM402NPSCN
ADE1C	M40	3	9	CAP019904V1	ADE1CM403NPSCN
ADE1C	M50	2	9	CAP019094V1	ADE1CM502NPSCN
ADE1C	M50	1	10	CAP019004V1	ADE1CM501NPSCN
ADE1C	M63	2	11	CAP019294V1	ADE1CM632NPSCN
ADE1C	M63	3	12	CAP019274V1	ADE1CM633NPSCN
ADE1C	-	-	-	-	-
ADE1C	M75	3	13	CAP019304V1	ADE1CM753NPSCN
ADE1C	-	-	-	-	-
ADE1C	M90	2	14	CAP010594V1	ADE1CM902NPSCN
ADE1C	-	-	-	-	-
ADE1C	M90	3	15	CAP010504V1	ADE1CM903NPSCN
ADE1C	-	-	-	-	-
ADE1C	M110	3	16	CAP010794V1	ADE1CM1103NPSCN

GLAND SELECTION			GLAND SIZE	CAP NUMBER ISO	CATALOG NUMBER ISO
THREAD SIZE	THREAD SIZE CODE	CABLE SEALING RANGE			
3/8"	N038	3	4	CAP011594V1	ADE1CN0383NPSCN
1/2"	N050	1	4	CAP011674V1	ADE1CN0501NPSCN
1/2"	N050	2	5	CAP011694V1	ADE1CN0502NPSCN
1/2"	N050	3	6	CAP011604V1	ADE1CN0503NPSCN
3/4"	N075	2	6	CAP011794V1	ADE1CN0752NPSCN
3/4"	N075	3	7	CAP011704V1	ADE1CN0753NPSCN
1"	N100	2	7	CAP011894V1	ADE1CN1002NPSCN
1"	N100	3	8	CAP011804V1	ADE1CN1003NPSCN
1 1/4"	N125	2	8	CAP011994V1	ADE1CN1252NPSCN
1 1/4"	N125	3	9	CAP011904V1	ADE1CN1253NPSCN
1 1/2"	N150	2	9	CAP011094V1	ADE1CN1502NPSCN
2"	N200	1	10	CAP011004V1	ADE1CN2001NPSCN
2"	N200	2	11	CAP011294V1	ADE1CN2002NPSCN
2"	N200	3	12	CAP011204V1	ADE1CN2003NPSCN
2 1/2"	N250	2	12	CAP011494V1	ADE1CN2502NPSCN
2 1/2"	N250	3	13	CAP011404V1	ADE1CN2503NPSCN
3"	N300	1	13	CAP012504V1	ADE1CN3001NPSCN
3"	N300	2	14	CAP012574V1	ADE1CN3002NPSCN
3 1/2"	N350	2	14	CAP012604V1	ADE1CN3502NPSCN
3"	N300	3	15	CAP012594V1	ADE1CN3003NPSCN
3 1/2"	N350	3	15	CAP012694V1	ADE1CN3503NPSCN
4"	N400	3	16	CAP012704V1	ADE1CN4003NPSCN

ADE 4F

ADE4	M12	3	5	CAP846404V1	ADE4M123NPN
ADE4	M16	1	4	CAP846574V1	ADE4M161NPN
ADE4	M16	2	5	CAP846594V1	ADE4M162NPN
ADE4	M16	3	6	CAP846504V1	ADE4M163NPN
ADE4	M20	0	4	CAP846654V1	ADE4M200NPN
ADE4	M20	1	5	CAP846674V1	ADE4M201NPN
ADE4	M20	2	6	CAP846694V1	ADE4M202NPN
ADE4	M20	3	7	CAP846604V1	ADE4M203NPN
ADE4	M25	1	6	CAP846774V1	ADE4M251NPN
ADE4	M25	2	7	CAP846794V1	ADE4M252NPN
ADE4	M25	3	8	CAP846704V1	ADE4M253NPN
ADE4	M32	2	8	CAP846894V1	ADE4M322NPN
ADE4	M32	3	9	CAP846804V1	ADE4M323NPN
ADE4	M40	2	9	CAP846994V1	ADE4M402NPN
ADE4	M40	3	10	CAP846904V1	ADE4M403NPN
ADE4	M50	2	10	CAP847094V1	ADE4M502NPN
ADE4	M50	3	11	CAP847004V1	ADE4M503NPN
ADE4	M63	2	12	CAP847294V1	ADE4M632NPN
ADE4	M63	3	13	CAP847204V1	ADE4M633NPN
ADE4	M75	2	13	CAP847394V1	ADE4M752NPN
ADE4	M75	3	14	CAP847304V1	ADE4M753NPN
ADE4	M90	1	15	CAP847594V1	ADE4M901NPN
ADE4	M90	2	16	CAP847504V1	ADE4M902NPN
ADE4	M90	3	17	CAP847574V1	ADE4M903NPN
ADE4	M110	3	17	CAP847794V1	ADE4M1103NPN

1/4"	N025	3	5	CAP848404V1	ADE4N0253NPN
3/8"	N038	1	4	CAP848574V1	ADE4N0381NPN
3/8"	N038	2	5	CAP848594V1	ADE4N0382NPN
3/8"	N038	3	6	CAP848504V1	ADE4N0383NPN
1/2"	N050	0	4	CAP848664V1	ADE4N0500NPN
1/2"	N050	1	5	CAP848674V1	ADE4N0501NPN
1/2"	N050	2	6	CAP848694V1	ADE4N0502NPN
1/2"	N050	3	7	CAP848604V1	ADE4N0503NPN
3/4"	N075	1	6	CAP848774V1	ADE4N0751NPN
3/4"	N075	2	7	CAP848794V1	ADE4N0752NPN
3/4"	N075	3	8	CAP848704V1	ADE4N0753NPN
1"	N100	2	8	CAP848894V1	ADE4N1002NPN
1"	N100	3	9	CAP848804V1	ADE4N1003NPN
1 1/4"	N125	2	9	CAP848994V1	ADE4N1252NPN
1 1/4"	N125	3	10	CAP848904V1	ADE4N1253NPN
1 1/2"	N150	2	10	CAP849094V1	ADE4N1502NPN
1 1/2"	N150	3	11	CAP849004V1	ADE4N1503NPN
2"	N200	2	12	CAP849294V1	ADE4N2002NPN
2"	N200	3	13	CAP849204V1	ADE4N2003NPN
2 1/2"	N250	2	13	CAP849494V1	ADE4N2502NPN
2 1/2"	N250	3	14	CAP849404V1	ADE4N2503NPN
3"	N300	1	15	CAP849594V1	ADE4N3001NPN
3"	N300	2	16	CAP849504V1	ADE4N3002NPN
3 1/2"	N350	3	17	CAP849604V1	ADE4N3503NPN
4"	N400	3	17	CAP849704V1	ADE4N4003NPN

ADE - CAP Catalog Numbers

ADE 5F

GLAND SELECTION			GLAND SIZE	CAP NUMBER ISO	CATALOG NUMBER ISO
SERIES	THREAD SIZE CODE	CABLE SEALING RANGE			
ADE5	M12	3	5	CAP856404V1	ADE5M123NPN
ADE5	M16	2	5	CAP856594V1	ADE5M162NPN
ADE5	M16	3	6	CAP856504V1	ADE5M163NPN
ADE5	M20	1	5	CAP856674V1	ADE5M201NPN
ADE5	M20	2	6	CAP856694V1	ADE5M202NPN
ADE5	M20	3	7	CAP856604V1	ADE5M203NPN
ADE5	M25	1	6	CAP856774V1	ADE5M251NPN
ADE5	M25	2	7	CAP856794V1	ADE5M252NPN
ADE5	M25	3	8	CAP856704V1	ADE5M253NPN
ADE5	M32	2	8	CAP856894V1	ADE5M322NPN
ADE5	M32	3	9	CAP856804V1	ADE5M323NPN
ADE5	M40	2	9	CAP856994V1	ADE5M402NPN
ADE5	M40	3	10	CAP856904V1	ADE5M403NPN
ADE5	M50	2	10	CAP857094V1	ADE5M502NPN
ADE5	M50	3	11	CAP857004V1	ADE5M503NPN
ADE5	M63	2	12	CAP857294V1	ADE5M632NPN
ADE5	M63	3	13	CAP857204V1	ADE5M633NPN
ADE5	M75	2	13	CAP857394V1	ADE5M752NPN
ADE5	M75	3	14	CAP857304V1	ADE5M753NPN
ADE5	M90	2	15	CAP857594V1	ADE5M901NPN
ADE5	M90	3	16	CAP857504V1	ADE5M902NPN
ADE5	M90	3	17/16	CAP857584V1	ADE5M903NPN
ADE5	M110	3	17	CAP857794V1	ADE5M1103NPN

GLAND SELECTION			GLAND SIZE	CAP NUMBER ISO	CATALOG NUMBER ISO
THREAD SIZE	THREAD SIZE CODE	CABLE SEALING RANGE			
1/4"	N025	3	5	CAP858404V1	ADE5N0253NPN
3/8"	N038	2	5	CAP858594V1	ADE5N0382NPN
3/8"	N038	3	6	CAP858504V1	ADE5N0383NPN
1/2"	N050	1	5	CAP858674V1	ADE5N0501NPN
1/2"	N050	2	6	CAP858694V1	ADE5N0502NPN
1/2"	N050	3	7	CAP858604V1	ADE5N0503NPN
3/4"	N075	1	6	CAP858774V1	ADE5N0751NPN
3/4"	N075	2	7	CAP858794V1	ADE5N0752NPN
3/4"	N075	3	8	CAP858704V1	ADE5N0753NPN
1"	N100	2	8	CAP858894V1	ADE5N1002NPN
1"	N100	3	9	CAP858804V1	ADE5N1003NPN
1 1/4"	N125	2	9	CAP858994V1	ADE5N1252NPN
1 1/4"	N125	3	10	CAP858904V1	ADE5N1253NPN
1 1/2"	N150	2	10	CAP859094V1	ADE5N1502NPN
1 1/2"	N150	3	11	CAP859004V1	ADE5N1503NPN
2"	N200	2	12	CAP859294V1	ADE5N2002NPN
2"	N200	3	13	CAP859204V1	ADE5N2003NPN
2 1/2"	N250	2	13	CAP859494V1	ADE5N2502NPN
2 1/2"	N250	3	14	CAP859404V1	ADE5N2503NPN
3"	N300	2	15	CAP859594V1	ADE5N3001NPN
3"	N300	3	16	CAP859504V1	ADE5N3002NPN
3 1/2"	N350	3	17/16	CAP859604V1	ADE5N3503NPN
4"	N400	3	17	CAP859704V1	ADE5N4003NPN

ADE 6F

ADE6	M16	3	5	CAP965595V1	ADE6M163NPS
ADE6	M20	1	5	CAP965675V1	ADE6M201NPS
ADE6	M20	2	6	CAP965695V1	ADE6M202NPS
ADE6	M20	3	7	CAP965605V1	ADE6M203NPS
ADE6	M25	2	7	CAP965795V1	ADE6M252NPS
ADE6	M25	3	8	CAP965705V1	ADE6M253NPS
ADE6	M32	2	8	CAP965895V1	ADE6M322NPS
ADE6	M32	3	9	CAP965805V1	ADE6M323NPS
ADE6	M40	2	9	CAP965995V1	ADE6M402NPS
ADE6	M40	3	10	CAP965905V1	ADE6M403NPS
ADE6	M50	2	10	CAP966095V1	ADE6M502NPS
ADE6	M50	3	11	CAP966005V1	ADE6M503NPS

3/8"	N038	3	5	CAP967595V1	ADE6N0383NPS
1/2"	N050	1	5	CAP967675V1	ADE6N0501NPS
1/2"	N050	2	6	CAP967695V1	ADE6N0502NPS
1/2"	N050	3	7	CAP967605V1	ADE6N0503NPS
3/4"	N075	2	7	CAP967795V1	ADE6N0752NPS
3/4"	N075	3	8	CAP967705V1	ADE6N0753NPS
1"	N100	2	8	CAP967895V1	ADE6N1002NPS
1"	N100	3	9	CAP967805V1	ADE6N1003NPS
1 1/4"	N125	2	9	CAP967995V1	ADE6N1252NPS
1 1/4"	N125	3	10	CAP967905V1	ADE6N1253NPS
1 1/2"	N150	2	10	CAP968095V1	ADE6N1502NPS
2"	N200	3	11	CAP968295V1	ADE6N2003NPS

ADE 6FC

ADE6C	M16	3	5	CAP969594V1	ADE6CM163NPSCN
ADE6C	M20	1	5	CAP969674V1	ADE6CM201NPSCN
ADE6C	M20	2	6	CAP969694V1	ADE6CM202NPSCN
ADE6C	M20	3	7	CAP969604V1	ADE6CM203NPSCN
ADE6C	M25	2	7	CAP969794V1	ADE6CM252NPSCN
ADE6C	M25	3	8	CAP969704V1	ADE6CM253NPSCN
ADE6C	M32	2	8	CAP969894V1	ADE6CM322NPSCN
ADE6C	M32	3	9	CAP969804V1	ADE6CM323NPSCN
ADE6C	M40	2	9	CAP969994V1	ADE6CM402NPSCN
ADE6C	M40	3	10	CAP969904V1	ADE6CM403NPSCN
ADE6C	M50	2	10	CAP970094V1	ADE6CM502NPSCN
ADE6C	M50	1	11	CAP970004V1	ADE6CM501NPSCN
ADE6C	M63	2	12	CAP970294V1	ADE6CM632NPSCN
ADE6C	M63	3	13	CAP970204V1	ADE6CM633NPSCN
ADE6C	M75	2	13	CAP970394V1	ADE6CM752NPSCN
ADE6C	M75	3	14	CAP970304V1	ADE6CM753NPSCN
ADE6C	-	-	-	-	-
ADE6C	M90	2	15	CAP970594V1	ADE6CM902NPSCN
ADE6C	-	-	-	-	-
ADE6C	M90	3	16	CAP970504V1	ADE6CM903NPSCN
ADE6C	-	-	-	-	-
ADE6C	M110	3	17	CAP970794V1	ADE6CM1103NPSCN

3/8"	N038	3	5	CAP971594V1	ADE6CN0383NPSCN
1/2"	N050	1	5	CAP971674V1	ADE6CN0501NPSCN
1/2"	N050	2	6	CAP971694V1	ADE6CN0502NPSCN
1/2"	N050	3	7	CAP971604V1	ADE6CN0503NPSCN
3/4"	N075	2	7	CAP971794V1	ADE6CN0752NPSCN
3/4"	N075	3	8	CAP971704V1	ADE6CN0753NPSCN
1"	N100	2	8	CAP971894V1	ADE6CN1002NPSCN
1"	N100	3	9	CAP971804V1	ADE6CN1003NPSCN
1 1/4"	N125	2	9	CAP971994V1	ADE6CN1252NPSCN
1 1/4"	N125	3	10	CAP971904V1	ADE6CN1253NPSCN
1 1/2"	N150	2	10	CAP972094V1	ADE6CN1502NPSCN
2"	N200	1	11	CAP972294V1	ADE6CN2001NPSCN
2"	N200	2	12	CAP972274V1	ADE6CN2002NPSCN
2"	N200	3	13	CAP972204V1	ADE6CN2003NPSCN
2 1/2"	N250	2	13	CAP972494V1	ADE6CN2502NPSCN
2 1/2"	N250	3	14	CAP972404V1	ADE6CN2503NPSCN
3"	N300	1	14	CAP972574V1	ADE6CN3001NPSCN
3"	N300	2	15	CAP972594V1	ADE6CN3002NPSCN
3 1/2"	N350	2	15	CAP972694V1	ADE6CN3502NPSCN
3"	N300	3	16	CAP972504V1	ADE6CN3003NPSCN
3 1/2"	N350	3	16	CAP972604V1	ADE6CN3503NPSCN
4"	N400	3	17	CAP972704V1	ADE6CN4003NPSCN



Eaton's Crouse-Hinds

The safety you rely on.

See the complete offering of Cable Glands and Accessories at www.crouse-hinds.com.

**U.S. (Global Headquarters):
Eaton's Crouse-Hinds Business**

1201 Wolf Street
Syracuse, NY 13208
(866) 764-5454
FAX: (315) 477-5179
FAX Orders Only:
(866) 653-0640
CrouseCustomerCTR@eaton.com

For more information:

If further assistance is required, please contact an authorized Eaton Distributor, Sales Office, or Customer Service Department.

Canada:

Toll Free: 800-265-0502
FAX: (800) 263-9504
FAX Orders only: (866) 653-0645

Mexico/LatinAmerica/Caribbean:

52-555-804-4000
FAX: 52-555-804-4020
ventascentromex@eaton.com

Europe (Germany):

49 (0) 6271 806-500
49 (0) 6271 806-476
sales.CCH.de@cooperindustries.com

Middle East (Dubai):

971 4 8066100
FAX: 971 4 8894813
chmesales@eaton.com

Singapore:

65-6645-9888
FAX: 65-6297-4819
chsi-sales@cooperindustries.com

China:

86-21-2899-3600
FAX: 86-21-2899-4055
cchsales@cooperindustries.com

Korea:

82-2-3484-6783
82-2-3484-6778
CCHK-sales@cooperindustries.com

Australia:

61-2-8787-2777
FAX: 61-2-9609-2342
CEASales@cooperindustries.com

India:

91-124-4683888
FAX: 91-124-4683899
cchindia@cooperindustries.com

Eaton

Capri SAS
36-40 Rue des Fontenils
41600 Nouan-le-Fuzelier France

T: +33 (0) 820 820 195

F: +33 (0) 820 820 924

W: www.crouse-hinds.com

Eaton's Crouse-Hinds Business

1201 Wolf Street
Syracuse, NY 13208

T: +1 (866) 764-5454

F: +1 (315) 477-5179

W: www.crouse-hinds.com

Eaton

1000 Eaton Boulevard
Cleveland, OH 44122
United States
Eaton.com

© 2015 Eaton Corporation
All Rights Reserved
Printed in UK
Publication No. CAP185006
July 2015

Eaton's Crouse-Hinds Business

1201 Wolf Street
Syracuse, NY 13208
(866) 764-5454
CrouseCustomerCTR@eaton.com

Eaton is a registered trademark.
All other trademarks are property
of their respective owners.

Crouse-Hinds
by **EATON**