

# Pauluhn ProConnect-PS 263 and 264 wiring devices

Conforms to IP66

11P

## Applications:

- Marine and watertight requirements

## Features:

- Unique pin and sleeve design prevents accidental mating of non-marine rated devices
- Available mating metal or non-metallic plugs with integral threaded ring maintain a watertight seal
- Neoprene gasket resists petroleum
- Water shedding inverted mounting style
- Reverse service feed available
- Extended cover provides additional wiring capacity
- Cast marine brass or copper-free aluminum construction available
- Captive threaded receptacle cap
- Optional two-pole rotary switch combinations
- Heavy duty mounting pads
- Silicone lubricant provided for cover screws and flange
- Available in 125 VAC, up to 600 VAC
- 2-pole, 3-wire or 3-pole, 4-wire units available
- 125 VAC, 20 ampere ANSI NEMA adapter plug available

## Certifications and compliances:

- Conforms to IP66
- ABS

## Standard materials:

- Plug body and ring – cast marine brass, zinc plated brass or Acrylonitrile Butadiene Styrene/polycarbonate blend (ABS+PC)
- Receptacle and plug interior – Acrylonitrile Butadiene Styrene/polycarbonate blend (ABS+PC)
- Box and cover – cast marine brass or copper-free aluminum
- Pins and sleeves – free machining brass
- Caps and ring – marine brass or zinc plated brass
- Hardware – stainless steel
- Gasket – one-piece neoprene

## Technical specifications:

- Entries – standard units undrilled; up to 3/4" NPT through feed available

### Voltage and current ratings:

#### Receptacle

- 125 VAC, 20 amperes maximum
- 208 VAC, 20 amperes maximum
- 250 VAC, 20 amperes maximum
- 277 VAC, 20 amperes maximum
- 480 VAC, 20 amperes maximum
- 600 VAC, 20 amperes maximum

#### Switch

- 20 amperes, 120/240 VAC
- 1 HP at 120 VAC or 2 HP at 240 VAC

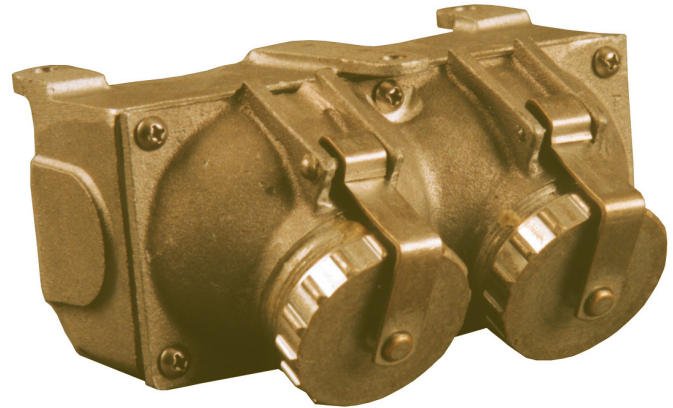

## Mounting options:

- Surface mount (via two/three) or flush mount (via four) 1/4" bolts (not included)

## Options:

Description	Suffix
• 208 VAC.....	<b>208<sup>A</sup></b>
<i>3-pole, 4-wire only</i>	
• 250 VAC.....	<b>250<sup>A</sup></b>
• 277 VAC.....	<b>277<sup>A</sup></b>
<i>2-pole, 3-wire only</i>	
• 480 VAC.....	<b>480<sup>A</sup></b>
• 600 VAC.....	<b>600<sup>A</sup></b>
<i>3-pole, 4-wire only</i>	
• Reverse service.....	<b>RS</b>
<i>Available with single-gang only</i>	

## Entry options:

NPT trade size	Dead end	Through feed
1/2"	E1	C1
3/4"	E2	C2

<sup>A</sup> Replace '125' in catalog number.

# Pauluhn ProConnect-PS 263 and 264 wiring devices

Conforms to IP66

11P  
11P

## Ordering information:

Cat. # 2-pole, 3-wire	Cat. # 3-pole, 4-wire	Description	Material	Weight (lbs.)
2632B-125	2633B-125	Surface mount, one receptacle	Marine brass	3.2
2634B-125	2635B-125	Surface mount, two receptacles	Marine brass	4.9
2636B-125	2637B-125	Surface mount, three receptacles	Marine brass	6.7
2640B-125	2641B-125	Surface mount, one receptacle with 2-pole switch	Marine brass	4.9
2634BF-125	2635BF-125	Flush mount, two receptacles	Marine brass	7.0
2640BF-125	2641BF-125	Flush mount, one receptacle with 2-pole switch	Marine brass	7.0
2632A-125	2633A-125	Surface mount, one receptacle	Aluminum	1.2
2634A-125	2635A-125	Surface mount, two receptacles	Aluminum	2.3
420BP-125	420-4BP-125	Plug	Metal	0.8
420PP-125	420-4PP-125	Plug	Plastic	0.3

## Dimensions (in inches):

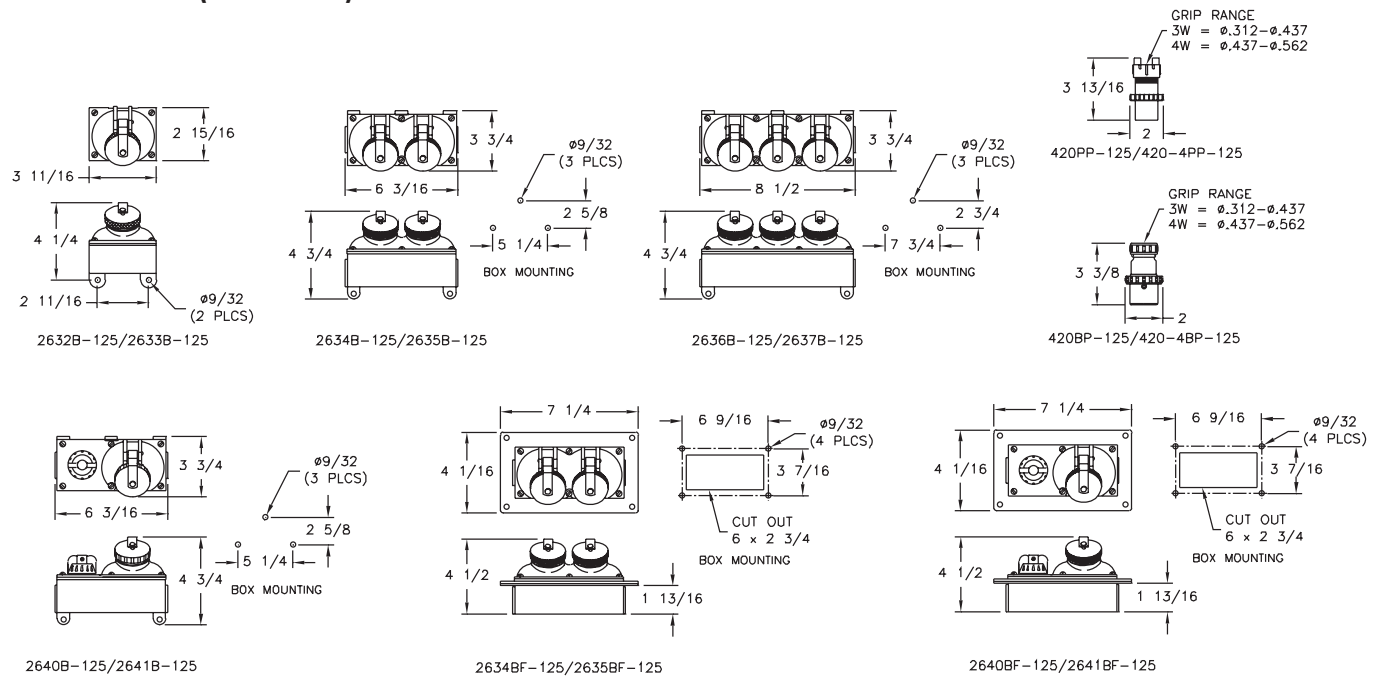

# Pauluhn ProConnect-PS 261 and 262 wiring devices

Conforms to IP66

11P

## Applications:

- Marine and watertight requirements

## Features:

- Unique pin and sleeve design prevents accidental mating of non-marine rated devices
- Available mating metal or non-metallic plugs with integral threaded ring maintain a watertight seal
- Neoprene gasket resists petroleum
- Reverse service feed available
- Extended cover provides additional wiring capacity
- Cast marine brass or copper-free aluminum construction available
- Captive threaded receptacle cap
- Optional two-pole rotary switch combinations
- Heavy duty mounting pads
- Silicone lubricant provided for cover screws and flange
- Available in 125 VAC, up to 600 VAC
- 2-pole, 3-wire or 3-pole, 4-wire units available
- 125 VAC, 20 ampere ANSI NEMA adapter plug available

## Certifications and compliances:

- Conforms to IP66
- ABS

## Standard materials:

- Plug body and ring – cast marine brass, zinc plated brass or Acrylonitrile Butadiene Styrene/polycarbonate blend (ABS+PC)
- Receptacle and plug interior – Acrylonitrile Butadiene Styrene/polycarbonate blend (ABS+PC)
- Box and cover – cast marine brass or copper-free aluminum
- Pins and sleeves – free machining brass
- Caps and ring – marine brass or zinc plated brass
- Hardware – stainless steel
- Gasket – one-piece neoprene

## Technical specifications:

- Entries – standard units undrilled; up to  $\frac{3}{4}$ " NPT through feed available

### Voltage and current ratings:

#### Receptacle

- 125 VAC, 20 amperes maximum
- 208 VAC, 20 amperes maximum
- 250 VAC, 20 amperes maximum
- 277 VAC, 20 amperes maximum
- 480 VAC, 20 amperes maximum
- 600 VAC, 20 amperes maximum

#### Switch

- 20 amperes, 120/240 VAC
- 1 HP at 120 VAC or 2 HP at 240 VAC

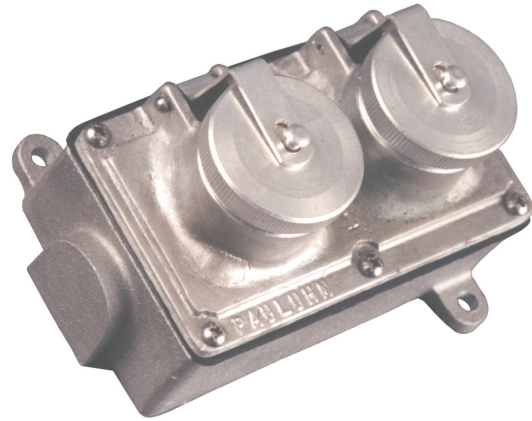

## Mounting options:

- Surface mount (via two) or flush mount (via four)  $\frac{1}{4}$ " bolts (not included)

## Options:

Description	Suffix
• 208 VAC..... <i>3-pole, 4-wire only</i>	<b>208<sup>A</sup></b>
• 250 VAC.....	<b>250<sup>A</sup></b>
• 277 VAC..... <i>2-pole, 3-wire only</i>	<b>277<sup>A</sup></b>
• 480 VAC.....	<b>480<sup>A</sup></b>
• 600 VAC..... <i>3-pole, 4-wire only</i>	<b>600<sup>A</sup></b>
• Reverse service..... <i>Available with single-gang only</i>	<b>RS</b>

## Entry options:

NPT trade size	Dead end	Through feed
$\frac{1}{2}$ "	E1	C1
$\frac{3}{4}$ "	E2	C2

<sup>A</sup>Replace '125' in catalog number.

# Pauluhn ProConnect-PS 261 and 262 wiring devices

Conforms to IP66

11P  
11P

## Ordering information:

Cat. # 2-pole, 3-wire	Cat. # 3-pole, 4-wire	Description	Material	Weight (lbs.)
2613B-125	2615B-125	Surface mount, one receptacle	Marine brass	4.0
2614B-125	2617B-125	Surface mount, two receptacles	Marine brass	5.5
2620B-125	2623B-125	Surface mount, one receptacle with switch	Marine brass	5.5
2613BF-125	2615BF-125	Flush mount, one receptacle	Marine brass	4.5
2614BF-125	2617BF-125	Flush mount, two receptacles	Marine brass	6.5
2620BF-125	2623BF-125	Flush mount, one receptacle with switch	Marine brass	6.5
2614A-125	2617A-125	Surface mount, two receptacles	Aluminum	2.3
420BP-125	420-4BP-125	Plug	Metal	0.8
420PP-125	420-4PP-125	Plug	Plastic	0.3

## Dimensions (in inches):

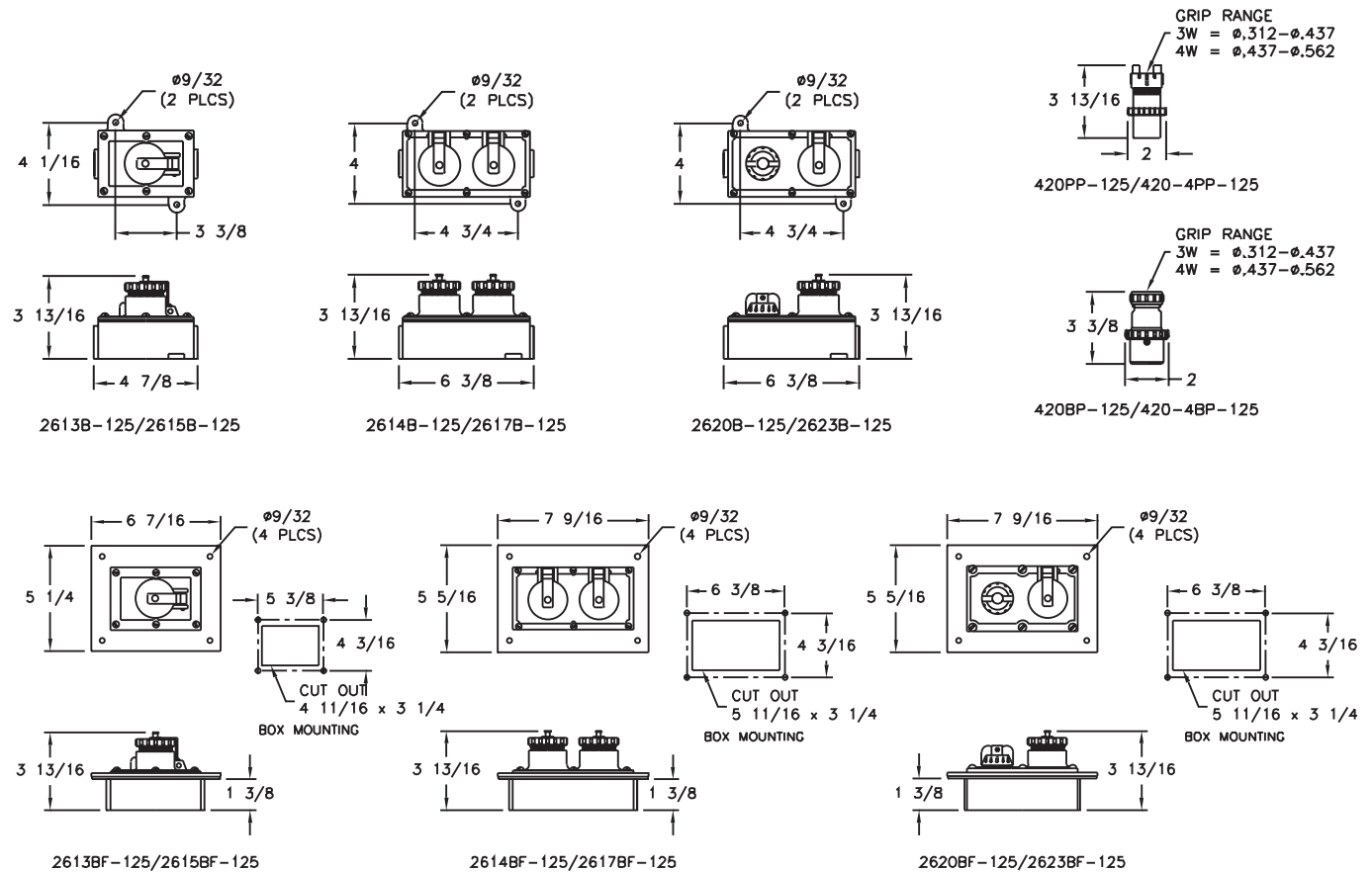

# Pauluhn ProConnect-PS 3100 and 3101 wiring devices

Conforms to IP66

11P

## Applications:

- Marine and watertight requirements

## Features:

- Unique pin and sleeve design prevents accidental mating of non-marine rated devices
- Available mating metal or non-metallic plugs with integral threaded ring maintain a watertight seal
- Neoprene gasket resists petroleum
- Reverse service feed available
- Extended back box provides additional wiring capacity
- Cast marine brass construction
- Captive threaded receptacle cap
- Heavy duty mounting pads
- Silicone lubricant provided for cover screws and flange
- Available in 125 VAC, up to 600 VAC
- 2-pole, 3-wire or 3-pole, 4-wire units available
- 125 VAC, 20 ampere ANSI NEMA adapter plug available

## Certifications and compliances:

- Conforms to IP66
- ABS

## Standard materials:

- Plug body and ring – cast marine brass or Acrylonitrile Butadiene Styrene/polycarbonate blend (ABS+PC)
- Receptacle and plug interior – Acrylonitrile Butadiene Styrene/polycarbonate blend (ABS+PC)
- Box and cover – cast marine brass
- Pins and sleeves – free machining brass
- Caps and ring – marine brass
- Hardware – stainless steel
- Gasket – one-piece neoprene

## Technical specifications:

- Entries – standard units undrilled; up to four 1" NPT outlets available

### Voltage and current ratings:

#### Receptacle

- 125 VAC, 20 amperes maximum
- 208 VAC, 20 amperes maximum
- 250 VAC, 20 amperes maximum
- 277 VAC, 20 amperes maximum
- 480 VAC, 20 amperes maximum
- 600 VAC, 20 amperes maximum



## Mounting options:

- Surface mount (via two) 1/4" bolts (not included)

## Options:

Description	Suffix
• 208 VAC.....	<b>208<sup>A</sup></b>
<i>3-pole, 4-wire only</i>	
• 250 VAC.....	<b>250<sup>A</sup></b>
• 277 VAC.....	<b>277<sup>A</sup></b>
<i>2-pole, 3-wire only</i>	
• 480 VAC.....	<b>480<sup>A</sup></b>
• 600 VAC.....	<b>600<sup>A</sup></b>
<i>3-pole, 4-wire only</i>	
• Reverse service.....	<b>RS</b>

## Entry options:

NPT trade size	Dead end <sup>ⓑ</sup>	Through feed <sup>ⓑ</sup>	X positions
1/2"	E1	C1	X1
3/4"	E2	C2	X2
1"	E3	C3	X3

<sup>A</sup> Replace '125' in catalog number.

<sup>B</sup> Entries on short side of casting.

# Pauluhn ProConnect-PS 3100 and 3101 wiring devices

Conforms to IP66

11P  
11P

## Ordering information:

Cat. # 2-pole, 3-wire	Cat. # 3-pole, 4-wire	Description	Weight (lbs.)
3100B-125	3101B-125	Single receptacle	4.3
420BP-125	420-4BP-125	Metal plug	0.8
420PP-125	420-4PP-125	Plastic plug	0.4

## Dimensions (in inches):

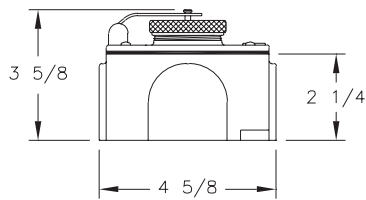
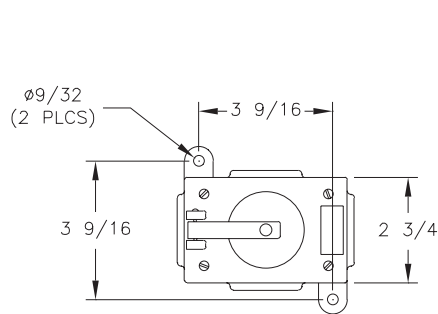

3100B-125/3101B-125

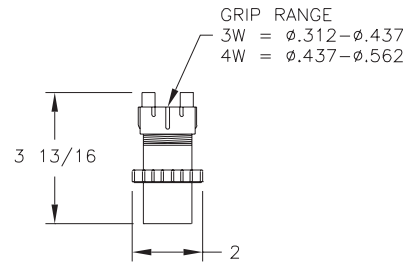

420PP-125/420-4PP-125

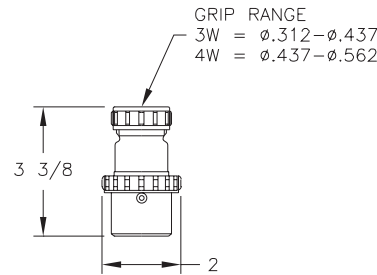

420BP-125/420-4BP-125

## Applications:

- Marine and watertight requirements

## Features:

- Unique pin and sleeve design prevents accidental mating of non-marine rated devices
- Available mating plug with integral threaded ring maintains a watertight seal
- Neoprene gasket resists petroleum
- Reverse service feed available
- Extended box and cover provides additional wiring capacity
- Cast marine brass construction
- Captive threaded receptacle cap
- Heavy duty mounting pads
- Silicone lubricant provided for cover screws and flange
- Available in 125 VAC, up to 600 VAC
- 2-pole, 3-wire or 3-pole, 4-wire units available

## Certifications and compliances:

- Conforms to IP66
- ABS

## Standard materials:

- Plug body and ring – cast marine brass
- Receptacle and plug interior – Acrylonitrile Butadiene Styrene/polycarbonate blend (ABS+PC)
- Box, cover and cap – cast marine brass
- Pins and sleeves – free machining brass
- Hardware – stainless steel
- Gasket – one-piece neoprene

## Technical specifications:

- Entries – standard units undrilled; up to four 1" NPT outlets available

### Voltage and current ratings:

#### Receptacle

- 125 VAC, 30 amperes maximum
- 250 VAC, 30 amperes maximum
- 277 VAC, 30 amperes maximum
- 380 VAC, 30 amperes maximum
- 480 VAC, 30 amperes maximum
- 600 VAC, 30 amperes maximum

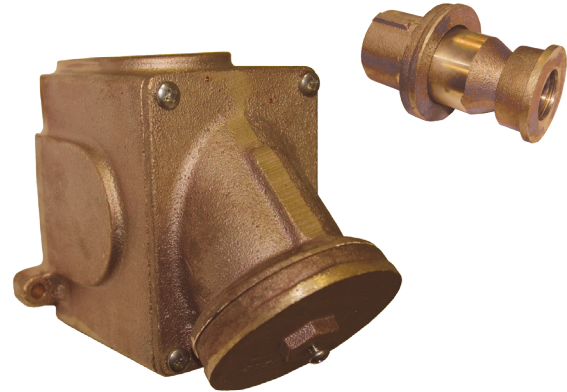

## Mounting options:

- Surface mount (via two) 1/4" bolts (not included)

## Options:

Description	Suffix
• 250 VAC.....	<b>250<sup>A</sup></b>
• 277 VAC.....	<b>277<sup>A</sup></b>
• 380 VAC.....	<b>380<sup>A</sup></b>
• 480 VAC.....	<b>480<sup>A</sup></b>
• 600 VAC.....	<b>600<sup>A</sup></b>
• Reverse service.....	<b>RS</b>

## Entry options:

NPT trade size	Dead end <sup>B</sup>	Through feed <sup>B</sup>	X positions
1/2"	E1	C1	X1
3/4"	E2	C2	X2
1"	E3	C3	X3

<sup>A</sup> Replace '125' in catalog number.

<sup>B</sup> Entries on short side of casting.

## Ordering information:

Cat. # 2-pole, 3-wire	Cat. # 3-pole, 4-wire	Description	Weight (lbs.)
6009B-125	6006B-125	Angle type	7.8
6009BP-125	6006BP-125	Plug	2.8

## Dimensions (in inches):

