

STAINLESS STEEL-PRESSURE FILTER, change-over

Series EDA 1015 NPS 4" CLASS 150 PSI

Sheet No.
2171 C

1. Type index:

1.1. Complete filter: (ordering example)

EDA. 1015. 10VG. 10. B. P. VA. FS. B. -. -. AE. AV. IS21. F. F

1	2	3	4	5	6	7	8	9	10	11	12	13	14	15	16
---	---	---	---	---	---	---	---	---	----	----	----	----	----	----	----

- 1 series:
EDA = stainless steel-pressure filter change-over, according to ASME-code
- 2 nominal size: 1015
- 3 filter-material and filter- fineness:
80 G = 80 μm , 40 G = 40 μm , 25 G = 25 μm , 10 G = 10 μm stainless steel wire mesh
25 VG = 20 $\mu\text{m}_{(c)}$, 16 VG = 15 $\mu\text{m}_{(c)}$, 10 VG = 10 $\mu\text{m}_{(c)}$, 6 VG = 7 $\mu\text{m}_{(c)}$, 3 VG = 5 $\mu\text{m}_{(c)}$ Interpor fleece (glass fiber)
25 API = 20 μm , 10 API = 10 μm Interpor fleece (glass fiber) according to API
10 P = 10 μm paper
- 4 resistance of pressure difference for filter element:
10 = Δp 145 PSI
- 5 filter element design:
B = both-sides open
- 6 sealing material:
P = Nitrile (NBR), V = Viton (FPM)
- 7 filter element specification:
- = standard, VA = stainless steel
- 8 process connection:
FS = SAE-flange connection 3000 PSI
FA11 = ANSI-flange connection CLASS 150 PSI, sealing surface rough grind 1600-3600 μin
FA12 = ANSI-flange connection CLASS 150 PSI, sealing surface rough grind < 640 μin
- 9 process connection size:
B = 4"
- 10 filter housing specification: (material) see sheet-no. 55050
- = standard, per according to specification pressure vessel DGRL (1.4404) / ASME type 316L
- 11 internal valve:
- = without, S1 = with by-pass valve Δp 51 PSI
- 12 clogging indicator or clogging sensor:
- = without, OP = visual, see sheet-no. 1628
AOR = visual, see sheet-no. 1606, OE = visual-electrical, see sheet-no. 1628
AOC = visual, see sheet-no. 1606, VS1 = electrical, see sheet-no. 1607
AE = visual-electrical, see sheet-no. 1609, VS2 = electrical, see sheet-no. 1608
- 13 shut-off valve:
- = without, AV = shut-off valve, see sheet-no. 1655
- 14 specification pressure vessel:
- = standard (PED 97/23/EC)
IS20 = ASME VIII Div.1 with ASME equivalent material, see sheet-no. 55217
IS21 = ASME VIII Div.1 with U-stamp, see sheet-no. 43415
IS23 = ASME VIII Div.1 without U-stamp, see sheet-no. 55218
- 15 switch lever:
F = toward IN/O
B = opposite IN/OUT
- 16 air bleeding/drain:
F = toward IN/OUT,
B = opposite IN/OUT

1.2. Filter element: (ordering example)

01NR. 1000. 10VG. 10. B. P. VA

1	2	3	4	5	6	7
---	---	---	---	---	---	---

- 1 series:
01NR. = standard-return-line filter element according to DIN 24550, T4
- 2 nominal size: 1000
- 3 - 7 see type index complete filter

weight: approx. 915 lbs.

Changes of measures and design are subject to alteration!

1) Connection for the potential equalisation at inlet and outlet, only for application in the explosive area.

Position I: Filter 1 in operation
Position II: Filter 2 in operation

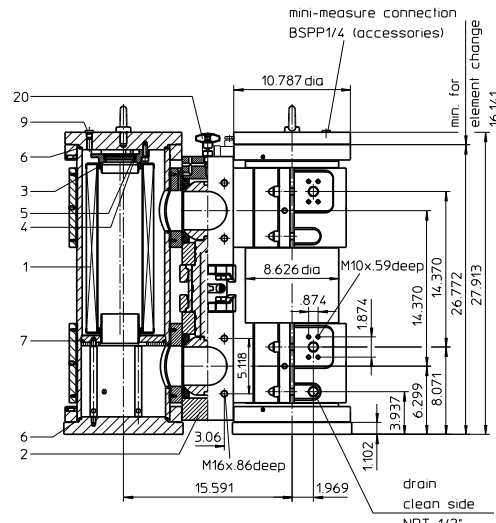
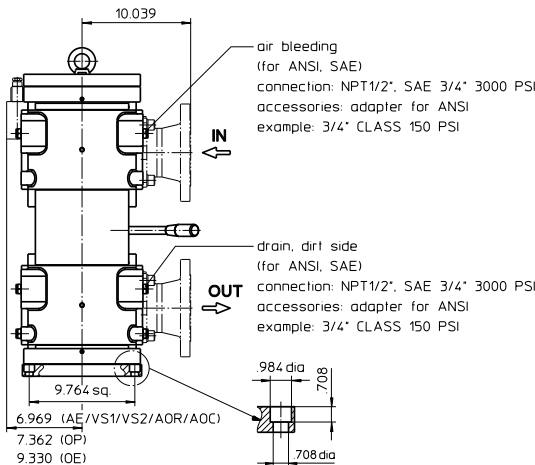
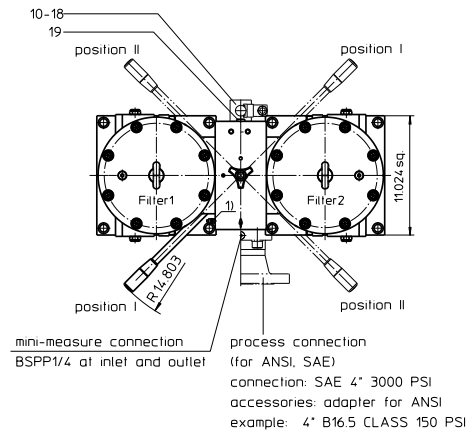

2. Accessories:

- SAE-counter flanges, see sheet-no. 1652
- adapter for ANSI-connection B16.5 CLASS 150 PSI, see sheet-no. 1658
- measure- and bleeder-connections, see sheet-no. 1650
- drain- and bleeder connection, see sheet-no. 1659

3. Spare parts:

item	qty.	designation	dimension	article-no.	
1	2	filter element	01NR.1000 ...		
2	1	change over UKK	4"		
3	4	O-ring	90 x 4	306941 (NBR)	307031 (FPM)
4	2	O-ring	62 x 4	308045 (NBR)	311472 (FPM)
5	2	circlip	DIN472-75x2,5-1.4310	318481	
6	4	O-ring	200 x 4	334555 (NBR)	334554 (FPM)
7	2	O-ring	185 x 6	335381 (NBR)	335306 (FPM)
8	12	screw plug	NPT 1/2"	307766	
9	2	screw plug	BSPP 1/4"	306968	
10	1	clogging indicator, visual	AOR or AOC	see sheet-no. 1606	
11	1	clogging indicator, visual-electrical	OP	see sheet-no. 1628	
12	1	clogging indicator, visual-electrical	OE	see sheet-no. 1628	
13	1	clogging indicator, visual-electrical	AE	see sheet-no. 1609	
14	1	clogging sensor, electronical	VS1	see sheet-no. 1607	
15	1	clogging sensor, electronical	VS2	see sheet-no. 1608	
16	1	O-ring	15 x 1,5	315357 (NBR)	315427 (FPM)
17	1	O-ring	22 x 2	304708 (NBR)	304721 (FPM)
18	2	O-ring	14 x 2	304342 (NBR)	304722 (FPM)
19	2	screw plug	BSPP 1/4"	306968	
20	1	pressure balance valve	3/8"	310316	

item 19 execution only with clogging indicator or clogging sensor

4. Description:

Stainless steel-pressure filters, change-over series EDA 1015 are suitable for operating pressure up to 580 PSI.

Pressure peaks can be absorbed with a sufficient margin of safety.

Change-over ball valve which, integrated in the middle of the housing, makes it possible to switch from the dirty filter-side to the clean filter-side without interrupting operation.

The filter element consists of star-shaped, pleated filter material which is supported on the inside by a perforated core tube and is bonded to the end caps with a high-quality adhesive. The flow direction is from outside to the inside.

These filters can be installed as suction filters.

For cleaning (see special leaflet 21070-4 and 34448-4) the mesh element respectively to change the glass fiber element remove the cover and take out the element.

Filter finer than 40 µm should use throw-away elements made of paper or Interpor fleece (glass fiber). Filter elements as fine as 5 µm are available; finer filter elements on request.

Internormen Product Line filter elements are known as elements with a high intrinsic stability and an excellent filtration capability, a high dirt-retaining capacity and a long service life.

Internormen Product Line filter are suitable for all petroleum based fluids, HW-emulsions, most synthetic hydraulic fluids and lubrication oils.

The inspection according to TÜV, according to ASME VIII Div.1 and the major „Shipyards Classification Societies“ D.N.V.; B.V.; G.L.; L.R.S.; R.I.N.A.; A.B.S. and others are possible. If inspection is required please indicate in your order.

5. Technical data:

temperature ranges	
- calculation temperature (pressure vessel):	+14°F to +212°F
- medium temperature:	+14°F to +176°F
- ambient temperature:	- 40°F to +140°F
- survival temperature:	- 40°F to +212°F (short-time)
operating medium:	mineral oil, other media on request
max. operating pressure:	580 PSI
test pressure acc. to PED 97/23/EC:	1,43 x operating pressure = 827 PSI
test pressure acc. to ASME VIII Div. 1:	1,3 x operating pressure = 754 PSI
test pressure acc. to API 614, Chapter 1:	1,5 x operating pressure = 870 PSI
connection system:	SAE-flange connection 3000 PSI
housing material:	stainless steel, see sheet-no. 55050
sealing material:	Nitrile (NBR) or Viton (FPM), other materials on request
installation position:	vertical
bleeder connection :	NPT 1/2" and SAE 3/4" 3000 PSI
drain connection dirt side :	NPT 1/2" and SAE 3/4" 3000 PSI
drain connection clean side :	NPT 1/2"
volume tank :	2x 5.02 Gal.
operating pressure adapter flanges:	according to B16.5 CLASS 150 PSI

Classified under the Pressure Equipment Directive 97/23/EC for mineral oil (fluid group 2), Article 3, Para. 3.

Classified under ATEX Directive 94/9/EC according to specific application (see questionnaire sheet-no. 34279-4)

6. Symbols:

without indicator

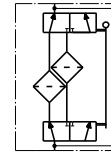

with shut-off valve

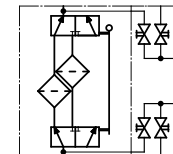

with by-pass valve

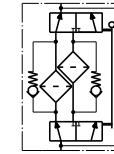

with electrical indicator
AE 30 and AE 40

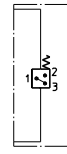

with visual-electrical indicator
AE 50 and AE 62

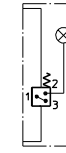

with visual-electrical indicator
AE 70 and AE 80

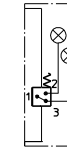

with visual indicator
AOR/AOC/OP

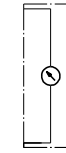

with visual-electrical indicator
OE

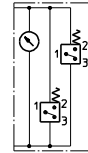

with electronical sensor
VS1

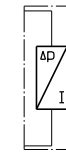

with electronical sensor
VS2



7. Pressure drop flow curves:

Precise flow rates see 'Interactive Product Specifier', respectively Δp- curves; depending on filter fineness and viscosity.

8. Test methods:

Filter elements are tested according to the following ISO standards:

ISO 2941	Verification of collapse/burst resistance
ISO 2942	Verification of fabrication integrity
ISO 2943	Verification of material compatibility with fluids
ISO 3723	Method for end load test
ISO 3724	Verification of flow fatigue characteristics
ISO 3968	Evaluation of pressure drop versus flow characteristics
ISO 16889	Multi-pass method for evaluating filtration performance